



## DGIWG 109

### Portrayal Standard for Multinational Geospatial Co-production Program (MGCP) Data

**Document type:** Standard

**Document date:** 29 May 2015

**Edition:** 2.0.1

**Responsible Party:** MGCP and DGIWG

**Audience:** This document is approved for public release and is available to the public via <http://www.dgiwg.org/dgiwg/>.

**Abstract:** This standard defines the portrayal symbols and rulesets used to generate graphics from data collected in accordance with Multinational Geospatial Co-production Program (MGCP) technical reference documents.

Note: This document supersedes DGIWG 109 Ed. 1, 17 November 2009

**Copyright:** (C) Copyright, some rights reserved - (CC) Attribution-

You are free:

- To copy, distribute, display, and perform/execute the work
- To make derivative works
- To make commercial use of the work

Under the following conditions:

- (By:) Attribution. You must give the original authors credit.
- For any reuse or distribution, you must make clear to others the license terms of this work.

Any of these conditions can be waived if you get permission from the copyright holders.

Your fair use and other rights are in no way affected by the above.

This is a human-readable summary of the Legal Code (the full license is available from Creative Commons <<http://creativecommons.org/licenses/by/2.0/>>).

---

## Document history

Version	Date	Comments	Authors
2.0.0 (Publication Draft)	15 May 2015	Revision of DGIWG Portrayal Standard for MGCP Data, v1.0, 17 November, 2009.	MGCP
2.0.1	29 May 2015	Final publication version of DGIWG Portrayal Standard for MGCP Data, v2.0.1, 29 May 2015. Corrections and revisions were made to the 15 May v2.0.0 Publication Draft, to include: adjustment of footer in Annex A to correct suppressed label strings; addition/deletion of GC and LP rules on several features; addition of "Rapids" label to Rapids line and point symbol samples; addition of new symbol (PS-04133) for Tower/non-obstruction/control (point); addition of a "List of Figures and Tables".	MGCP

## Table of Contents

1	Introduction .....	4
2	Scope.....	4
3	Conformance.....	5
4	Normative references .....	5
5	Portrayal Standard Report Organization .....	6
6	Feature Symbols Report (Annex A) .....	6
6.1	Feature Information .....	6
6.2	Generalization Rules .....	7
6.3	Symbol Description .....	8
6.4	Symbol Component .....	9
6.5	Symbol Rules.....	11
6.6	Label Rules .....	13
6.7	Symbol Samples .....	16
6.8	Color.....	17
6.9	Type Fonts.....	18
6.10	Masking .....	20
	Annex A – Feature Symbols .....	A-i
	Annex B – Feature Symbol Quick Reference Guide .....	B-i
	Annex C – Color .....	C-i
	Annex D - Text Characteristics.....	D-i
	Annex E – Area Components .....	E-i
	Annex F – Line Components .....	F-i
	Annex G – Point Components.....	G-i
	Annex H – Detailed Drawing Instructions.....	H-i
	Annex I – Patterns.....	I-i
	Annex J – Generalization and Label Rules .....	J-i
	Annex K – Glossary .....	K-i
	Annex L – Feature Symbol Index .....	L-i

## List of Figures and Tables

FIGURE 1. FEATURE HEADER AND GENERALIZATION RULES FROM ANNEX A .....	7
FIGURE 2. SYMBOL DESCRIPTION FROM ANNEX A .....	8
FIGURE 3. SYMBOL RULE FROM ANNEX A .....	11
FIGURE 4. SYMBOL RULE FROM ANNEX A WITH ALL CRITERIA.....	11
FIGURE 5. MULTIPLE SYMBOLS AND RULES FOR ONE FEATURE FROM ANNEX A .....	12
FIGURE 6. LABEL RULES FROM ANNEX A .....	13
FIGURE 7. SYMBOL SAMPLES FROM ANNEX A.....	16
FIGURE 8. SAMPLE OF AREA FEATURE WITH LABEL SHOWN OUTSIDE THE AREA.....	16
FIGURE 9. SAMPLE OF AREA FEATURE WITH LABEL SHOWN OUTSIDE THE AREA.....	16
FIGURE 10. SAMPLE OF LINE FEATURE LABEL .....	17
FIGURE 11. SAMPLE OF POINT FEATURE LABEL.....	17
TABLE 1. ATTRIBUTE DIMENSIONS FOR 1:50,000 AND 1:100,000 SCALE TOPOGRAPHIC MAPS.....	7
TABLE 2. FONT MAPPING.....	19

## 1 Introduction

The Multinational Geospatial Co-production Program (MGCP) is a multinational program to collect geospatial data worldwide, concentrating on areas where little data currently exists.

MGCP data is collected in accordance with the standards established in the MGCP Technical Reference Documentation, Version 4 (TRD4) and any related subversions, i.e. v4.1, v4.2, etc. This establishes a MGCP Data Content Specification defined by a Feature Catalogue, an Extraction Guide, a Metadata and a Data Quality Standard. The MGCP Program has a remit for data collection rather than the portrayal of that data or product development.

This standard was developed by the Multinational Geospatial Co-production Program - Technical Group (MGCP-TG) in order for vendors and producers to ultimately portray MGCP data within a TRD4 schema on a hardcopy 1:50,000 or 1:100,000 topographic map.

The standard provides symbol rules that associate geospatial feature/attribute data instances from the MGCP TRD4 Feature Catalogue with agreed symbol specifications.

It also provides supplementary non-MGCP feature content and associated agreed symbol specifications required to develop content requirements to produce a topographic map.

This standard supersedes DGIWG 109, Portrayal Standard for MGCP Data, Edition 1.0, 17 November 2009.

Recommendations for improving this standard should be sent to the Multinational Geospatial Co-production Program - Technical Group (MGCP-TG) Chair for consideration.

## 2 Scope

The scope of this standard is to provide portrayal information and graphic symbols for the agreed upon required Real World Objects to be portrayed on a topographic map. It also provides the Symbol Rules encoding for portraying MGCP TRD4 Data.

A Real World Object is a unique item that requires a portrayal. These can constitute a Feature Class (e.g. Railway) or a specific Feature Class/Attribute combination (e.g. a not intact Railway) from a given Feature Catalogue.

Portrayal information consists of symbol rules (which associate data to symbols) and symbol specifications (that define symbols).

Symbol Rules for Real World Objects sourced from MGCP TRD4 Data are encoded in conformance to DGIWG Feature Data Dictionary (DFDD), Baseline 2010-2 and the MGCP TRD4 Feature Catalogue Standard.

Symbol Rules for supplementary Real World Objects not sourced from MGCP Data, i.e. administrative/geopolitical boundaries and elevation data, are encoded in conformance to the DGIWG Feature Data Dictionary (DFDD), Baseline 2013-1.

The Symbol Graphics defined in this specification have been coordinated and agreed upon with DGIWG and constitute the standard symbol for the designated Real World Object in the DGIWG 50K Hardcopy Symbol Library.

The Symbol Specifications in this standard may be implemented independently by vendors in their own systems subject to conformance below. Vendors may need to create their own Symbol Rules as appropriate depending on the Data Dictionary and Feature Catalogue standards used.

### 3 Conformance

For symbols to conform to this standard they must meet the following criteria.

- Symbols shall be “visually equivalent” to those symbol graphics in the standard. Visually equivalent symbols are those that would be recognized by users as representing the same feature or information.
- Symbols on actual maps shall conform to the delineation of the geospatial feature (area, line, point). Shapes shown in this standard are representative examples only.
- All labels shall be shown in accordance with this standard. Conditional attribute labels will be filled in with the applicable information associated with the feature instance rather than the generic attribute labels shown in the standard.
- Colors on printed maps shall be in accordance with Annex C – Color.

### 4 Normative references

This document references several other documents for additional information:

- a. Multinational Geospatial Co-production Program (MGCP) Technical Reference Documentation (TRD) v4 [MGCP 2014].
- b. DGIWG Feature Data Dictionary (DFDD), Baseline 2010-2 [DGIWG 2010].
- c. DGIWG Feature Data Dictionary (DFDD), Baseline 2013-1 [DGIWG 2013].
- d. DGIWG 50K Hardcopy Symbol Library [DGIWG 2015].
- e. Data Product Specification (DPS), 1:50,000 and 1:100,000 Scale Topographic Map (TM) – Portrayal Catalog (TM PC), v1.0 [NGA 2015].
- f. MIL-STD-2410, Mapping, Charting, and Geodesy (MC&G) Reproduction and Printing [DMA 1995].
- g. Pantone Colors - Information on Pantone colors is available at <http://www.pantone.com>
- h. Standard Printing Color Catalog for Mapping, Charting, Geodetic Data and Related Products [US DoD 1987].

- i. NGA DBGI Color.doc [NGA 2008].

## 5 Portrayal Standard Report Organization

The MGCP Portrayal Standard report is organized into the following annexes:

- Annex A – Feature Symbols: provides feature portrayal information, sorted alphabetically by feature name. Subsequent annexes provide additional supporting information and are described therein.
- Annex B – Feature Symbol Quick Reference Guide: provides users with an overall view of example symbols for each feature type, as well as serve as an index to assist users in locating the detailed specifications for symbols in Annex A.
- Annex C – Color: defines the colors used in the Portrayal Standard in several well-known color specification methodologies.
- Annex D – Text Characteristics: defines the characteristics of the text used for labels on feature symbols in Annex A.
- Annex E – Area Components: lists each of the area components used in Annex A.
- Annex F – Line Components: lists each of the line components used in Annex A.
- Annex G – Point Components: lists each of the point components used in Annex A.
- Annex H – Detailed Drawing Instructions: provides the detailed specifications for reusable graphic icons used in Annex A.
- Annex I – Patterns: provides examples of the area patterns used for feature symbols in Annex A.
- Annex J –Generalization and Label Rules: provides the content of the generalization and label rules that are assigned to features and symbols in Annex A.
- Annex K – Glossary: provides definitions for many of the terms used in the Portrayal Standard.
- Annex L – Feature Symbol Index: provides an index of features in Annex A, sorted by feature/alternate name, and feature code.

## 6 Feature Symbols Report (Annex A)

### 6.1 Feature Information

Each feature contained in the MGCP Portrayal Standard is identified by a yellow header that provides the name of the feature and the feature code (Figure 1). There are also some non-features (deemed as “No Code”) that are included in the Portrayal Standard. These no code features are included as placeholder symbols for use during product finishing as needed - Leader Line, Point of Change, River Flow Arrow, Road Route Marker, and Vertical Obstruction.

**General Building (AL015)**

Generalization Rules (see Annex J): GA-9999, GC-9978, GC-9983, GC-9994

Figure 1. Feature header and Generalization Rules from Annex A

**6.2 Generalization Rules**

Generalization rules are used to adjust or reassign the display space delineation of a map feature for the purpose of achieving the desired cartographic result. The generalization rule category designators are:

**GA** – Generalization Aggregation rules blend or combine identical contiguous features.

**GC** – Generalization Change rules indicate when a geometry will be altered or changed from one delineation to another. These rules may also include dimensional conversion guidance to derive symbols for both a 1:50,000 and 1:100,000 scale topographic map (see Table 1).

The Generalization Aggregation (GA) rules should be applied first, before applying the Generalization Change (GC) rules. The generalization rules are listed by their specific rule number (GA-XXXX or GC-XXXX) directly below the feature header (Figure 1) and are defined in Annex J.

**6.2.1 Scale**

Table 1 can be used as a quick reference for dimensional attribute (area [ARA], length [LEN], width [WID]) conversions between 1:50,000 and 1:100,000 scales.

Scale	ARA	ARA	ARA	ARA	ARA	ARA	ARA	ARA	ARA
50,000	625	1,600	2,500	5,625	8,125	15,625	62,500	360,000	1,000,000
100,000	2,500	6,400	10,000	22,500	32,500	62,500	250,000	1,400,000	4,000,000

Scale	LEN	LEN	LEN	LEN	LEN	LEN	LEN	LEN
50,000	10	20	25	50	75	100	125	375
100,000	20	40	50	100	150	200	250	750

Scale	WID	WID	WID	WID	WID	WID
50,000	25	40	50	65	75	100
100,000	50	80	100	130	150	200

Table 1. Attribute dimensions for 1:50,000 and 1:100,000 Scale Topographic Maps



### 6.3 Symbol Description

The Symbol Description section provides detailed information about the symbol graphic specifications and how it is constructed (Figure 2).



Figure 2. Symbol Description from Annex A

#### 6.3.1 Symbol Name

Each symbol in Annex A is identified by a blue header that provides the name of the feature, any attribution information used to further identify the symbol (if applicable), and the geometry of the symbol (area, line or point). Examples of attribution information are “Intact”, “Not Intact”, “Obstruction” and “Non-obstruction”. Note: The term “Not intact” indicates the [FUN] enumerant values of “Abandoned”, “Damaged”, “Destroyed”, “Dismantled” and “Under Construction” (those not deemed “Fully Functional”).

#### 6.3.2 Symbol Graphic

Each symbol contains a “Symbol Graphic”. The graphic is intended to give a general representation of the symbol’s appearance in order to better understand the specifications needed to construct it. Many of the graphics are shown in an enlarged size compared to what would appear on a topographic map. This enlargement was made in order to make the components of the symbol graphic more visible.

#### 6.3.3 Symbol Placement Instructions

The symbol placement instructions provide basic information on how the symbol is to be placed in relation to its geometry.

### 6.3.4 Symbol Type

A symbol can be classified as either complex, compound or simple. Complex and compound symbols are composed of more than one symbol component, while simple symbols are composed of only one symbol component. Complex symbols are made-up of symbol components with different geometries (e.g. Built-up Area with an area-fill and perimeter line component). Compound symbols are made-up of symbol components with the same geometry (e.g. Wood/evergreen with two area-fill components).

### 6.3.5 Repeating Point and Interval

This section (if applicable) provides detailed specifications for symbols that have a point component(s) that repeats at certain intervals along a line. Those symbols that contain 2 different repeating point components will be referenced with a “Repeating Point and Interval 2” note.

### 6.3.6 Note

The Note section (if applicable) provides instruction on how the symbol is to be constructed as a group of components. It may also contain other miscellaneous symbol information as needed.

## 6.4 Symbol Component

For each symbol component, the following information is provided (see Figure 2):

- Component Reference # – A unique identifier for each component in the Portrayal Standard.
- Component Type – Identifies whether the component is an area, line, or point. The types may be further detailed as Area-Fill, Line-Styled, Point-Simple, etc. Elements of these component types are provided in subsequent paragraphs.
- Color Token(s) – A name describing the color(s) to apply to the symbol component.
- Description – A textual description of the component.
- Parameters – The specifications for the symbol component. Specific information is dependent on what type of symbol component is involved.

The Parameters section provides the basic specifications needed to construct the component. A “Note” may be included to provide additional instruction and/or how the component is placed in relation to its geometry. The following standard parameters are used to specify the various elements or instructions for the different Component Types.

### 6.4.1 Point – Simple

The Point – Simple component can be defined by the following parameters:

- Diameter
- Length
- Line Weight
- Note

### **6.4.2 Point – Shape**

The Point – Shape component is defined by parameters listed in Annex H, which also contains detailed drawing instructions.

### **6.4.3 Line – Simple**

The Line – Simple component can be defined by the following parameters:

- Line Weight
- Screen Angle
- Screen Percent
- Note

### **6.4.4 Line – Styled**

The Line – Styled component can be defined by the following parameters:

- Line Weight
- Dash Length
- Dash 2 Length
- Dash 3 Length
- Dash Spacing
- Dash 2 Spacing
- Dash 3 Spacing
- Screen Angle
- Screen Percent
- Note

### **6.4.5 Area – Fill**

The Area - Fill component can be defined by the following parameters:

- Screen Angle
- Screen Percent
- Note

### **6.4.6 Area – Pattern**

The Area - Pattern component can be defined by the following parameters:

- Area Pattern
- Screen Angle
- Screen Percent
- Note

### 6.4.7 Order of colors and “painters model”

Many symbols are constructed by combining several different symbol components. Where different colored components are overprinted to obtain the desired effect, a “painter’s model” may be used to specify the symbol. In the painter’s model, the component specified first will be overwritten by components that follow. For example: Road / intact / divided / narrow median (see Figure 2), is specified by a thick black line, overprinted with a less thick dark brown line, followed by another thin black line, which ultimately produces the black “cased” portion of the road symbol. The painter’s model in this standard is intended only to describe the symbol. A different implementation may be required for actual map production. In lithographic printing, for example, the thick black line would obscure anything else printed on top of it.

## 6.5 Symbol Rules

The Symbol Rules section provides the symbol rule information for the preceding symbol description. Symbol rules are rules that indicate the condition in which the symbol is selected. They associate an instance of geospatial data with a particular symbol. Attributes and enumerants included in the Criteria field are based on DGIWG Feature Data Dictionary (DFDD) and appear in both text and code (Figure 3).

Symbol Rules		
Reference #:	Description:	Criteria:
PS-04131	Bridge / non-fixed / non-pedestrian (line)	Bridge Opening Type [BOT] = (Bascule [4], Lift-bridge [11], Retractable [12], Swing-bridge [10])  AND Transportation System Type [TRS] = (Aeronautical [1], Aqueduct [2], Bus [4], Canal [5], Maritime [7], Not Applicable [998], Other [999], Pipeline [10], Railway [12], Road [13], Unknown [0])

Figure 3. Symbol Rule from Annex A

### 6.5.1 Criteria for symbol portrayal

The Criteria column indicates what specific attribute conditions are required for that particular symbol. A special criterion of “ALL” has been created, which indicates that all instances of the feature/geometry will receive the same symbol (Figure 4).

Symbol Rules		
Reference #:	Description:	Criteria:
PS-04705	Culvert / all (point)	All

Figure 4. Symbol Rule from Annex A with ALL Criteria

### 6.5.2 Features with more than one possible symbol

When a feature has more than one possible symbol (e.g. Wood), more than one symbol rule will exist for that feature. A symbol instance should match one and only one criterion (Figure 5).

**Wood / evergreen (area)**



Symbol Graphic

**Symbol Placement Instructions:** The symbol is applied to the geometry of the feature.

**Symbol Type:** Compound

**Note:** Components A00009 and A00012 are combined into one symbol. Display level from bottom to top: Component A00009; Component A00012.

---

<b>Component Ref #:</b>	A00009	<b>Component Type:</b>	Area - Fill	<b>Color Token:</b>	Green362-31
<b>Description:</b>	Green362-31 area Fill (Green362 31% screen, 45 degree angle)				
<b>Parameters:</b>					
<b>Screen Angle:</b>	45 degrees				
<b>Screen Percent:</b>	31%				

---

<b>Component Ref #:</b>	A00012	<b>Component Type:</b>	Area - Pattern	<b>Color Token:</b>	Green362
<b>Description:</b>	Green362 EvergreenTreeFill area pattern				
<b>Parameters:</b>					
<b>Area Pattern:</b>	AP-60, see Annex I				

**Symbol Rules**

<b>Reference #:</b>	<b>Description:</b>	<b>Criteria:</b>
PS-04796	Wood / evergreen (area)	Canopy Cover [DMT] >= 51
		AND Foliage Type [TRE] = Evergreen [2]

---

**Wood / mixed (area)**



Symbol Graphic

**Symbol Placement Instructions:** The symbol is applied to the geometry of the feature.

**Symbol Type:** Compound

**Note:** Components A00009 and A00013 are combined into one symbol. Display level from bottom to top: Component A00009; Component A00013.

---

<b>Component Ref #:</b>	A00009	<b>Component Type:</b>	Area - Fill	<b>Color Token:</b>	Green362-31
<b>Description:</b>	Green362-31 area Fill (Green362 31% screen, 45 degree angle)				
<b>Parameters:</b>					
<b>Screen Angle:</b>	45 degrees				
<b>Screen Percent:</b>	31%				

---

<b>Component Ref #:</b>	A00013	<b>Component Type:</b>	Area - Pattern	<b>Color Token:</b>	Green362
<b>Description:</b>	Green362 MixedTreeFill area pattern				
<b>Parameters:</b>					
<b>Area Pattern:</b>	AP-63, see Annex I				

**Symbol Rules**

<b>Reference #:</b>	<b>Description:</b>	<b>Criteria:</b>
PS-04798	Wood / mixed (area)	Canopy Cover [DMT] >= 51
		AND Foliage Type [TRE] = Mixed [3]

Figure 5. Multiple symbols and rules for one feature from Annex A

### 6.5.3 Symbol rule information

The symbol rule information is presented and defined as follows:

- Reference # – Static unique identifier associated with the symbol rule. Used to link the entry to entries in other Annexes.
- Description – Textual description of the symbol rule (matches the Symbol Name).
- Criteria – Indicates what specific attribute conditions are required for that particular symbol.

### 6.5.4 Symbol rule syntax

The syntax utilized in the symbol rule criteria is based on the Structured Query Language (SQL) and thereby is easily interpreted by implementation software applications. Attribute names and enumerants are indicated by text and their corresponding codes.

Operators are generally defined as follows:

- = is equal
- <> is not equal
- > greater than
- < less than
- >= greater than or equal
- <= less than or equal

Other syntax operators:

- ( ) used to group like attributes or indicate precedence
- or indicates true if at least one of the conditions is true
- and indicates true if all conditions are true

### 6.6 Label Rules

Labeling can be used to identify or assist in identification of the meaning of symbols, and also may supply additional information about the feature being portrayed. Labeling requirements for symbols are identified in the Label Rules section for each symbol (Figure 6). If the Label Rules section is not present, then a label is not required for that symbol.

Label Placement Rules (see Annex J):		Label Rules
	LP-3506, LP-4813, LP-9999	
<b>Reference #:</b>	<b>Description:</b>	<b>Criteria:</b>
PL-04726_1	<b>Communication Station / intact (area)</b> Label String: "Communication station" Characteristics: 1 1 (Black, Condensed, 6 pt, Mixed case)	Condition of Facility [FUN] = (Fully Functional [6], Unknown [0])
PL-04726_2	<b>Communication Station / not intact (area)</b> Label String: "Communication station" "["[Condition of Facility]" Characteristics: 1, 22, 22, 22 1 (Black, Condensed, 6 pt, Mixed case) 22 (Black, Condensed, 6 pt, Lower case)	Condition of Facility [FUN] = (Abandoned [2], Damaged [13], Destroyed [3], Dismantled [4], Under Construction [1])

Figure 6. Label Rules from Annex A

#### 6.6.1 Label Placement rules

Label Placement (LP) rules are used to provide the initial baseline type placement for the rendered portrayal of an applicable symbol. LP rules are listed by their specific rule number (LP-XXXX) for each applicable symbol in Annex A and are defined in Annex J.

## 6.6.2 Label Rule information

The label rule information is presented and defined as follows:

- Reference # – Static unique identifier associated with the label rule.
- Description – Textual description of the label placement rule.
- Criteria – Criteria to further refine the label placement. This is in addition to the symbol rule.
- Label String – The content(s) of the label listed in sequence, which can be fixed text, variable label portraying attribute, varying label derived from attribute, or a combination of these.
- Characteristics – A type style code for each label in the label string in sequence. This is followed by an explanation of the code. A listing of text characteristic codes is included in Annex D.

## 6.6.3 Types of labels

Labels can be of the following types:

- Fixed label – the symbol has a label, and the content of the label is fixed, for example, the label “Falls” on a Waterfall, or “Rest area” on a Roadside Rest Area.
- Variable label portraying attribute – the content of the label changes, depending on attribute information being portrayed. An example would be showing the [Product] label on an Extraction Mine, such as “Coal”, “Diamond”, “Gold”, “Lead”, etc. Another example would be to show the [Name] of a feature as a label, for example, “Olympic Stadium”, or “Central Park”.
- Variable label derived from attribute – the content of a label changes based on the attribute information, but the text of the label is not the attribute value. An example would be a Fairgrounds with [Name] = “Unknown” being labeled simply as “Fairgrounds”.
- Combination – a series of labels of the various types listed above.

## 6.6.4 Modification of label strings based on attribution

Note that in some cases, the label string may have to be modified depending on whether attribute information is portrayed. For example, if a label string is made up of a variable or attribute based element and a static element, then it wouldn't make sense to have the label “Unknown” or “Other” for the variable portion. In these cases, the variable portion should be omitted rather than place the label containing an attribute based portion such as “Unknown” on the symbol. When concatenating multiple static or dynamic label string elements into a single label string, each static or dynamic label string element is separated from the next element by a single space.

## 6.6.5 Attribute enumerants not intended for labelling

Attribute values that are not intended to be labeled include:

- Unknown [0]
- Multiple [996]
- Not Populated [997]
- Not Applicable [998]

- Other [999]

If an attribute is Unknown [0] or has not been collected, the label is also not shown. Examples of these types of attributes are Height Above Surface Level [HGT], Railway Gauge [GAW], Track or Lane Count [LTN], or Name [NAM].

### **6.6.6 Text [TXT] attribute**

Whenever the Other [999] enumerant for any feature attribute is selected, the Text [TXT] attribute for that feature should be populated. Since the text entered for the [TXT] attribute can refer to the Other [999] enumerant of one or more attributes, no rule can determine if or how the text should be used. However, the text should be considered for potential feature labelling where applicable.

### **6.6.7 Text Characteristics**

The Text Characteristics table in Annex D contains information specific to the text characters. This information contains color, size, case, and style parameters.

#### **6.6.7.1 Text Characteristic parameters**

The parameters for text characteristics are specified as follows:

- Text Characteristic # - Reference to link the characteristics to the Label Rule information in Annex A.
- Color Token – Color Token for the label string.
- Font Style – Indication of Condensed, Light Condensed, or Regular.
- Style – Indication of Bold or Italics.
- Font Size -- Point (PT) size of the label string.
- Case – Indication of capitalization. Valid values are Upper case, Lower case, and Mixed case.

#### **6.6.7.2 Substitution of type size**

When space prohibits the use of a prescribed type size, a more appropriate size may be selected by the cartographer.

#### **6.6.7.3 Capitalization of label information**

Capitalization of label information on a symbol follows the general structure below:

- The first letter is capitalized, for example, “Falls”.
- For multiple words in a descriptive label, the first letter of the first word is capitalized, for example, “Chemical processing facility” or “Water pumping station”.
- For proper names, the first letter in each word is capitalized, for example, “Yellowstone National Park”.



### 6.6.7.4 Additional named features

Topographic maps may contain names that are not necessarily extracted and/or symbolized as distinct feature entities. Examples of named “features” included in this category are: dispersed and scattered villages, farmsteads, suburban areas, mountains, mountain ranges, mesas, ridges, valleys, plains, canyons, peaks, hills, capes, points, peninsulas, inlets, etc. Refer to Annex D for the recommended text characteristics of these additional named features (or similar features as appropriate). Label placement rule LP-0050 shall be used to determine the appropriate size of text based on the size of the feature at map scale.

## 6.7 Symbol Samples

The MGCP Portrayal Standard also provides “Symbol Samples” at the 1:50,000 map scale. The first graphic is a sample of the basic symbol as it would appear on a map. The second and third graphics show possible label examples or relationships to features closely associated with the symbol (Figure 7).

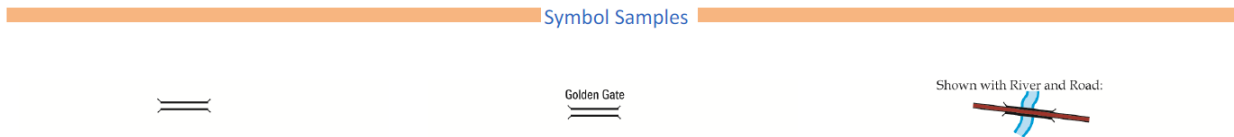

Figure 7. Symbol Samples from Annex A

### 6.7.1 Baseline Label Placement samples

The symbol samples shown in Annex A also provide an initial baseline label placement (using LP rules) for the rendered portrayal of an applicable symbol (see Figure 8 – Figure 11). Variation from this default placement may be required (via the use of subsequent product finishing rules) in order to resolve overprints and otherwise achieve the desired map readability.



Figure 8. Sample of area feature with label shown outside the area



Figure 9. Sample of area feature with label shown outside the area



Figure 10. Sample of line feature label.



Figure 11. Sample of point feature label

## 6.8 Color

A particular symbol may be a single color, or composed of multiple colors. Labels are generally specified in one color.

### 6.8.1 Methodologies for defining colors

Colors can be specified using several methodologies:

- U.S. Department of Defense Standard Printing Color Catalog for Mapping, Charting, Geodetic Data and Related Products, referred to as “SPC”, is a methodology used in the U.S DoD to specify “spot” colors, which are unique mixtures of inks.
- Pantone colors – Pantone colors are commonly used in the printing industry and are based on specific mixes of inks. They are sometimes referred to as “spot” colors. Each pantone color has an identifier assigned to it. Information on Pantone colors is available at <http://www.pantone.com>.
- CMYK – Identifies the percentage of Cyan, Magenta, Yellow and Black (key) that is used to generate a specific color in process lithographic printing. Process printing allows a wide variety of colors to be produced from these three primary colors and the black.

### 6.8.2 Color tokens

The Color Token definitions utilized for this standard are provided in Annex C. This Annex provides a mapping from a specific color token to Pantone color names, to SPC ink colors, and to CMYK values. This mapping allows considerable flexibility in specifying equivalent colors in a variety of methodologies.

Color tokens are used to specify generic names of colors for symbol components. Color tokens can be replaced with different tokens if maps require different viewing conditions. For example, different viewing conditions may be required for red-light readable, or red and blue/green-light readable.

The use of a Color Token methodology provides for the greatest degree of flexibility at implementation to provide for an easy adaptation to various color needs. It further allows for colors to be defined by the software applications as necessary to fulfill product requirements.

Colors in Annex A and Annex D are specified for each symbol component by Color Token. Annex C provides a listing of Pantone colors, SPC ink colors, and CMYK values that are applicable to the MGCP topographic map product. The color token values used in this Standard can be mapped to this table to determine the CMYK values (reference NGA DBGI Color.doc for additional information on color mapping equivalencies).

### **6.8.3 Specification of colors in digital exchange files**

When exchanging digital files of finished map products in Portable Document Format (PDF), it is important to note that specifying colors using the spot color channels in the PDF allows for much greater flexibility in the lithographic printing of the map. If colors are specified only in CMYK, then four-color process printing is the only printing option available and red-light or red and blue/green-light readability cannot be absolutely assured.

## **6.9 Type Fonts**

The TrueType Zurich font has been selected as the most appropriate font to represent the label information for the MGCP 50K product. The following criteria were considered in selecting the font:

- Format should be TrueType
- Must be compatible with the Windows environment
- Must be similar to Swiss742 fonts specified in the MIL-STD-2402 and MIL-STD-2410 (e.g. compatible with the colors, sizes, styles)
- Cost of the purchase of commercial fonts
- All the diacritic marks must be supported
- Extendable (must be possible to add new characters)

### **6.9.1 Use of commercial type fonts**

The analysis concluded that the standard should not be too rigid regarding the use of one or another font. Nevertheless, for avoiding problems with the diacritical marks, the best choice is to use commercial fonts of recognized brand. These have Unicode codification and, in general, support all the current idiomatic characters.

Secondly, the analysis included not only TrueType but also OpenType because to choose one font in particular would lead to extra cost depending on the national mapping work flow. Therefore, the standard should be as flexible as possible.

### 6.9.2 Use of OpenType font

OpenType will likely become the standard in the near future, given that OpenType has greater capabilities in complex writings (languages), extendable and advanced typography (kerning, and so on). However, some national mapping work flows are not yet fully compatible with the OpenType fonts. An example of this is what happens with the PDF/X standard. The fonts used in the document must be embedded in it, including the metric and the codification’s data. Under the 1.6 version, the OpenType fonts are not accepted by the PDF format.

### 6.9.3 Compatible equivalent type fonts

The Swiss742 font is one of the “sans serif” style types. The first step was to look for any commercial font available similar to the Swiss742 being, at least, TrueType specification. The digital format of the font was not available so the MIL-STD-2410 in PDF version was utilized for comparison. The main brands like Bitstream/Corel, Monotype and Linotype were taken into account. Even though the criterion of the MIL-STD-2410 was to choose a single font, it was determined that the output for paper maps is better if a set of diverse fonts is used. These are TrueType fonts and they produce a good balance of functionality and aesthetics.

Nevertheless, on the basis of these, a set of compatible or equivalent fonts can be established, and the producers may use them at will. Conversion tables must be as flexible and extendable as possible. Table 2, Font Mapping, provides a mapping from the Swiss742 to Zurich and Univers TrueType fonts.

Font	Style	To Zurich BT	Style	To Univers	Style
Swiss 742	Regular (Medium)	Zurich BT		Univers® 55	Roman
	<i>Italic</i>		<i>Italic</i>		<i>Roman Oblique</i>
	<b>Bold</b>		<b>Bold</b>	<b>Univers® 65</b>	<b>Bold</b>
	Condensed		Condensed	Univers® 57	Condensed
	<b>Bold Condensed</b>		<b>Bold Condensed</b>	<b>Univers® 67</b>	<b>Bold Condensed</b>
	Light Condensed		Light Condensed	Univers® 47	Light Condensed
	<i>Light Condensed Italic</i>		<i>Light Condensed Italic</i>		<i>Light Condensed Italic</i>

Table 2. Font Mapping

## 6.10 Masking

In this Portrayal Standard, there are a number of point components or symbols that have "open" or white areas. It is intended that underlying symbology (such as vegetation) would not show through any of these white openings, but rather the component would mask out underlying symbols, not allowing it to fill any of the open or white portions of the symbol. For example, the open or white portion of the Tower symbol would mask the underlying Built-up Area tint, not allowing it to fill any open portion of the Tower symbol.

The following is a complete listing of Component Reference numbers from Annex A containing an open or white area as part of the symbol.

P00009 Non-water well  
 P00010 Located object  
 P00012 Building hospital  
 P00018 Building temple  
 P00019 Building pagoda  
 P00022 Cairn  
 P00028 Vanishing point disappearing  
 P00030 Tree other  
 P00031 Building stupa  
 P00032 Natural pool intermittent  
 P00040 Qanat/Water well intermittent  
 P00048 Bridge non-fixed open circle  
 P00064 Volcano  
 P00071 Rock formation  
 P00079 Railway station  
 P00084 Extraction mine peat  
 P00089 Helipad at hospital  
 P00090 Helipad  
 P00103 Dolphin/Snag/Structural pile  
 P00108 Fortified building  
 P00111 Forest/curve  
 P00131 Crane  
 P00132 Building checkpoint  
 P00133 Dish aerial  
 P00135 Lighthouse  
 P00136 Memorial monument  
 P00137 Cooling tower  
 P00140 Smokestack  
 P00141 Tower non-communication  
 P00142 Water tower  
 P00143 Wind turbine  
 P00144 Windmill  
 P00145 Flare pipe  
 P00148 Water intake tower  
 P00155 Aerial/Tower communication  
 P00157 Salt evaporator

P00158 Road route marker motorway non-USA  
P00160 Road route marker local/secondary  
P00162 Rig inland  
P00163 Offshore construction  
P00165 Motor vehicle station  
P00168 Holding pen  
P00175 Dragons teeth  
P00179 Survey point geodetic  
P00184 Building minaret  
P00186 Building diplomatic  
P00198 Mooring mast  
P00202 Bridge not fixed  
P00206 Wreck  
P00238 Railway turntable  
P00257 Water aerodrome  
P00267 Road route marker international  
P00268 Road route marker national non-USA  
P00271 Cemetery/Tomb other  
P00275 Motor vehicle station symbol  
P00283 Surface bunker  
P00284 Hut  
P00285 Building diplomatic flag  
P00287 Cable/Communication line  
P00292 Vertical obstruction pylon  
P00294 Radio aid  
P00295 Aircraft revetment  
P00296 Building hospital symbol

## **Annex A – Feature Symbols**

This annex presents generalization rules, symbol graphics, symbol descriptions, symbol rules and label rules for MGCP feature portrayal. This information is sorted alphabetically by Feature Name.

A cross reference to DFDD-like Code and specific page locations are provided in the Feature Symbol Index (Annex L).

# Administrative Boundary (FA000)

Generalization Rules (see Annex J): GA-9999

## Administrative Boundary / international (line)

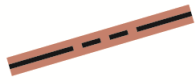

Symbol Graphic

**Symbol Placement Instructions:** The symbol is applied to the geometry of the feature.

**Symbol Type:** Compound

**Note:** Component L00123 is centered on Component L00122.

<b>Component Ref #:</b>	L00122	<b>Component Type:</b>	Line - Styled	<b>Color Token:</b>	Black
<b>Description:</b>	Black 0.5mm Dashed Line (0.5mm wt, 7.0mm dash, 2-2.0mm dashes, 1.0mm gaps)				
<b>Parameters:</b>					
<b>Line Weight:</b>	0.5mm	<b>Dash Length:</b>	7.0mm	<b>Dash Spacing:</b>	1.0mm
		<b>Dash 2 Length:</b>	2.0mm	<b>Dash 2 Spacing:</b>	1.0mm
		<b>Dash 3 Length:</b>	2.0mm	<b>Dash 3 Spacing:</b>	1.0mm
<b>Note:</b>	The line style is a 7.0mm dash, 1.0mm gap, 2.0mm dash, 1.0mm gap, 2.0mm dash, 1.0mm gap, then the pattern repeats.				

<b>Component Ref #:</b>	L00123	<b>Component Type:</b>	Line - Simple	<b>Color Token:</b>	Dk-Brown1815-54
<b>Description:</b>	Dk-Brown1815-54 2.0mm Screened Line				
<b>Parameters:</b>					
<b>Line Weight:</b>	2.0mm				
<b>Screen Angle:</b>	60 degrees				
<b>Screen Percent:</b>	54%				

### Symbol Rules

<b>Reference #:</b>	<b>Description:</b>	<b>Criteria:</b>
PS-04002	<b>Administrative Boundary / international (line)</b>	Geopolitical Line Type [LSP] = Generic International Boundary [17]
	AND	Boundary Status [BST] = (Definite [1], Indefinite [2], In Dispute [3], Other [999], Unknown [0])

### Label Rules

Label Placement Rules (see Annex J): LP-9995, LP-9999

<b>Reference #:</b>	<b>Description:</b>	<b>Criteria:</b>
PL-04002_1	<b>Administrative Boundary / international / definite (line)</b>	Boundary Status [BST] = (Definite [1], Other [999], Unknown [0])
	<b>Label String:</b>	[Name (first side)] [Name (second side)]
	<b>Characteristics:</b>	48 48 48 (Black, Condensed, Bold, 10 pt, Upper case)
PL-04002_2	<b>Administrative Boundary / international / indefinite, in dispute (line)</b>	Boundary Status [BST] = (Indefinite [2], In Dispute [3])
	<b>Label String:</b>	[Name1 (first side)] "["[Boundary Status]" [Name2 (second side)]
	<b>Characteristics:</b>	48, 48, 48, 48 48 48 (Black, Condensed, Bold, 10 pt, Upper case)

### Symbol Samples



## Administrative Boundary / other separation (line)



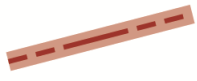

Symbol Graphic

Symbol Placement Instructions: The symbol is applied to the geometry of the feature.

Symbol Type: Compound

Note: Component L00126 is centered on Component L00253.

Component Ref #:	L00253	Component Type:	Line - Styled	Color Token:	Dk-Brown1815
Description:	Dk-Brown1815 0.5mm Dashed Line (0.5mm wt, 2-2.0mm dashes, 7.0mm dash, 1.0mm gaps)				
<a href="#">Parameters:</a>					
Line Weight:	0.5mm	Dash Length:	2.0mm	Dash Spacing:	1.0mm
		Dash 2 Length:	2.0mm	Dash 2 Spacing:	1.0mm
		Dash 3 Length:	7.0mm	Dash 3 Spacing:	1.0mm
Note:	The line style is a 2.0mm dash, 1.0mm gap, 2.0mm dash, 1.0mm gap, 7.0mm dash, 1.0mm gap, then the pattern repeats.				

Component Ref #:	L00126	Component Type:	Line - Simple	Color Token:	Dk-Brown1815-42
Description:	Dk-Brown1815-42 2.0mm Screened Line				
<a href="#">Parameters:</a>					
Line Weight:	2.0mm				
Screen Angle:	60 degrees				
Screen Percent:	42%				

### Symbol Rules

Reference #:	Description:	Criteria:
PS-04001	<b>Administrative Boundary / other separation (line)</b>	Geopolitical Line Type [LSP] = (Armistice Line [3], Cease Fire Line [7], Claim Line [9], Convention Line [8], Demarcation Line [5], Generic Administrative Boundary [1], Intercolonial Line [10], Interentity Line [11], Line of Adjacency [12], Line of Control [4], Line of Convenience [6], Line of Withdrawal [13], Military Disengagement Line [14], Other [999], Provisional Administrative Line [2], Treaty Line [15], UNCLOS Claim Boundary [16], Unknown [0])
	AND	Boundary Status [BST] = (Definite [1], Indefinite [2], In Dispute [3], Other [999], Unknown [0])

### Label Rules

Label Placement Rules (see Annex J): LP-9995, LP-9999

Reference #:	Description:	Criteria:
PL-04001_1	<b>Administrative Boundary / other separation / known / definite (line)</b>	Geopolitical Line Type [LSP] = (Armistice Line [3], Cease Fire Line [7], Claim Line [9], Convention Line [8], Demarcation Line [5], Intercolonial Line [10], Interentity Line [11], Line of Adjacency [12], Line of Control [4], Line of Convenience [6], Line of Withdrawal [13], Military Disengagement Line [14], Provisional Administrative Line [2], Treaty Line [15], UNCLOS Claim Boundary [16])
	AND	Boundary Status [BST] = (Definite [1], Other [999], Unknown [0])
	Label String:	[Name1 (first side)] [Geopolitical Line Type] [Name2 (second side)]
	Characteristics:	48, 48 48 48 (Black, Condensed, Bold, 10 pt, Upper case)
PL-04001_2	<b>Administrative Boundary / other separation / known / indefinite, in dispute (line)</b>	Geopolitical Line Type [LSP] = (Armistice Line [3], Cease Fire Line [7], Claim Line [9], Convention Line [8], Demarcation Line [5], Intercolonial Line [10], Interentity Line [11], Line of Adjacency [12], Line of Control [4], Line of Convenience [6], Line of Withdrawal [13], Military Disengagement Line [14], Provisional Administrative Line [2], Treaty Line [15], UNCLOS Claim Boundary [16])
	AND	Boundary Status [BST] = (Indefinite [2], In Dispute [3])
	Label String:	[Name1 (first side)] [Geopolitical Line Type] "["[Boundary Status]"
		[Name2 (second side)]
	Characteristics:	48, 48, 48, 48, 48 48 48 (Black, Condensed, Bold, 10 pt, Upper case)
PL-04001_3	<b>Administrative Boundary / other separation / unknown / definite (line)</b>	Geopolitical Line Type [LSP] = (Generic Administrative Boundary [1], Other [999], Unknown [0])

AND Boundary Status [BST] = (Definite [1], Other [999], Unknown [0])

Label String: [Name1 (first side)] "Administrative Boundary"  
[Name2 (second side)]

Characteristics: 48, 48  
48  
48 (Black, Condensed, Bold, 10 pt, Upper case)

**PL-04001\_4 Administrative Boundary / other separation / unknown / indefinite, in dispute (line)** Geopolitical Line Type [LSP] = (Generic Administrative Boundary [1], Other [999], Unknown [0])

AND Boundary Status [BST] = (Indefinite [2], In Dispute [3])

Label String: [Name1 (first side)] "Administrative Boundary" "["[Boundary Status]""]  
[Name2 (second side)]

Characteristics: 48, 48, 48, 48, 48  
48  
48 (Black, Condensed, Bold, 10 pt, Upper case)

Symbol Samples

**LEBANON DEMARCATION LINE**  
-----  
**ISRAEL**

**LEBANON (IN DISPUTE)**  
-----  
**ISRAEL**

**Administrative Boundary / no defined boundary (line)**

Symbol Placement Instructions: Text label only. No graphic parameters

Symbol Type: Simple

NO DEFINED BOUNDARY

Symbol Graphic

Symbol Rules

Reference #:	Description:	Criteria:
<b>PS-04450</b>	<b>Administrative Boundary / no defined boundary (line)</b>	Boundary Status [BST] = No Defined Boundary [4]

Label Rules

Label Placement Rules (see Annex J): LP-9994, LP-9999

Reference #:	Description:	Criteria:
<b>PL-04450_1</b>	<b>Administrative Boundary / no defined boundary (line)</b>	N/A

Label String: [Name1 (first side)]  
"NO DEFINED BOUNDARY"  
[Name2 (second side)]

Characteristics: 21  
21  
21  
21 (Black, Condensed, 8 pt, Upper case)

Symbol Samples

PAKISTAN  
NO DEFINED BOUNDARY  
INDIA

**Administrative Division (FA003)**

Generalization Rules (see Annex J): GA-9999

## Administrative Division / first-order (area)



Symbol Graphic

**Symbol Placement Instructions:** The symbol is applied to the geometry of the feature.

**Symbol Type:** Complex

**Note:** Repeating pattern is Component L00133 followed by Component P00082 centered within each gap. The space between each element is 1.5 mm. Component L00444 is centered on Component L00133.

<b>Component Ref #:</b>	L00133	<b>Component Type:</b>	Line - Styled	<b>Color Token:</b>	Black
<b>Description:</b>	Black 0.3mm Dashed Line (0.3mm wt, 7.0mm dash, 3.4mm gap)				
<b>Parameters:</b>					
<b>Line Weight:</b>	0.3mm	<b>Dash Length:</b>	7.0mm	<b>Dash Spacing:</b>	3.4mm
<b>Component Ref #:</b>	L00444	<b>Component Type:</b>	Line - Simple	<b>Color Token:</b>	Dk-Brown1815-42
<b>Description:</b>	Dk-Brown1815-42 1.0mm Screened Line				
<b>Parameters:</b>					
<b>Line Weight:</b>	1.0mm				
<b>Screen Angle:</b>	60 degrees				
<b>Screen Percent:</b>	42%				
<b>Component Ref #:</b>	P00082	<b>Component Type:</b>	Point - Simple	<b>Color Token:</b>	Black
<b>Description:</b>	Black 0.4mm diameter filled circle				
<b>Parameters:</b>					
<b>Diameter:</b>	0.4mm				
<b>Note:</b>	The component is a circle and is filled with the solid color.				

### Symbol Rules

<b>Reference #:</b>	<b>Description:</b>	<b>Criteria:</b>
PS-04005	Administrative Division / first-order (area)	BGN Administrative Level [BAL] = First-order [1]

### Label Rules

<b>Label Placement Rules (see Annex J):</b> LP-9996, LP-9999		
<b>Reference #:</b>	<b>Description:</b>	<b>Criteria:</b>
PL-04005_1	Administrative Division / first-order (area)	N/A
<b>Label String:</b>	[Name]	
<b>Characteristics:</b>	21 21 (Black, Condensed, 8 pt, Upper case)	

### Symbol Samples



## Administrative Division / second-order (area)

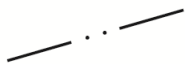

Symbol Graphic

**Symbol Placement Instructions:** The symbol is applied to the geometry of the feature.

**Symbol Type:** Complex

**Note:** Repeating pattern is Component L00448 followed by two Component P00082 centered within each gap. The space between each element is 1.5 mm.

<b>Component Ref #:</b>	L00448	<b>Component Type:</b>	Line - Styled	<b>Color Token:</b>	Black
<b>Description:</b>	Black 0.3mm Dashed Line (0.3mm wt, 7.0mm dash, 5.3mm gap)				
<b>Parameters:</b>					
<b>Line Weight:</b>	0.3mm	<b>Dash Length:</b>	7.0mm	<b>Dash Spacing:</b>	5.3mm

Component Ref #: P00082      Component Type: Point - Simple      Color Token: Black  
 Description: Black 0.4mm diameter filled circle  
Parameters:  
 Diameter: 0.4mm  
 Note: The component is a circle and is filled with the solid color.

**Symbol Rules**

Reference #: Description: Criteria:  
**PS-04006** Administrative Division / second-order (area) BGN Administrative Level [BAL] = Second-order [2]

**Label Rules**

Label Placement Rules (see Annex J): LP-9996, LP-9999

Reference #: Description: Criteria:  
**PL-04006\_1** Administrative Division / second-order (area) N/A

Label String: [Name]  
 Characteristics: 21  
 21 (Black, Condensed, 8 pt, Upper case)

**Symbol Samples**



**Administrative Division / other (area)**

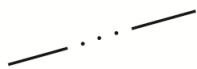

Symbol Graphic

Symbol Placement Instructions: The symbol is applied to the geometry of the feature.

Symbol Type: Complex

Note: Repeating pattern is Component L00449 followed by three Component P00082 centered within each gap. The space between each element is 1.5 mm.

Component Ref #: L00449      Component Type: Line - Styled      Color Token: Black  
 Description: Black 0.3mm Dashed Line (0.3mm wt, 7.0mm dash, 7.2mm gap)  
Parameters:  
 Line Weight: 0.3mm      Dash Length: 7.0mm      Dash Spacing: 7.2mm

Component Ref #: P00082      Component Type: Point - Simple      Color Token: Black  
 Description: Black 0.4mm diameter filled circle  
Parameters:  
 Diameter: 0.4mm  
 Note: The component is a circle and is filled with the solid color.

**Symbol Rules**

Reference #: Description: Criteria:  
**PS-04007** Administrative Division / other (area) BGN Administrative Level [BAL] = (Fourth-order [4], Other [999], Third-order [3], Undifferentiated [5], Unknown [0])

**Label Rules**

Label Placement Rules (see Annex J): LP-9996, LP-9999

Reference #: Description: Criteria:  
**PL-04007\_1** Administrative Division / other (area) N/A

Label String: [Name]  
 Characteristics: 21  
 21 (Black, Condensed, 8 pt, Upper case)

**Symbol Samples**

## Aeronautical Obstacle (GB220)

### Aeronautical Obstacle / single (point)



Symbol Graphic

Symbol Placement Instructions: Origin: Center of dot

Symbol Type: Simple

Note: If the symbol is moved away from the associated dot element, a Leader Line/aero blue is added connecting the symbol and the dot.

Component Ref #:	P00008	Component Type:	Point - Shape	Color Token:	Blue072
Description:	Vertical obstruction				
Parameters:					
Note:	See Annex H for detailed drawing instructions.				

### Symbol Rules

Reference #:	Description:	Criteria:
PS-04516	Aeronautical Obstacle / single (point)	Height Above Surface Level [HGT] >= 46

### Label Rules

Label Placement Rules (see Annex J): LP-9992

Reference #:	Description:	Criteria:
PL-04516_1	Aeronautical Obstacle / single / onshore (point)	Structures that are located onshore

Label String:	[Feature Name] [Highest Elevation] "("[Height Above Surface Level]")"
Characteristics:	15 46 95, 95, 95 15 (Blue072, Condensed, 6 pt, Mixed case) 46 (Blue072, Condensed, Bold, 6 pt, Lower case) 95 (Blue072, Condensed, 6 pt, Lower case)

Reference #:	Description:	Criteria:
PL-04516_2	Aeronautical Obstacle / single / offshore (point)	Structures that are located offshore

Label String:	[Feature Name] "("[Height Above Surface Level]")"
Characteristics:	15 95, 95, 95 15 (Blue072, Condensed, 6 pt, Mixed case) 95 (Blue072, Condensed, 6 pt, Lower case)

### Symbol Samples



### Aeronautical Obstacle / multiple (point)



Symbol Graphic

Symbol Placement Instructions: Origin: Center of dot

Symbol Type: Simple

Note: If the symbol is moved away from the associated dot element, a Leader Line/aero blue is added connecting the symbol and the dot.

Component Ref #:	P00101	Component Type:	Point - Shape	Color Token:	Blue072
Description:	Vertical obstruction multiple				
<a href="#">Parameters:</a>					
Note:	See Annex H for detailed drawing instructions.				

### Symbol Rules

Reference #:	Description:	Criteria:
PS-04517	<b>Aeronautical Obstacle / multiple (point)</b>	Use this symbol to replace a group of single vertical obstruction symbols as needed.

### Label Rules

Label Placement Rules (see Annex J): LP-9992

Reference #:	Description:	Criteria:
PL-04517_1	<b>Aeronautical Obstacle / multiple / onshore / same (point)</b>	Same structures that are located onshore
	<p>Label String: [Feature Name]"s" [Highest Elevation] "("[Height Above Surface Level]")"</p> <p>Characteristics: 15, 95 46 95, 95, 95 15 (Blue072, Condensed, 6 pt, Mixed case) 46 (Blue072, Condensed, Bold, 6 pt, Lower case) 95 (Blue072, Condensed, 6 pt, Lower case) 95 (Blue072, Condensed, 6 pt, Lower case)</p>	
PL-04517_2	<b>Aeronautical Obstacle / multiple / onshore / different (point)</b>	Different structures that are located onshore
	<p>Label String: [Highest Elevation] "("[Height Above Surface Level]")"</p> <p>Characteristics: 46 95, 95, 95 46 (Blue072, Condensed, Bold, 6 pt, Lower case) 95 (Blue072, Condensed, 6 pt, Lower case)</p>	
PL-04517_3	<b>Aeronautical Obstacle / multiple / offshore / same (point)</b>	Structures that are located offshore
	<p>Label String: [Feature Name] "("[Height Above Surface Level]")"</p> <p>Characteristics: 15 95, 95, 95 15 (Blue072, Condensed, 6 pt, Mixed case) 95 (Blue072, Condensed, 6 pt, Lower case)</p>	
PL-04517_4	<b>Aeronautical Obstacle / multiple / offshore / different (point)</b>	Different structures that are located offshore
	<p>Label String: "("[Height Above Surface Level]")"</p> <p>Characteristics: 95, 95, 95 95 (Blue072, Condensed, 6 pt, Lower case)</p>	

### Symbol Samples



## Aeronautical Radio Navigation Service (GA034)

## Aeronautical Radio Navigation Service / all (point)



Symbol Graphic

Symbol Placement Instructions: Origin: Center of symbol

Symbol Type: Simple

Component Ref #: P00294      Component Type: Point - Shape      Color Token: Blue072  
 Description: Radio aid  
[Parameters:](#)  
 Note: See Annex H for detailed drawing instructions.

### Symbol Rules

Reference #:	Description:	Criteria:
<b>PS-04675</b>	<b>Aeronautical Radio Navigation Service / all (point)</b>	All

### Label Rules

Label Placement Rules (see Annex J): LP-3505

Reference #:	Description:	Criteria:
<b>PL-04675_1</b>	<b>Aeronautical Radio Navigation Service / all (point)</b>	N/A

Label String: "Radio aid"  
 Characteristics: 15  
 15 (Blue072, Condensed, 6 pt, Mixed case)

### Symbol Samples



## Aircraft Hangar (GB230)

Generalization Rules (see Annex J): GA-9999, GC-9993, GC-9994

## Aircraft Hangar / intact (area)



Symbol Graphic

Symbol Placement Instructions: The symbol is applied to the geometry of the feature.

Symbol Type: Simple

Component Ref #: A00006      Component Type: Area - Fill      Color Token: Black  
 Description: Black solid fill  
[Parameters:](#)  
 Note: The surface geometry is filled with the solid color.

### Symbol Rules

Reference #:	Description:	Criteria:
<b>PS-04456</b>	<b>Aircraft Hangar / intact (area)</b>	Condition of Facility [FUN] = (Fully Functional [6], Unknown [0])

### Label Rules

Label Placement Rules (see Annex J): LP-3505

Reference #:	Description:	Criteria:
<b>PL-04456_1</b>	<b>Aircraft Hangar / intact (area)</b>	N/A

Label String: "Hangar"  
 Characteristics: 1

1 (Black, Condensed, 6 pt, Mixed case)

Symbol Samples



Hangar

**Aircraft Hangar / not intact (area)**



Symbol Graphic

Symbol Placement Instructions: The symbol is applied to the geometry of the feature.

Symbol Type: Complex

Note: Component L00007 is applied to the perimeter and is filled with Component A00064.

Component Ref #:	A00064	Component Type:	Area - Fill	Color Token:	Black-12
Description:	Black-12 area fill				
Parameters:					
Screen Angle:	45 degrees				
Screen Percent:	12%				

Component Ref #:	L00007	Component Type:	Line - Simple	Color Token:	Black
Description:	Black 0.1mm Solid Line				
Parameters:					
Line Weight:	0.1mm				

Symbol Rules

Reference #:	Description:	Criteria:
PS-04039	Aircraft Hangar / not intact (area)	Condition of Facility [FUN] = (Abandoned [2], Damaged [13], Destroyed [3], Dismantled [4], Under Construction [1])

Symbol Samples



**Aircraft Hangar / intact (point)**



Symbol Graphic

Symbol Placement Instructions: Origin: Center of symbol

Symbol Type: Simple

Component Ref #:	P00006	Component Type:	Point - Simple	Color Token:	Black
Description:	Black filled square with all sides 0.8mm				
Parameters:					
Length:	0.8mm				
Note:	The component is a square and is filled with the solid color.				

Symbol Rules

Reference #:	Description:	Criteria:
PS-04455	Aircraft Hangar / intact (point)	Condition of Facility [FUN] = (Fully Functional [6], Unknown [0])

Label Rules



Label Placement Rules (see Annex J): LP-3505

Reference #:	Description:	Criteria:
<b>PL-04455_1</b>	<b>Aircraft Hangar / intact (point)</b>	N/A

Label String: "Hangar"  
 Characteristics: 1  
 1 (Black, Condensed, 6 pt, Mixed case)

Symbol Samples

■ Hangar

**Aircraft Hangar / not intact (point)**

Symbol Placement Instructions: Origin: Center of symbol  
 Symbol Type: Simple



Symbol Graphic

Component Ref #:	P00293	Component Type:	Point - Shape	Color Token:	Black/Black-12
Description:	Not intact square 0.6mm				
Parameters:					
Note:	See Annex H for detailed drawing instructions.				

Symbol Rules

Reference #:	Description:	Criteria:
<b>PS-04040</b>	<b>Aircraft Hangar / not intact (point)</b>	Condition of Facility [FUN] = (Abandoned [2], Damaged [13], Destroyed [3], Dismantled [4], Under Construction [1])

Symbol Samples

□

**Aircraft Revetment (GB050)**

Generalization Rules (see Annex J): GA-9999

**Aircraft Revetment / all (line)**

Symbol Placement Instructions: The symbol is applied to the geometry of the feature.  
 Symbol Type: Complex  
 Repeating Point and Interval: Component P00174 has an initial offset of 0.75mm; after that 1.5mm.



Symbol Graphic

Note: Component P00174 is attached perpendicular to Component L00240 and point outward.

Component Ref #:	L00240	Component Type:	Line - Simple	Color Token:	Dk-Brown1815
Description:	Dk-Brown1815 0.15mm Solid Line				
Parameters:					
Line Weight:	0.15mm				

Component Ref #: P00174      Component Type: Point - Simple      Color Token: Dk-Brown1815  
 Description: Dk-Brown1815 0.5mm length line with 0.15mm lineweight  
Parameters:  
 Line Weight: 0.15mm  
 Length: 0.5mm

Symbol Rules

Reference #: Description: Criteria:  
**PS-04008** Aircraft Revetment / all (line) All

Symbol Samples



**Aircraft Revetment / all (point)**

Symbol Placement Instructions: Origin: Center of symbol  
 Symbol Type: Simple



Symbol Graphic

Component Ref #: P00295      Component Type: Point - Shape      Color Token: Dk-Brown1815  
 Description: Aircraft revetment  
Parameters:  
 Note: See Annex H for detailed drawing instructions.

Symbol Rules

Reference #: Description: Criteria:  
**PS-04037** Aircraft Revetment / all (point) All

Symbol Samples



**Amusement Park (AK030)**

Generalization Rules (see Annex J): GA-9999, GC-9999

**Amusement Park / all (area)**

Symbol Placement Instructions: The symbol is applied to the geometry of the feature.  
 Symbol Type: Simple

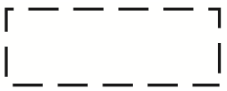

Symbol Graphic

Component Ref #: L00210      Component Type: Line - Styled      Color Token: Black  
 Description: Black 0.1mm Dashed line (0.1mm wt, 1.0mm dash, 0.5mm gap)  
Parameters:  
 Line Weight: 0.1mm      Dash Length: 1.0mm      Dash Spacing: 0.5mm

Symbol Rules

Reference #: **PS-04009** Description: **Amusement Park / all (area)** Criteria: All

Label Rules

Label Placement Rules (see Annex J): LP-3506, LP-4813, LP-9950, LP-9999

Reference #: **PL-04009\_1** Description: **Amusement Park / intact (area)** Criteria: Condition of Facility [FUN] = (Fully Functional [6], Unknown [0])

Label String: [Name] "Amusement park"  
 Characteristics: 1, 1  
 1 (Black, Condensed, 6 pt, Mixed case)

Reference #: **PL-04009\_2** Description: **Amusement Park / not intact (area)** Criteria: Condition of Facility [FUN] = (Abandoned [2], Damaged [13], Destroyed [3], Dismantled [4], Under Construction [1])

Label String: [Name] "Amusement park" ("[Condition of Facility]")  
 Characteristics: 1, 1, 22, 22, 22  
 1 (Black, Condensed, 6 pt, Mixed case)  
 22 (Black, Condensed, 6 pt, Lower case)

Symbol Samples

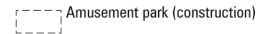
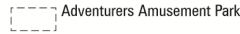
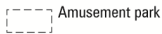

Amusement Park / intact (point)



Symbol Graphic

Symbol Placement Instructions: Origin: Center of symbol  
 Symbol Type: Simple

Component Ref #: P00006 Component Type: Point - Simple Color Token: Black  
 Description: Black filled square with all sides 0.8mm  
 Parameters:  
 Length: 0.8mm  
 Note: The component is a square and is filled with the solid color.

Symbol Rules

Reference #: **PS-04459** Description: **Amusement Park / intact (point)** Criteria: Condition of Facility [FUN] = (Fully Functional [6], Unknown [0])

Label Rules

Label Placement Rules (see Annex J): LP-3505, LP-4813, LP-9999

Reference #: **PL-04459\_1** Description: **Amusement Park / intact (point)** Criteria: N/A

Label String: [Name] "Amusement park"  
 Characteristics: 1, 1  
 1 (Black, Condensed, 6 pt, Mixed case)

Symbol Samples

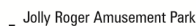
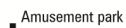

## Amusement Park / not intact (point)

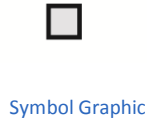

Symbol Placement Instructions: Origin: Center of symbol  
 Symbol Type: Simple

Component Ref #: P00173      Component Type: Point - Shape      Color Token: Black/Black-12  
 Description: Not intact square 0.8mm  
[Parameters:](#)  
 Note: See Annex H for detailed drawing instructions.

### Symbol Rules

Reference #:	Description:	Criteria:
<b>PS-04883</b>	<b>Amusement Park / not intact (point)</b>	Condition of Facility [FUN] = (Abandoned [2], Damaged [13], Destroyed [3], Dismantled [4], Under Construction [1])

### Label Rules

Label Placement Rules (see Annex J): LP-3505

Reference #:	Description:	Criteria:
<b>PL-04883_1</b>	<b>Amusement Park / not intact (point)</b>	N/A

Label String: "Amusement park"  
 Characteristics: 1  
 1 (Black, Condensed, 6 pt, Mixed case)

### Symbol Samples

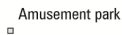

## Approach Lighting System (GB485)

### Approach Lighting System / all (point)

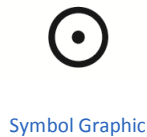

Symbol Placement Instructions: Origin: Center of symbol  
 Symbol Type: Simple

Component Ref #: P00010      Component Type: Point - Shape      Color Token: Black  
 Description: Located object  
[Parameters:](#)  
 Note: See Annex H for detailed drawing instructions.

### Symbol Rules

Reference #:	Description:	Criteria:
<b>PS-04674</b>	<b>Approach Lighting System / all (point)</b>	All

### Label Rules

Label Placement Rules (see Annex J): LP-3505

Reference #:	Description:	Criteria:
<b>PL-04674_1</b>	<b>Approach Lighting System / all (point)</b>	N/A

Label String: "Approach lighting system"  
 Characteristics: 1

Symbol Samples

⊙ Approach lighting system

**Apron (GB015)**

Generalization Rules (see Annex J): GA-9999, GC-9994

**Apron / all (area)**



Symbol Graphic

Symbol Placement Instructions: The symbol is applied to the geometry of the feature.

Symbol Type: Complex

Note: Component L00217 is applied to the perimeter and is filled with Component A00125.

Component Ref #:	A00125	Component Type:	Area - Fill	Color Token:	Blue072-12
Description:	Blue072-12 area fill				
Parameters:					
Screen Angle:	45 degrees				
Screen Percent:	12%				

Component Ref #:	L00217	Component Type:	Line - Simple	Color Token:	Blue072
Description:	Blue072 0.1mm Solid Line				
Parameters:					
Line Weight:	0.1mm				

Symbol Rules

Reference #:	Description:	Criteria:
PS-04010	Apron / all (area)	All

Symbol Samples



**Aqueduct (BH010)**

Generalization Rules (see Annex J): GA-9999

**Aqueduct / intact (area)**



Symbol Graphic

Symbol Placement Instructions: The symbol is applied to the geometry of the feature.

Symbol Type: Complex

Note: Component L00015 is applied to the perimeter and is filled with Component A00007.

Component Ref #:	A00007	Component Type:	Area - Fill	Color Token:	Cyan-31
Description:	Cyan-31 area fill				
Parameters:					
Screen Angle:	45 degrees				
Screen Percent:	31%				

Component Ref #: L00015      Component Type: Line - Simple      Color Token: Cyan  
 Description: Cyan 0.2mm Solid Line  
Parameters:  
 Line Weight: 0.2mm

**Symbol Rules**

Reference #: Description: Criteria:  
**PS-04461** **Aqueduct / intact (area)** Condition of Facility [FUN] = (Fully Functional [6], Unknown [0])

**Label Rules**

Label Placement Rules (see Annex J): LP-0062, LP-4813, LP-9997, LP-9999

Reference #: Description: Criteria:  
**PL-04461\_1** **Aqueduct / intact / on ground (area)** Vertical Relative Location [LOC] = (On Surface [44], Unknown [0])

Label String: [Name] "AQUEDUCT"  
 Characteristics: 37, 37  
 37 (Cyan, Condensed, Italic, 7-16 pt, Upper case)

**PL-04461\_2** **Aqueduct / intact / elevated (area)** Vertical Relative Location [LOC] = Above Surface [45]

Label String: [Name] "AQUEDUCT" "(ELEVATED)"  
 Characteristics: 37, 37, 37  
 37 (Cyan, Condensed, Italic, 7-16 pt, Upper case)

**PL-04461\_3** **Aqueduct / intact / underground (area)** Vertical Relative Location [LOC] = Below Ground Surface [40]

Label String: [Name] "AQUEDUCT" "(UNDERGROUND)"  
 Characteristics: 37, 37, 37  
 37 (Cyan, Condensed, Italic, 7-16 pt, Upper case)

**Symbol Samples**

*AQUEDUCT*

*CATSKILL AQUEDUCT*

*AQUEDUCT (UNDERGROUND)*

**Aqueduct / not intact (area)**



Symbol Graphic

Symbol Placement Instructions: The symbol is applied to the geometry of the feature.  
 Symbol Type: Simple

Component Ref #: L00041      Component Type: Line - Styled      Color Token: Cyan  
 Description: Cyan 0.2mm Dashed Line (0.2mm wt, 2.0mm dash, 0.5mm gap)  
Parameters:  
 Line Weight: 0.2mm      Dash Length: 2.0mm      Dash Spacing: 0.5mm

**Symbol Rules**

Reference #: Description: Criteria:  
**PS-04462** **Aqueduct / not intact (area)** Condition of Facility [FUN] = (Abandoned [2], Damaged [13], Destroyed [3], Dismantled [4], Under Construction [1])

**Label Rules**

Label Placement Rules (see Annex J): LP-0062, LP-4813, LP-9950, LP-9997, LP-9999

Reference #: Description: Criteria:  
**PL-04462\_1** **Aqueduct / not intact / on ground (area)** Vertical Relative Location [LOC] = (On Surface [44], Unknown [0])

Label String: [Name] "AQUEDUCT" "("[Condition of Facility]"")"  
 Characteristics: 37, 37, 37, 37, 37  
 37 (Cyan, Condensed, Italic, 7-16 pt, Upper case)

**PL-04462\_2** **Aqueduct / not intact / elevated (area)** Vertical Relative Location [LOC] = Above Surface [45]

**Label String:** [Name] "AQUEDUCT" "(ELEVATED)" "("[Condition of Facility]"")"  
**Characteristics:** 37, 37, 37, 37, 37, 37  
 37 (Cyan, Condensed, Italic, 7-16 pt, Upper case)

**PL-04462\_3** **Aqueduct / not intact / underground (area)** Vertical Relative Location [LOC] = Below Ground Surface [40]

**Label String:** [Name] "AQUEDUCT" "(UNDERGROUND)" "("[Condition of Facility]"")"  
**Characteristics:** 37, 37, 37, 37, 37, 37  
 37 (Cyan, Condensed, Italic, 7-16 pt, Upper case)

**Symbol Samples**



**Aqueduct / on ground (line)**



Symbol Graphic

**Symbol Placement Instructions:** The symbol is applied to the geometry of the feature.

**Symbol Type:** Simple

**Component Ref #:** L00016      **Component Type:** Line - Simple      **Color Token:** Cyan  
**Description:** Cyan 0.3mm Solid Line  
**Parameters:**  
**Line Weight:** 0.3mm

**Symbol Rules**

**Reference #:** **Description:**      **Criteria:**  
**PS-04011** **Aqueduct / on ground (line)**      Vertical Relative Location [LOC] = (On Surface [44], Unknown [0])

**Label Rules**

**Label Placement Rules (see Annex J):** LP-3630, LP-4813, LP-9950, LP-9999

**Reference #:** **Description:**      **Criteria:**  
**PL-04011\_1** **Aqueduct / on ground / intact (line)**      Condition of Facility [FUN] = (Fully Functional [6], Unknown [0])

**Label String:** [Name] "Aqueduct"  
**Characteristics:** 16, 16  
 16 (Cyan, Condensed, Italic, 6 pt, Mixed case)

**PL-04011\_2** **Aqueduct / on ground / not intact (line)**      Condition of Facility [FUN] = (Abandoned [2], Damaged [13], Destroyed [3], Dismantled [4], Under Construction [1])

**Label String:** [Name] "Aqueduct" "("[Condition of Facility]"")"  
**Characteristics:** 16, 16, 23, 23, 23  
 16 (Cyan, Condensed, Italic, 6 pt, Mixed case)  
 23 (Cyan, Condensed, Italic, 6 pt, Lower case)

**Symbol Samples**



**Aqueduct / elevated (line)**



Symbol Graphic

**Symbol Placement Instructions:** The symbol is applied to the geometry of the feature.

**Symbol Type:** Complex

**Note:** Apex of Component P00208 is fixed at the start and end of Component L00016 with each "V" facing away. The 90 degree angle of the "V" is bisected equally by the line component.

<b>Component Ref #:</b> L00016	<b>Component Type:</b> Line - Simple	<b>Color Token:</b> Cyan
<b>Description:</b> Cyan 0.3mm Solid Line		
<u>Parameters:</u>		
<b>Line Weight:</b> 0.3mm		

---

<b>Component Ref #:</b> P00208	<b>Component Type:</b> Point - Shape	<b>Color Token:</b> Cyan
<b>Description:</b> Aqueduct/penstock/water race "V"		
<u>Parameters:</u>		
<b>Note:</b> See Annex H for detailed drawing instructions.		

### Symbol Rules

<b>Reference #:</b>	<b>Description:</b>	<b>Criteria:</b>
<b>PS-04012</b>	<b>Aqueduct / elevated (line)</b>	Vertical Relative Location [LOC] = Above Surface [45]

### Label Rules

<b>Label Placement Rules (see Annex J):</b> LP-3630, LP-4813, LP-9950, LP-9999		
<b>Reference #:</b>	<b>Description:</b>	<b>Criteria:</b>
<b>PL-04012_1</b>	<b>Aqueduct / elevated / intact (line)</b>	Condition of Facility [FUN] = (Fully Functional [6], Unknown [0])
	<b>Label String:</b> [Name] "Aqueduct"	
	<b>Characteristics:</b> 16, 16 16 (Cyan, Condensed, Italic, 6 pt, Mixed case)	
<b>PL-04012_2</b>	<b>Aqueduct / elevated / not intact (line)</b>	Condition of Facility [FUN] = (Abandoned [2], Damaged [13], Destroyed [3], Dismantled [4], Under Construction [1])
	<b>Label String:</b> [Name] "Aqueduct" ("["Condition of Facility]")"	
	<b>Characteristics:</b> 16, 16, 23, 23, 23 16 (Cyan, Condensed, Italic, 6 pt, Mixed case) 23 (Cyan, Condensed, Italic, 6 pt, Lower case)	

### Symbol Samples



## Aqueduct / underground / without qanat shafts (line)



Symbol Graphic

**Symbol Placement Instructions:** The symbol is applied to the geometry of the feature.

**Symbol Type:** Simple

<b>Component Ref #:</b> L00235	<b>Component Type:</b> Line - Styled	<b>Color Token:</b> Cyan
<b>Description:</b> Cyan 0.3mm Dashed Line (0.3mm wt, 1.0mm dash, 0.5mm gap)		
<u>Parameters:</u>		
<b>Line Weight:</b> 0.3mm	<b>Dash Length:</b> 1.0mm	<b>Dash Spacing:</b> 0.5mm

### Symbol Rules

<b>Reference #:</b>	<b>Description:</b>	<b>Criteria:</b>
<b>PS-04013</b>	<b>Aqueduct / underground / without qanat shafts (line)</b>	Vertical Relative Location [LOC] = Below Ground Surface [40]
	AND	Not associated with qanat shafts



**Label Rules**

Label Placement Rules (see Annex J): LP-3630, LP-4813, LP-9950, LP-9999

<b>Reference #:</b>	<b>Description:</b>	<b>Criteria:</b>
<b>PL-04013_1</b>	<b>Aqueduct / underground / without qanat shafts / intact (line)</b>	Condition of Facility [FUN] = (Fully Functional [6], Unknown [0])
	Label String: [Name] "Aqueduct"	
	Characteristics: 16, 16 16 (Cyan, Condensed, Italic, 6 pt, Mixed case)	
<b>PL-04013_2</b>	<b>Aqueduct / underground / without qanat shafts / not intact (line)</b>	Condition of Facility [FUN] = (Abandoned [2], Damaged [13], Destroyed [3], Dismantled [4], Under Construction [1])
	Label String: [Name] "Aqueduct" ("[Condition of Facility]")	
	Characteristics: 16, 16, 23, 23, 23 16 (Cyan, Condensed, Italic, 6 pt, Mixed case) 23 (Cyan, Condensed, Italic, 6 pt, Lower case)	

**Symbol Samples**



**Aqueduct / underground / with qanat shafts (line)**

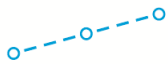

Symbol Graphic

**Symbol Placement Instructions:** The symbol is applied to the geometry of the feature.  
**Symbol Type:** Complex  
**Repeating Point and Interval:** Component P00040 has an initial offset of 3.0mm; after that 6.0mm (center to center).  
**Note:** Component P00040 is centered along Component L00040. If a linear aqueduct is not extracted, the symbol shall be applied to a line connecting the extracted point aqueducts (qanat shafts). Individual qanat shafts associated with this feature are not symbolized.

<b>Component Ref #:</b>	L00040	<b>Component Type:</b>	Line - Styled	<b>Color Token:</b>	Cyan
<b>Description:</b>	Cyan 0.2mm Dashed Line (0.2mm wt, 1.0mm dash, 0.5mm gap)				
<b>Parameters:</b>					
<b>Line Weight:</b>	0.2mm	<b>Dash Length:</b>	1.0mm	<b>Dash Spacing:</b>	0.5mm
<b>Component Ref #:</b>	P00040	<b>Component Type:</b>	Point - Simple	<b>Color Token:</b>	Cyan
<b>Description:</b>	Qanat/Water well intermittent				
<b>Parameters:</b>					
<b>Diameter:</b>	1.0mm				
<b>Line Weight:</b>	0.15mm				
<b>Note:</b>	The component is an open circle.				

**Symbol Rules**

<b>Reference #:</b>	<b>Description:</b>	<b>Criteria:</b>
<b>PS-04463</b>	<b>Aqueduct / underground / with qanat shafts (line)</b>	Vertical Relative Location [LOC] = Below Ground Surface [40]
	AND Associated with qanat shafts	

**Label Rules**

Label Placement Rules (see Annex J): LP-3630, LP-9999

<b>Reference #:</b>	<b>Description:</b>	<b>Criteria:</b>
<b>PS-04463_1</b>	<b>Aqueduct / underground / with qanat shafts (line)</b>	N/A
	Label String: [Name]	
	Characteristics: 16 16 (Cyan, Condensed, Italic, 6 pt, Mixed case)	

**Symbol Samples**



## Aqueduct / all (point)



Symbol Graphic

**Symbol Placement Instructions:** The symbol is applied to the geometry of the feature.

**Symbol Type:** Simple

**Note:** Aqueduct / point is the symbol used for an individual qanat or karez shaft. Multiple qanat shafts associated with an linear underground aqueduct are not symbolized.

<b>Component Ref #:</b>	P00040	<b>Component Type:</b>	Point - Simple	<b>Color Token:</b>	Cyan
<b>Description:</b>	Qanat/Water well intermittent				
<b>Parameters:</b>					
<b>Diameter:</b>	1.0mm				
<b>Line Weight:</b>	0.15mm				
<b>Note:</b>	The component is an open circle.				

### Symbol Rules

<b>Reference #:</b>	<b>Description:</b>	<b>Criteria:</b>
PS-04242	Aqueduct / all (point)	All

### Symbol Samples



## Archeological Site (AL012)

Generalization Rules (see Annex J): GA-9999

## Archeological Site / all (area)

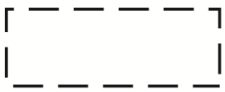

Symbol Graphic

**Symbol Placement Instructions:** The symbol is applied to the geometry of the feature.

**Symbol Type:** Simple

<b>Component Ref #:</b>	L00210	<b>Component Type:</b>	Line - Styled	<b>Color Token:</b>	Black
<b>Description:</b>	Black 0.1mm Dashed line (0.1mm wt, 1.0mm dash, 0.5mm gap)				
<b>Parameters:</b>					
<b>Line Weight:</b>	0.1mm	<b>Dash Length:</b>	1.0mm	<b>Dash Spacing:</b>	0.5mm

### Symbol Rules

<b>Reference #:</b>	<b>Description:</b>	<b>Criteria:</b>
PS-04017	Archeological Site / all (area)	All

### Label Rules

Label Placement Rules (see Annex J): LP-3506, LP-4813, LP-9999

<b>Reference #:</b>	<b>Description:</b>	<b>Criteria:</b>
PL-04017_1	Archeological Site / all (area)	N/A

Label String: [Name] "Archeological site"  
 Characteristics: 1, 1  
 1 (Black, Condensed, 6 pt, Mixed case)

Symbol Samples

Archeological site

Shawnee Minisink Archeological Site

Archeological Site / all (point)



Symbol Graphic

Symbol Placement Instructions: Origin: Center of symbol  
 Symbol Type: Simple

Component Ref #: P00010      Component Type: Point - Shape      Color Token: Black  
 Description: Located object  
 Parameters:  
 Note: See Annex H for detailed drawing instructions.

Symbol Rules

Reference #: PS-04018      Description: Archeological Site / all (point)      Criteria: All

Label Rules

Label Placement Rules (see Annex J): LP-3505, LP-4813, LP-9999

Reference #: PL-04018\_1      Description: Archeological Site / all (point)      Criteria: N/A

Label String: [Name] "Archeological site"  
 Characteristics: 1, 1  
 1 (Black, Condensed, 6 pt, Mixed case)

Symbol Samples

Archeological site

Roundtop Archeological Site

Beach (BA050)

Generalization Rules (see Annex J): GA-9999

Beach / pebble (area)



Symbol Graphic

Symbol Placement Instructions: The symbol is applied to the geometry of the feature.  
 Symbol Type: Simple

Component Ref #: A00036      Component Type: Area - Pattern      Color Token: Dk-Brown1815  
 Description: Dk-Brown1815 Gravel Fill  
 Parameters:  
 Area Pattern: AP-99, see Annex I

Symbol Rules

Reference #: **PS-04753** Description: **Beach / pebble (area)** Criteria: Surface Material Type [SMC] = Pebbles [73]

Label Rules

Label Placement Rules (see Annex J): LP-3506, LP-9999

Reference #: **PL-04753\_1** Description: **Beach / pebble (area)** Criteria: N/A

Label String: [Name]  
 Characteristics: 5  
 5 (Black, Condensed, Italic, 6 pt, Mixed case)

Symbol Samples

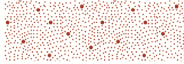

Beach / sand (area)



Symbol Graphic

Symbol Placement Instructions: The symbol is applied to the geometry of the feature.  
 Symbol Type: Simple

Component Ref #: A00035 Component Type: Area - Pattern Color Token: Dk-Brown1815  
 Description: Dk-Brown1815 Sand Fill  
 Parameters: Area Pattern: AP-95, see Annex I

Symbol Rules

Reference #: **PS-04754** Description: **Beach / sand (area)** Criteria: Surface Material Type [SMC] = (Other [999], Sand [88], Unknown [0])

Label Rules

Label Placement Rules (see Annex J): LP-3506, LP-9999

Reference #: **PL-04754\_1** Description: **Beach / sand (area)** Criteria: N/A

Label String: [Name]  
 Characteristics: 5  
 5 (Black, Condensed, Italic, 6 pt, Mixed case)

Symbol Samples



Beach / all (point)

[NAM]

Symbol Graphic

Symbol Placement Instructions: Text label only. No graphic parameters

Symbol Type: Simple

Symbol Rules

Reference #:	Description:	Criteria:
PS-04755	Beach / all (point)	All

Label Rules

Label Placement Rules (see Annex J): LP-3505, LP-9999

Reference #:	Description:	Criteria:
PL-04755_1	Beach / all (point)	N/A

Label String: [Name]  
 Characteristics: 5  
 5 (Black, Condensed, Italic, 6 pt, Mixed case)

Symbol Samples

*Red Beach*

**Berthing Structure (BB190)**

Generalization Rules (see Annex J): GA-9999

**Berthing Structure / dry (area)**



Symbol Graphic

Symbol Placement Instructions: The symbol is applied to the geometry of the feature.

Symbol Type: Simple

Note: This symbol is portrayed in conjunction with the Tidal Water symbol and shall mask out the Tidal Water symbol.

Component Ref #:	L00007	Component Type:	Line - Simple	Color Token:	Black
Description:	Black 0.1mm Solid Line				
Parameters:					
Line Weight:	0.1mm				

Symbol Rules

Reference #:	Description:	Criteria:
PS-04744	Berthing Structure / dry (area)	Water Level Effect [WLE] = Always Dry [2], Floating [8], Not Applicable [998], Other [999], Unknown [0]

Label Rules

Label Placement Rules (see Annex J): LP-3505, LP-9999

Reference #:	Description:	Criteria:
PL-04744_1	Berthing Structure / dry (area)	N/A

Label String: [Shoreline Construction Type]  
 Characteristics: 1  
 1 (Black, Condensed, 6 pt, Mixed case)

Symbol Samples

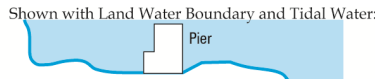

### Berthing Structure / not dry (area)



Symbol Graphic

**Symbol Placement Instructions:** The symbol is applied to the geometry of the feature.

**Symbol Type:** Complex

**Note:** The symbol is shown in conjunction with with Tidal Water symbol and shall not mask out the Tidal Water symbol.

<b>Component Ref #:</b>	A00048	<b>Component Type:</b>	Area - Fill	<b>Color Token:</b>	Black-12
<b>Description:</b>	Black-12 area fill				
<b>Parameters:</b>					
<b>Screen Angle:</b>	15 degrees				
<b>Screen Percent:</b>	12%				

<b>Component Ref #:</b>	L00210	<b>Component Type:</b>	Line - Styled	<b>Color Token:</b>	Black
<b>Description:</b>	Black 0.1mm Dashed line (0.1mm wt, 1.0mm dash, 0.5mm gap)				
<b>Parameters:</b>					
<b>Line Weight:</b>	0.1mm	<b>Dash Length:</b>	1.0mm	<b>Dash Spacing:</b>	0.5mm

#### Symbol Rules

<b>Reference #:</b>	<b>Description:</b>	<b>Criteria:</b>
PS-04745	Berthing Structure / not dry (area)	Water Level Effect [WLE] = (Always Submerged [3], Covers and Uncovers [4], Partly Submerged [1])

#### Label Rules

Label Placement Rules (see Annex J): LP-3505, LP-9999

<b>Reference #:</b>	<b>Description:</b>	<b>Criteria:</b>
PL-04745_1	Berthing Structure / not dry (area)	N/A

**Label String:** [Shoreline Construction Type]  
**Characteristics:** 1  
 1 (Black, Condensed, 6 pt, Mixed case)

#### Symbol Samples

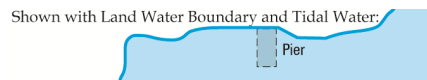

### Berthing Structure / dry (line)



Symbol Graphic

**Symbol Placement Instructions:** The symbol is applied to the geometry of the feature.

**Symbol Type:** Simple

<b>Component Ref #:</b>	L00009	<b>Component Type:</b>	Line - Simple	<b>Color Token:</b>	Black
<b>Description:</b>	Black 0.2mm Solid Line				
<b>Parameters:</b>					
<b>Line Weight:</b>	0.2mm				

**Symbol Rules**

Reference #: **PS-04746** Description: **Berthing Structure / dry (line)** Criteria: Water Level Effect [WLE] = Always Dry [2], Floating [8], Not Applicable [998], Other [999], Unknown [0]

**Label Rules**

Label Placement Rules (see Annex J): LP-3505, LP-9999

Reference #: **PL-04746\_1** Description: **Berthing Structure / dry (line)** Criteria: N/A

Label String: [Shoreline Construction Type]  
 Characteristics: 1  
 1 (Black, Condensed, 6 pt, Mixed case)

**Symbol Samples**



**Berthing Structure / not dry (line)**

Symbol Placement Instructions: The symbol is applied to the geometry of the feature.  
 Symbol Type: Simple

Component Ref #:	L00031	Component Type:	Line - Styled	Color Token:	Black
Description:	Black 0.2mm Dashed Line (0.2mm wt, 1.0mm dash, 0.5mm gap)				
Parameters:					
Line Weight:	0.2mm	Dash Length:	1.0mm	Dash Spacing:	0.5mm

**Symbol Rules**

Reference #: **PS-04747** Description: **Berthing Structure / not dry (line)** Criteria: Water Level Effect [WLE] = (Always Submerged [3], Covers and Uncovers [4], Partly Submerged [1])

**Label Rules**

Label Placement Rules (see Annex J): LP-3505, LP-9999

Reference #: **PL-04747\_1** Description: **Berthing Structure / not dry (line)** Criteria: N/A

Label String: [Shoreline Construction Type]  
 Characteristics: 1  
 1 (Black, Condensed, 6 pt, Mixed case)

**Symbol Samples**

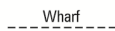

**Bog (BH015)**

Generalization Rules (see Annex J): GA-9999

**Bog / all (area)**



Symbol Graphic

Symbol Placement Instructions: The symbol is applied to the geometry of the feature.

Symbol Type: Complex

Note: Component P00167 is applied to the perimeter with a spacing of 0.8mm, center to center, and is filled with Component A00018.

Component Ref #:	A00018	Component Type:	Area - Pattern	Color Token:	Cyan
Description:	Cyan Bog, Marsh Fill				
Parameters:	<a href="#">Parameters:</a>				
Area Pattern:	AP-12, see Annex I				

Component Ref #:	P00167	Component Type:	Point - Simple	Color Token:	Cyan
Description:	Cyan 0.25mm diameter filled circle				
Parameters:	<a href="#">Parameters:</a>				
Diameter:	0.25mm				
Note:	The component is a circle and is filled with the solid color.				

Symbol Rules

Reference #:	Description:	Criteria:
PS-04021	Bog / all (area)	All

Label Rules

Label Placement Rules (see Annex J): LP-3506, LP-9999

Reference #:	Description:	Criteria:
PL-04021_1	Bog / all (area)	Bog Type [BOC] = (Cranberry Bog [7], Peat Bog [14])

Label String: [Bog Type]  
 Characteristics: 16  
 16 (Cyan, Condensed, Italic, 6 pt, Mixed case)

Symbol Samples



Breakwater (BB041)

Generalization Rules (see Annex J): GA-9999

Breakwater / dry (area)



Symbol Graphic

Symbol Placement Instructions: The symbol is applied to the geometry of the feature.

Symbol Type: Simple

Note: This symbol is portrayed in conjunction with the Tidal Water symbol and shall mask out the Tidal Water symbol.

Component Ref #:	L00007	Component Type:	Line - Simple	Color Token:	Black
Description:	Black 0.1mm Solid Line				
Parameters:	<a href="#">Parameters:</a>				
Line Weight:	0.1mm				

Symbol Rules

Reference #:	Description:	Criteria:
PS-04756	Breakwater / dry (area)	Water Level Effect [WLE] = Always Dry [2], Floating [8], Not Applicable [998], Other [999], Unknown [0]

Label Rules

Label Placement Rules (see Annex J): LP-3505

Reference #:	Description:	Criteria:



PL-04756\_1 Breakwater / dry (area)

N/A

Label String: "Breakwater"  
 Characteristics: 1  
 1 (Black, Condensed, 6 pt, Mixed case)

Symbol Samples

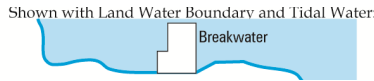

Breakwater / not dry (area)

Symbol Placement Instructions: The symbol is applied to the geometry of the feature.

Symbol Type: Complex



Symbol Graphic

Note: The symbol is shown in conjunction with with Tidal Water symbol and shall not mask out the Tidal Water symbol.

Component Ref #:	A00048	Component Type:	Area - Fill	Color Token:	Black-12
Description:	Black-12 area fill				
Parameters:					
Screen Angle:	15 degrees				
Screen Percent:	12%				

Component Ref #:	L00210	Component Type:	Line - Styled	Color Token:	Black
Description:	Black 0.1mm Dashed line (0.1mm wt, 1.0mm dash, 0.5mm gap)				
Parameters:					
Line Weight:	0.1mm	Dash Length:	1.0mm	Dash Spacing:	0.5mm

Symbol Rules

Reference #:	Description:	Criteria:
PS-04757	Breakwater / not dry (area)	Water Level Effect [WLE] = (Always Submerged [3], Covers and Uncovers [4], Partly Submerged [1])

Label Rules

Label Placement Rules (see Annex J): LP-3505

Reference #:	Description:	Criteria:
PL-04757_1	Breakwater / not dry (area)	N/A

Label String: "Breakwater"  
 Characteristics: 1  
 1 (Black, Condensed, 6 pt, Mixed case)

Symbol Samples



Breakwater / dry (line)

Symbol Placement Instructions: The symbol is applied to the geometry of the feature.

Symbol Type: Simple



Symbol Graphic

Component Ref #: L00009      Component Type: Line - Simple      Color Token: Black  
 Description: Black 0.2mm Solid Line  
Parameters:  
 Line Weight: 0.2mm

**Symbol Rules**

Reference #: Description: Criteria:  
**PS-04758 Breakwater / dry (line)** Water Level Effect [WLE] = Always Dry [2], Floating [8], Not Applicable [998], Other [999], Unknown [0]

**Label Rules**

Label Placement Rules (see Annex J): LP-3505

Reference #: Description: Criteria:  
**PL-04758\_1 Breakwater / dry (line)** N/A

Label String: "Breakwater"  
 Characteristics: 1  
 1 (Black, Condensed, 6 pt, Mixed case)

**Symbol Samples**



**Breakwater / not dry (line)**

Symbol Placement Instructions: The symbol is applied to the geometry of the feature.  
 Symbol Type: Simple

Symbol Graphic

Component Ref #: L00031      Component Type: Line - Styled      Color Token: Black  
 Description: Black 0.2mm Dashed Line (0.2mm wt, 1.0mm dash, 0.5mm gap)  
Parameters:  
 Line Weight: 0.2mm      Dash Length: 1.0mm      Dash Spacing: 0.5mm

**Symbol Rules**

Reference #: Description: Criteria:  
**PS-04759 Breakwater / not dry (line)** Water Level Effect [WLE] = (Always Submerged [3], Covers and Uncovers [4], Partly Submerged [1])

**Label Rules**

Label Placement Rules (see Annex J): LP-3505

Reference #: Description: Criteria:  
**PL-04759\_1 Breakwater / not dry (line)** N/A

Label String: "Breakwater"  
 Characteristics: 1  
 1 (Black, Condensed, 6 pt, Mixed case)

**Symbol Samples**

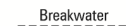

**Bridge (AQ040)**

Generalization Rules (see Annex J): GA-9999, GC-9979, GC-9997

## Bridge / fixed / non-pedestrian (line)



Symbol Graphic

**Symbol Placement Instructions:** The symbol is applied to the geometry of the feature.

**Symbol Type:** Complex

**Note:** Four Components P00038 are fixed at the start and end of Component L00019. Ticks are angled 45, 135, 225, and 315 degrees outward depending on which end of the line they are placed. See Component P00188 in Annex H for additional drawing instructions.

<b>Component Ref #:</b>	L00019	<b>Component Type:</b>	Line - Simple	<b>Color Token:</b>	Black
<b>Description:</b>	Two parallel Black 0.3mm Solid Lines				
<b>Parameters:</b>					
<b>Line Weight:</b>	0.3mm				
<b>Note:</b>	Spacing is variable based on the width of the overpassing feature.				

<b>Component Ref #:</b>	P00038	<b>Component Type:</b>	Point - Simple	<b>Color Token:</b>	Black
<b>Description:</b>	Black 0.75mm length line with a 0.15mm lineweight				
<b>Parameters:</b>					
<b>Line Weight:</b>	0.15mm				
<b>Length:</b>	0.75mm				

### Symbol Rules

<b>Reference #:</b>	<b>Description:</b>	<b>Criteria:</b>
PS-04130	Bridge / fixed / non-pedestrian (line)	Bridge Opening Type [BOT] = (Fixed [17], Not Applicable [998], Unknown [0])
	AND	Transportation System Type [TRS] = (Aeronautical [1], Aqueduct [2], Bus [4], Canal [5], Maritime [7], Not Applicable [998], Other [999], Pipeline [10], Railway [12], Road [13], Unknown [0])

### Label Rules

Label Placement Rules (see Annex J): LP-3505, LP-9950, LP-9999

<b>Reference #:</b>	<b>Description:</b>	<b>Criteria:</b>
PL-04130_1	Bridge / fixed / non-pedestrian / intact (line)	Condition of Facility [FUN] = (Fully Functional [6], Unknown [0])
	<b>Label String:</b> [Name]	
	<b>Characteristics:</b> 1	
	1 (Black, Condensed, 6 pt, Mixed case)	
PL-04130_2	Bridge / fixed / non-pedestrian / not intact (line)	Condition of Facility [FUN] = (Abandoned [2], Damaged [13], Destroyed [3], Dismantled [4], Under Construction [1])
	<b>Label String:</b> [Name] "["[Condition of Facility]"	
	<b>Characteristics:</b> 1, 22, 22, 22	
	1 (Black, Condensed, 6 pt, Mixed case)	
	22 (Black, Condensed, 6 pt, Lower case)	

### Symbol Samples



## Bridge / non-fixed / non-pedestrian (line)

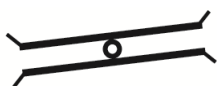

Symbol Graphic

**Symbol Placement Instructions:** The symbol is applied to the geometry of the feature.

**Symbol Type:** Complex

**Note:** Four Components P00038 are fixed at the start and end of Component L00019. They are angled 45, 135, 225, and 315 degrees outward depending on which end of the line they are placed. Component P00048 is centered between the lines of Component L00019. See Component P00202 in Annex H for additional drawing instructions.

Component Ref #: L00019      Component Type: Line - Simple      Color Token: Black  
 Description: Two parallel Black 0.3mm Solid Lines  
[Parameters:](#)  
 Line Weight: 0.3mm  
 Note: Spacing is variable based on the width of the overpassing feature.

Component Ref #: P00038      Component Type: Point - Simple      Color Token: Black  
 Description: Black 0.75mm length line with a 0.15mm lineweight  
[Parameters:](#)  
 Line Weight: 0.15mm  
 Length: 0.75mm

Component Ref #: P00048      Component Type: Point - Simple      Color Token: Black  
 Description: Bridge non-fixed open circle  
[Parameters:](#)  
 Line Weight: 0.2mm  
 Note: The diameter of the open circle is variable based on the width of the overpassing feature.

**Symbol Rules**

Reference #: **PS-04131**      Description: **Bridge / non-fixed / non-pedestrian (line)**      Criteria:  
 Bridge Opening Type [BOT] = (Bascule [4], Lift-bridge [11], Retractable [12], Swing-bridge [10])  
 AND  
 Transportation System Type [TRS] = (Aeronautical [1], Aqueduct [2], Bus [4], Canal [5], Maritime [7], Not Applicable [998], Other [999], Pipeline [10], Railway [12], Road [13], Unknown [0])

**Label Rules**

Label Placement Rules (see Annex J): LP-3505, LP-9950, LP-9999

Reference #: **PL-04131\_1**      Description: **Bridge / non-fixed / non-pedestrian / intact (line)**      Criteria:  
 Condition of Facility [FUN] = (Fully Functional [6], Unknown [0])

Label String: [Name]  
 Characteristics: 1  
 1 (Black, Condensed, 6 pt, Mixed case)

Reference #: **PL-04131\_2**      Description: **Bridge / non-fixed / non-pedestrian / not intact (line)**      Criteria:  
 Condition of Facility [FUN] = (Abandoned [2], Damaged [13], Destroyed [3], Dismantled [4], Under Construction [1])

Label String: [Name] "["[Condition of Facility]"  
 Characteristics: 1, 22, 22, 22  
 1 (Black, Condensed, 6 pt, Mixed case)  
 22 (Black, Condensed, 6 pt, Lower case)

**Symbol Samples**

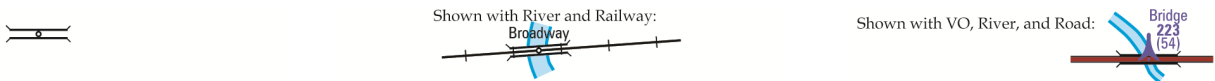

**Bridge / pedestrian (line)**



Symbol Placement Instructions: The symbol is applied to the geometry of the feature.

Symbol Type: Complex

Note: Apex of Component P00105 is fixed at start and end of Component L00011 with each "V" facing away. The 90 degree angle of the "V" is bisected equally by the line component.

Component Ref #: L00011      Component Type: Line - Simple      Color Token: Black  
 Description: Black 0.3mm Solid Line  
[Parameters:](#)  
 Line Weight: 0.3mm

Component Ref #: P00105      Component Type: Point - Shape      Color Token: Black  
 Description: Lock/pedestrian bridge/sluice gate "V"  
Parameters:  
 Note: See Annex H for detailed drawing instructions.

**Symbol Rules**

Reference #: **PS-04132**      Description: **Bridge / pedestrian (line)**      Criteria: Transportation System Type [TRS] = Pedestrian [9]

**Symbol Samples**



**Bridge / fixed / non-pedestrian (point)**



Symbol Graphic

Symbol Placement Instructions: Origin: Center of symbol

Symbol Type: Simple

Note: The symbol shall be aligned along the associated transportation feature.

Component Ref #: P00188      Component Type: Point - Shape      Color Token: Black  
 Description: Bridge fixed  
Parameters:  
 Note: See Annex H for detailed drawing instructions.

**Symbol Rules**

Reference #: **PS-04470**      Description: **Bridge / fixed / non-pedestrian (point)**      Criteria: Bridge Opening Type [BOT] = (Fixed [17], Not Applicable [998], Unknown [0])  
 AND Transportation System Type [TRS] = (Aeronautical [1], Aqueduct [2], Bus [4], Canal [5], Maritime [7], Not Applicable [998], Other [999], Pipeline [10], Railway [12], Road [13], Unknown [0])

**Label Rules**

Label Placement Rules (see Annex J): LP-3505, LP-9950, LP-9999

Reference #: **PL-04470\_1**      Description: **Bridge / fixed / non-pedestrian / intact (point)**      Criteria: Condition of Facility [FUN] = (Fully Functional [6], Unknown [0])

Label String: [Name]  
 Characteristics: 1  
 1 (Black, Condensed, 6 pt, Mixed case)

Reference #: **PL-04470\_2**      Description: **Bridge / fixed / non-pedestrian / not intact (point)**      Criteria: Condition of Facility [FUN] = (Abandoned [2], Damaged [13], Destroyed [3], Dismantled [4], Under Construction [1])

Label String: [Name] "["[Condition of Facility]"  
 Characteristics: 1, 22, 22, 22  
 1 (Black, Condensed, 6 pt, Mixed case)  
 22 (Black, Condensed, 6 pt, Lower case)

**Symbol Samples**



**Bridge / non-fixed / non-pedestrian (point)**



Symbol Graphic

Symbol Placement Instructions: Origin: Center of symbol

Symbol Type: Simple

Note: The symbol shall be aligned along the associated transportation feature.

Component Ref #:	P00202	Component Type:	Point - Shape	Color Token:	Black
Description:	Bridge not fixed				
Parameters:					
Note:	See Annex H for detailed drawing instructions.				

### Symbol Rules

Reference #:	Description:	Criteria:
PS-04650	Bridge / non-fixed / non-pedestrian (point)	Bridge Opening Type [BOT] = (Bascule [4], Lift-bridge [11], Retractable [12], Swing-bridge [10])
	AND	Transportation System Type [TRS] = (Aeronautical [1], Aqueduct [2], Bus [4], Canal [5], Maritime [7], Not Applicable [998], Other [999], Pipeline [10], Railway [12], Road [13], Unknown [0])

### Label Rules

Label Placement Rules (see Annex J): LP-3505, LP-9950, LP-9999

Reference #:	Description:	Criteria:
PL-04650_1	Bridge / non-fixed / non-pedestrian/ intact (point)	Condition of Facility [FUN] = (Fully Functional [6], Unknown [0])
	Label String: [Name]	
	Characteristics: 1 1 (Black, Condensed, 6 pt, Mixed case)	
PL-04650_2	Bridge / non-fixed / non-pedestrian / not intact (point)	Condition of Facility [FUN] = (Abandoned [2], Damaged [13], Destroyed [3], Dismantled [4], Under Construction [1])
	Label String: [Name] "["[Condition of Facility]"	
	Characteristics: 1, 22, 22, 22 1 (Black, Condensed, 6 pt, Mixed case) 22 (Black, Condensed, 6 pt, Lower case)	

### Symbol Samples



## Bridge / pedestrian (point)



Symbol Graphic

Symbol Placement Instructions: Origin: Center of symbol

Symbol Type: Simple

Note: The symbol shall be aligned along the associated transportation feature.

Component Ref #:	P00201	Component Type:	Point - Shape	Color Token:	Black
Description:	Bridge pedestrian				
Parameters:					
Note:	See Annex H for detailed drawing instructions.				

### Symbol Rules

Reference #:	Description:	Criteria:
PS-04645	Bridge / pedestrian (point)	Transportation System Type [TRS] = Pedestrian [9]

### Symbol Samples

×

## Built Up Area (AL020)

Generalization Rules (see Annex J): GA-9999

### Built Up Area / intact / dense (area)



Symbol Graphic

Symbol Placement Instructions: The symbol is applied to the geometry of the feature.

Symbol Type: Complex

Note: Component L00007 is applied to the perimeter and is filled with Component A00005.

Component Ref #:	A00005	Component Type:	Area - Fill	Color Token:	Dk-Brown1815-42
Description:	Dk-Brown1815-42 area fill				
Parameters:					
Screen Angle:	45 degrees				
Screen Percent:	42%				

Component Ref #:	L00007	Component Type:	Line - Simple	Color Token:	Black
Description:	Black 0.1mm Solid Line				
Parameters:					
Line Weight:	0.1mm				

### Symbol Rules

Reference #:	Description:	Criteria:
PS-04068	<b>Built Up Area / intact / dense (area)</b>	Condition of Facility [FUN] = (Fully Functional [6], Unknown [0]) AND Built-up Area Density Category [BAC] = Dense [2]

### Label Rules

Label Placement Rules (see Annex J): LP-3506, LP-9999

Reference #:	Description:	Criteria:
PL-04068_1	<b>Built Up Area / intact / dense / 1st class (area)</b>	Relative Importance [ORD] = First [1]
	Label String: [Name]	
	Characteristics: 47 47 (Black, Condensed, Bold, 14 pt, Upper case)	
PL-04068_2	<b>Built Up Area / intact / dense / 2nd class (area)</b>	Relative Importance [ORD] = Second [2]
	Label String: [Name]	
	Characteristics: 48 48 (Black, Condensed, Bold, 10 pt, Upper case)	
PL-04068_3	<b>Built Up Area / intact / dense / 3rd class (area)</b>	Relative Importance [ORD] = Third [3]
	Label String: [Name]	
	Characteristics: 49 49 (Black, Condensed, Bold, 10 pt, Mixed case)	
PL-04068_4	<b>Built Up Area / intact / dense / 4th class (area)</b>	Relative Importance [ORD] = Fourth [4]
	Label String: [Name]	
	Characteristics: 50 50 (Black, Condensed, 10 pt, Mixed case)	

**PL-04068\_5 Built Up Area / intact / dense / 5th class (area)**

Relative Importance [ORD] = (Fifth [5], Other [999], Unknown [0])

Label String: [Name]  
 Characteristics: 42  
 42 (Black, Condensed, 8 pt, Mixed case)

Symbol Samples



**Built Up Area / intact / sparse or moderate (area)**



Symbol Graphic

Symbol Placement Instructions: The symbol is applied to the geometry of the feature.

Symbol Type: Complex

Note: Component L00007 is applied to the perimeter and is filled with Component A00121.

Component Ref #: A00121      Component Type: Area - Fill      Color Token: Dk-Brown1815-21  
 Description: Dk-Brown1815-21 area fill  
Parameters:  
 Screen Angle: 45 degrees  
 Screen Percent: 21%

Component Ref #: L00007      Component Type: Line - Simple      Color Token: Black  
 Description: Black 0.1mm Solid Line  
Parameters:  
 Line Weight: 0.1mm

Symbol Rules

Reference #: Description: Criteria:  
**PS-04069 Built Up Area / intact / sparse or moderate (area)**      Condition of Facility [FUN] = (Fully Functional [6], Unknown [0])  
 AND      Built-up Area Density Category [BAC] = (Sparse [1], Unknown [0])

Label Rules

Label Placement Rules (see Annex J): LP-3506, LP-9999

Reference #: Description: Criteria:  
**PL-04069\_1 Built Up Area / intact / sparse or moderate / 1st class (area)**      Relative Importance [ORD] = First [1]

Label String: [Name]  
 Characteristics: 47  
 47 (Black, Condensed, Bold, 14 pt, Upper case)

**PL-04069\_2 Built Up Area / intact / sparse or moderate / 2nd class (area)**      Relative Importance [ORD] = Second [2]

Label String: [Name]  
 Characteristics: 48  
 48 (Black, Condensed, Bold, 10 pt, Upper case)

**PL-04069\_3 Built Up Area / intact / sparse or moderate / 3rd class (area)**      Relative Importance [ORD] = Third [3]

Label String: [Name]  
 Characteristics: 49  
 49 (Black, Condensed, Bold, 10 pt, Mixed case)

**PL-04069\_4 Built Up Area / intact / sparse or moderate / 4th class (area)**      Relative Importance [ORD] = Fourth [4]

Label String: [Name]  
 Characteristics: 50  
 50 (Black, Condensed, 10 pt, Mixed case)



**PL-04069\_5 Built Up Area / intact / sparse or moderate / 5th class (area)**

Relative Importance [ORD] = (Fifth [5], Other [999], Unknown [0])

Label String: [Name]  
 Characteristics: 42  
 42 (Black, Condensed, 8 pt, Mixed case)

Symbol Samples



**Built Up Area / not intact (area)**

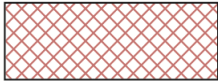

Symbol Graphic

Symbol Placement Instructions: The symbol is applied to the geometry of the feature.

Symbol Type: Complex

Note: Component L00007 is applied to the perimeter and is filled with Component A00063.

Component Ref #: A00063      Component Type: Area - Pattern      Color Token: Dk-Brown1815-54  
 Description: Dk-Brown1815-54 Not Intact BUA Screened Fill  
 Parameters:  
 Area Pattern: LP-6, see Annex I  
 Screen Angle: 45 degrees  
 Screen Percent: 54%

Component Ref #: L00007      Component Type: Line - Simple      Color Token: Black  
 Description: Black 0.1mm Solid Line  
 Parameters:  
 Line Weight: 0.1mm

Symbol Rules

Reference #: Description: Criteria:  
**PS-04070 Built Up Area / not intact (area)**      Condition of Facility [FUN] = (Abandoned [2], Damaged [13], Destroyed [3], Dismantled [4], Under Construction [1])

Label Rules

Label Placement Rules (see Annex J): LP-3506, LP-9950, LP-9999

Reference #: Description: Criteria:  
**PL-04070\_1 Built Up Area / not intact (area)**      N/A

Label String: [Name] "("[Condition of Facility]"")"  
 Characteristics: 42, 22, 22, 22  
 42 (Black, Condensed, 8 pt, Mixed case)  
 22 (Black, Condensed, 6 pt, Lower case)

Symbol Samples



**Built Up Area / all (point)**

[NAM]

Symbol Graphic

Symbol Placement Instructions: Text label only. No graphic parameters

Symbol Type: Simple

Symbol Rules

Reference #:	Description:	Criteria:
PS-04072	Built Up Area / all (point)	All

Label Rules

Label Placement Rules (see Annex J): LP-3505, LP-9950, LP-9999

Reference #:	Description:	Criteria:
PL-04072_1	Built Up Area / intact (point)	Condition of Facility [FUN] = (Fully Functional [6], Unknown [0])

Label String: [Name]  
 Characteristics: 42  
 42 (Black, Condensed, 8 pt, Mixed case)

Reference #:	Description:	Criteria:
PL-04072_2	Built Up Area /not intact (point)	Condition of Facility [FUN] = (Abandoned [2], Damaged [13], Destroyed [3], Dismantled [4], Under Construction [1])

Label String: [Name] "["[Condition of Facility]""]  
 Characteristics: 42, 22, 22, 22  
 42 (Black, Condensed, 8 pt, Mixed case)  
 22 (Black, Condensed, 6 pt, Lower case)

Symbol Samples

Monroe

Apua (destroyed)

Cableway (AT041)

Generalization Rules (see Annex J): GA-9999, GC-9988

Cableway / non-obstruction (line)

Symbol Placement Instructions: The symbol is applied to the geometry of the feature.

Symbol Type: Simple

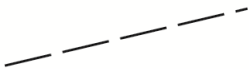

Symbol Graphic

Component Ref #:	L00032	Component Type:	Line - Styled	Color Token:	Black
Description:	Black 0.2mm Dashed Line (0.2mm wt, 2.0mm dash, 0.5mm gap)				
Parameters:					
Line Weight:	0.2mm	Dash Length:	2.0mm	Dash Spacing:	0.5mm

Symbol Rules

Reference #:	Description:	Criteria:
PS-04155	Cableway / non-obstruction (line)	Height Above Surface Level [HGT] < 46

Label Rules

Label Placement Rules (see Annex J): LP-3630, LP-9999

Reference #:	Description:	Criteria:
PL-04155_1	Cableway / non-obstruction / recreational (line)	Cableway Type [CAT] = (Aerial Tramway [5], Chair-lift [2], Gondola Lift [6], Industrial Ropeway [8], Material Tramway [9])

Label String: [Cableway Type]  
 Characteristics: 1

1 (Black, Condensed, 6 pt, Mixed case)

**PL-04155\_2 Cableway / non-obstruction / other (line)**

Cableway Type [CAT] = (Not Applicable [998], Other [999], Unknown [0])

Label String: "Cableway"  
 Characteristics: 1  
 1 (Black, Condensed, 6 pt, Mixed case)

Symbol Samples



**Cableway / obstruction (line)**



Symbol Graphic

Symbol Placement Instructions: The symbol is applied to the geometry of the feature.  
 Symbol Type: Simple

Component Ref #:	L00006	Component Type:	Line - Simple	Color Token:	Blue072
Description:	Blue072 0.73mm Solid Line				
Parameters:	Line Weight: 0.73mm				

Symbol Rules

Reference #:	Description:	Criteria:
PS-04158	Cableway / obstruction (line)	Height Above Surface Level [HGT] >= 46

Label Rules

Label Placement Rules (see Annex J): LP-9991

Reference #:	Description:	Criteria:
PL-04158_1	Cableway / obstruction (line)	N/A

Label String: "Cableway"  
 [Highest Elevation]  
 ("[Height Above Surface Level]")  
 Characteristics: 15  
 46  
 95, 95, 95  
 15 (Blue072, Condensed, 6 pt, Mixed case)  
 46 (Blue072, Condensed, Bold, 6 pt, Lower case)

Symbol Samples



**Cairn (AL025)**

**Cairn / all (point)**



Symbol Graphic

Symbol Placement Instructions: Origin: Center of small circle

Symbol Type: Simple

Component Ref #:	P00022	Component Type:	Point - Shape	Color Token:	Black
Description:	Cairn				
<a href="#">Parameters:</a>					
Note:	See Annex H for detailed drawing instructions.				

Symbol Rules

Reference #:	Description:	Criteria:
PS-04073	Cairn / all (point)	All

Label Rules

Label Placement Rules (see Annex J):	LP-3505	
Reference #:	Description:	Criteria:
PL-04073_1	Cairn / all (point)	N/A
Label String:	"Cairn"	
Characteristics:	1 1 (Black, Condensed, 6 pt, Mixed case)	

Symbol Samples



Camp (AI030)

Generalization Rules (see Annex J): GA-9999, GC-9999

Camp / all (area)

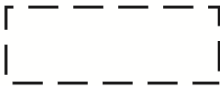

Symbol Graphic

Symbol Placement Instructions: The symbol is applied to the geometry of the feature.

Symbol Type: Simple

Component Ref #:	L00210	Component Type:	Line - Styled	Color Token:	Black
Description:	Black 0.1mm Dashed line (0.1mm wt, 1.0mm dash, 0.5mm gap)				
<a href="#">Parameters:</a>					
Line Weight:	0.1mm	Dash Length:	1.0mm	Dash Spacing:	0.5mm

Symbol Rules

Reference #:	Description:	Criteria:
PS-04481	Camp / all (area)	All

Label Rules

Label Placement Rules (see Annex J):	LP-3506, LP-4813, LP-9999	
Reference #:	Description:	Criteria:
PL-04481_1	Camp / all (area)	N/A
Label String:	[Name] "Camp"	
Characteristics:	1, 1 1 (Black, Condensed, 6 pt, Mixed case)	

Symbol Samples



Camp / all (point)



Symbol Graphic

Symbol Placement Instructions: Origin: Center of symbol

Symbol Type: Simple

Component Ref #:	P00005	Component Type:	Point - Shape	Color Token:	Black
Description:	Camp/campsite				
Parameters:					
Note:	See Annex H for detailed drawing instructions.				

Symbol Rules

Reference #:	Description:	Criteria:
PS-04480	Camp / all (point)	All

Label Rules

Label Placement Rules (see Annex J): LP-3505, LP-4813, LP-9999

Reference #:	Description:	Criteria:
PL-04480_1	Camp / all (point)	N/A

Label String: [Name] "Camp"  
 Characteristics: 1, 1  
 1 (Black, Condensed, 6 pt, Mixed case)

Symbol Samples



Camp Site (AK060)

Generalization Rules (see Annex J): GA-9999, GC-9999

Camp Site / all (area)



Symbol Graphic

Symbol Placement Instructions: The symbol is applied to the geometry of the feature.

Symbol Type: Simple

Component Ref #:	L00210	Component Type:	Line - Styled	Color Token:	Black
Description:	Black 0.1mm Dashed line (0.1mm wt, 1.0mm dash, 0.5mm gap)				
Parameters:					
Line Weight:	0.1mm	Dash Length:	1.0mm	Dash Spacing:	0.5mm

Symbol Rules

Reference #:	Description:	Criteria:
PS-04022	Camp Site / all (area)	All

Label Rules

Label Placement Rules (see Annex J): LP-3506, LP-4813, LP-9999

Reference #: Description: Criteria:  
**PL-04022\_1** **Camp Site / all (area)** N/A

Label String: [Name] "Campsite"  
 Characteristics: 1, 1  
 1 (Black, Condensed, 6 pt, Mixed case)

Symbol Samples



Camp Site / all (point)



Symbol Graphic

Symbol Placement Instructions: Origin: Center of symbol  
 Symbol Type: Simple

Component Ref #: P00005 Component Type: Point - Shape Color Token: Black  
 Description: Camp/campsite  
[Parameters:](#)  
 Note: See Annex H for detailed drawing instructions.

Symbol Rules

Reference #: Description: Criteria:  
**PS-04482** **Camp Site / all (point)** All

Label Rules

Label Placement Rules (see Annex J): LP-3505, LP-4813, LP-9999

Reference #: Description: Criteria:  
**PL-04482\_1** **Camp Site / all (point)** N/A

Label String: [Name] "Campsite"  
 Characteristics: 1, 1  
 1 (Black, Condensed, 6 pt, Mixed case)

Symbol Samples



Canal (BH020)

Generalization Rules (see Annex J): GA-9999

Canal / intact / perennial (area)

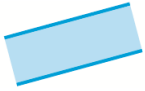

Symbol Graphic

**Symbol Placement Instructions:** The symbol is applied to the geometry of the feature.

**Symbol Type:** Complex

**Note:** Component L00015 is applied to the perimeter and is filled with Component A00007.

<b>Component Ref #:</b>	A00007	<b>Component Type:</b>	Area - Fill	<b>Color Token:</b>	Cyan-31
<b>Description:</b>	Cyan-31 area fill				
<b>Parameters:</b>					
<b>Screen Angle:</b>	45 degrees				
<b>Screen Percent:</b>	31%				

<b>Component Ref #:</b>	L00015	<b>Component Type:</b>	Line - Simple	<b>Color Token:</b>	Cyan
<b>Description:</b>	Cyan 0.2mm Solid Line				
<b>Parameters:</b>					
<b>Line Weight:</b>	0.2mm				

**Symbol Rules**

<b>Reference #:</b>	<b>Description:</b>	<b>Criteria:</b>
PS-04023	Canal / intact / perennial (area)	Condition of Facility [FUN] = (Fully Functional [6], Unknown [0]) AND Hydrologic Persistence [HYP] = (Perennial [1], Unknown [0])

**Label Rules**

**Label Placement Rules (see Annex J):** LP-0062, LP-4813, LP-9997, LP-9999

<b>Reference #:</b>	<b>Description:</b>	<b>Criteria:</b>
PL-04023_1	Canal / intact / perennial / on ground (area)	Vertical Relative Location [LOC] = (On Surface [44], Unknown [0])
	<b>Label String:</b> [Name] "CANAL"	
	<b>Characteristics:</b> 37, 37 37 (Cyan, Condensed, Italic, 7-16 pt, Upper case)	
PL-04023_2	Canal / intact / perennial / elevated (area)	Vertical Relative Location [LOC] = Above Surface [45]
	<b>Label String:</b> [Name] "CANAL" "(ELEVATED)"	
	<b>Characteristics:</b> 37, 37, 37 37 (Cyan, Condensed, Italic, 7-16 pt, Upper case)	
PL-04023_3	Canal / intact / perennial / underground (area)	Vertical Relative Location [LOC] = Below Ground Surface [40]
	<b>Label String:</b> [Name] "CANAL" "(UNDERGROUND)"	
	<b>Characteristics:</b> 37, 37, 37 37 (Cyan, Condensed, Italic, 7-16 pt, Upper case)	

**Symbol Samples**



**Canal / intact / intermittent, dry (area)**

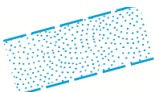

Symbol Graphic

**Symbol Placement Instructions:** The symbol is applied to the geometry of the feature.

**Symbol Type:** Complex

**Note:** Component L00041 is applied to the perimeter and is filled with Component A00020.

<b>Component Ref #:</b>	A00020	<b>Component Type:</b>	Area - Pattern	<b>Color Token:</b>	Cyan
<b>Description:</b>	Cyan Dry Drainage Fill				
<b>Parameters:</b>					

Area Pattern: AP-95, see Annex I

Component Ref #:	L00041	Component Type:	Line - Styled	Color Token:	Cyan
Description:	Cyan 0.2mm Dashed Line (0.2mm wt, 2.0mm dash, 0.5mm gap)				
Parameters:					
Line Weight:	0.2mm	Dash Length:	2.0mm	Dash Spacing:	0.5mm

**Symbol Rules**

Reference #:	Description:	Criteria:
PS-04024	Canal / intact / intermittent, dry (area)	Condition of Facility [FUN] = (Fully Functional [6], Unknown [0])
	AND	Hydrologic Persistence [HYP] = (Dry [4], Intermittent [2])

**Label Rules**

Label Placement Rules (see Annex J): LP-0062, LP-4813, LP-9997, LP-9999

Reference #:	Description:	Criteria:
PL-04024_1	Canal / intact / intermittent, dry / on ground (area)	Vertical Relative Location [LOC] = (On Surface [44], Unknown [0])
	Label String: [Name] "CANAL"	
	Characteristics: 37, 37 37 (Cyan, Condensed, Italic, 7-16 pt, Upper case)	
PL-04024_2	Canal / intact / intermittent, dry / elevated (area)	Vertical Relative Location [LOC] = Above Surface [45]
	Label String: [Name] "CANAL" "(ELEVATED)"	
	Characteristics: 37, 37, 37 37 (Cyan, Condensed, Italic, 7-16 pt, Upper case)	
PL-04024_3	Canal / intact / intermittent, dry / underground (area)	Vertical Relative Location [LOC] = Below Ground Surface [40]
	Label String: [Name] "CANAL" "(UNDERGROUND)"	
	Characteristics: 37, 37, 37 37 (Cyan, Condensed, Italic, 7-16 pt, Upper case)	

**Symbol Samples**



**Canal / not intact (area)**

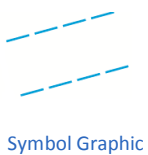

Symbol Placement Instructions: The symbol is applied to the geometry of the feature.  
Symbol Type: Simple

Component Ref #:	L00041	Component Type:	Line - Styled	Color Token:	Cyan
Description:	Cyan 0.2mm Dashed Line (0.2mm wt, 2.0mm dash, 0.5mm gap)				
Parameters:					
Line Weight:	0.2mm	Dash Length:	2.0mm	Dash Spacing:	0.5mm

**Symbol Rules**

Reference #:	Description:	Criteria:
PS-04025	Canal / not intact (area)	Condition of Facility [FUN] = (Abandoned [2], Damaged [13], Destroyed [3], Dismantled [4], Under Construction [1])

**Label Rules**

Label Placement Rules (see Annex J): LP-0062, LP-4813, LP-9950, LP-9997, LP-9999

Reference #:	Description:	Criteria:
PL-04025_1	Canal / not intact / on ground (area)	Vertical Relative Location [LOC] = (On Surface [44], Unknown [0])



Label String: [Name] "Canal" "["[Condition of Facility]""]  
 Characteristics: 37, 37, 37, 37, 37  
 37 (Cyan, Condensed, Italic, 7-16 pt, Upper case)

**PL-04025\_2 Canal / not intact / elevated (area)** Vertical Relative Location [LOC] = Above Surface [45]

Label String: [Name] "CANAL" "(ELEVATED)" "["[Condition of Facility]""]  
 Characteristics: 37, 37, 37, 37, 37, 37  
 37 (Cyan, Condensed, Italic, 7-16 pt, Upper case)

**PL-04025\_3 Canal / not intact / underground (area)** Vertical Relative Location [LOC] = Below Ground Surface [40]

Label String: [Name] "CANAL" "(UNDERGROUND)" "["[Condition of Facility]""]  
 Characteristics: 37, 37, 37, 37, 37, 37  
 37 (Cyan, Condensed, Italic, 7-16 pt, Upper case)

Symbol Samples

*CANAL (CONSTRUCTION)*

*L & M CANAL (CONSTRUCTION)*

*CANAL (DAMAGED)*

Canal / intact / perennial (line)



Symbol Graphic

Symbol Placement Instructions: The symbol is applied to the geometry of the feature.  
 Symbol Type: Simple

Component Ref #:	L00017	Component Type:	Line - Simple	Color Token:	Cyan
Description:	Cyan 0.4mm Solid Line				
Parameters:					
Line Weight:	0.4mm				

Symbol Rules

Reference #:	Description:	Criteria:
PS-04026	Canal / intact / perennial (line)	Condition of Facility [FUN] = (Fully Functional [6], Unknown [0]) AND Hydrologic Persistence [HYP] = (Perennial [1], Unknown [0])

Label Rules

Label Placement Rules (see Annex J): LP-3630, LP-4813, LP-9999

Reference #:	Description:	Criteria:
PL-04026_1	Canal / intact / perennial / on ground (line)	Vertical Relative Location [LOC] = (On Surface [44], Unknown [0])

Label String: [Name] "Canal"  
 Characteristics: 16, 16  
 16 (Cyan, Condensed, Italic, 6 pt, Mixed case)

**PL-04026\_2 Canal / intact / perennial / elevated (line)** Vertical Relative Location [LOC] = Above Surface [45]

Label String: [Name] "Canal" "(elevated)"  
 Characteristics: 16, 16, 23  
 16 (Cyan, Condensed, Italic, 6 pt, Mixed case)  
 23 (Cyan, Condensed, Italic, 6 pt, Lower case)

**PL-04026\_3 Canal / intact / perennial / underground (line)** Vertical Relative Location [LOC] = Below Ground Surface [40]

Label String: [Name] "Canal" "(underground)"  
 Characteristics: 16, 16, 23  
 16 (Cyan, Condensed, Italic, 6 pt, Mixed case)  
 23 (Cyan, Condensed, Italic, 6 pt, Lower case)

Symbol Samples

**Canal / not intact / intermittent, dry (line)**



Symbol Graphic

Symbol Placement Instructions: The symbol is applied to the geometry of the feature.

Symbol Type: Simple

Component Ref #:	L00045	Component Type:	Line - Styled	Color Token:	Cyan
Description:	Cyan 0.4mm Dashed Line (0.4mm wt, 2.0mm dash, 0.5mm gap)				
Parameters:					
Line Weight:	0.4mm	Dash Length:	2.0mm	Dash Spacing:	0.5mm

**Symbol Rules**

Reference #:	Description:	Criteria:
PS-04027	Canal / not intact / intermittent, dry (line)	Condition of Facility [FUN] = (Abandoned [2], Damaged [13], Destroyed [3], Dismantled [4], Under Construction [1]) OR Hydrologic Persistence [HYP] = (Dry [4], Intermittent [2])

**Label Rules**

Label Placement Rules (see Annex J): LP-3630, LP-4813, LP-9950, LP-9999

Reference #:	Description:	Criteria:
PL-04027_1	Canal / not intact / on ground (line)	Condition of Facility [FUN] = (Abandoned [2], Damaged [13], Destroyed [3], Dismantled [4], Under Construction [1]) AND Vertical Relative Location [LOC] = (On Surface [44], Unknown [0])
	Label String: [Name] "Canal" ("[Condition of Facility]")	
	Characteristics: 16, 16, 23, 23, 23 16 (Cyan, Condensed, Italic, 6 pt, Mixed case) 23 (Cyan, Condensed, Italic, 6 pt, Lower case)	
PL-04027_2	Canal / not intact / elevated (line)	Condition of Facility [FUN] = (Abandoned [2], Damaged [13], Destroyed [3], Dismantled [4], Under Construction [1]) AND Vertical Relative Location [LOC] = Above Surface [45]
	Label String: [Name] "Canal" "(elevated)" ("[Condition of Facility]")	
	Characteristics: 16, 16, 23, 23, 23, 23 16 (Cyan, Condensed, Italic, 6 pt, Mixed case) 23 (Cyan, Condensed, Italic, 6 pt, Lower case)	
PL-04027_3	Canal / not intact / underground (line)	Condition of Facility [FUN] = (Abandoned [2], Damaged [13], Destroyed [3], Dismantled [4], Under Construction [1]) AND Vertical Relative Location [LOC] = Below Ground Surface [40]
	Label String: [Name] "Canal" "(underground)" ("[Condition of Facility]")	
	Characteristics: 16, 16, 23, 23, 23, 23 16 (Cyan, Condensed, Italic, 6 pt, Mixed case) 23 (Cyan, condensed, Italic, 6 pt, Lower case)	
PL-04027_4	Canal / intermittent, dry / on surface (line)	Condition of Facility [FUN] = (Fully Functional [6], Unknown [0]) AND Vertical Relative Location [LOC] = (On Surface [44], Unknown [0])
	Label String: [Name] "Canal"	
	Characteristics: 16, 16 16 (Cyan, Condensed, Italic, 6 pt, Mixed case)	

**PL-04027\_5 Canal / intermittent, dry / elevated (line)**

Condition of Facility [FUN] = (Fully Functional [6], Unknown [0])

AND Vertical Relative Location [LOC] = Above Surface [45]

Label String: [Name] "Canal" "(elevated)"  
 Characteristics: 16, 16, 23  
 16 (Cyan, Condensed, Italic, 6 pt, Mixed case)  
 23 (Cyan, Condensed, Italic, 6 pt, Lower case)

**PL-04027\_6 Canal / intermittent, dry / underground (line)**

Condition of Facility [FUN] = (Fully Functional [6], Unknown [0])

AND Vertical Relative Location [LOC] = Below Ground Surface [40]

Label String: [Name] "Canal" "(underground)"  
 Characteristics: 16, 16, 23  
 16 (Cyan, Condensed, Italic, 6 pt, Mixed case)  
 23 (Cyan, Condensed, Italic, 6 pt, Lower case)

**Symbol Samples**



**Cane (EC010)**

Generalization Rules (see Annex J): GA-9999

**Cane / all (area)**



Symbol Graphic

Symbol Placement Instructions: The symbol is applied to the geometry of the feature.

Symbol Type: Simple

Component Ref #:	A00050	Component Type:	Area - Pattern	Color Token:	Green362
Description:	Green362 Cane Fill				
Parameters:					
Area Pattern:	AP-86, see Annex I				

**Symbol Rules**

Reference #:	Description:	Criteria:
PS-04028	Cane / all (area)	All

**Symbol Samples**



**Cart Track (AP010)**

Generalization Rules (see Annex J): GA-9999

**Cart Track / all (line)**



Symbol Placement Instructions: The symbol is applied to the geometry of the feature.  
 Symbol Type: Simple

Symbol Graphic

Component Ref #:	L00035	Component Type:	Line - Styled	Color Token:	Black
Description:	Black 0.25mm Dashed Line (0.25mm wt, 3.5mm dash, 0.5mm gap)				
<u>Parameters:</u>					
Line Weight:	0.25mm	Dash Length:	3.5mm	Dash Spacing:	0.5mm

**Symbol Rules**

Reference #:	Description:	Criteria:
PS-04128	Cart Track / all (line)	All

**Label Rules**

Label Placement Rules (see Annex J): LP-3630

Reference #:	Description:	Criteria:
PL-04128_1	Cart Track / all (line)	Road Weather Restriction [WTC] = Winter Only [3]

Label String: "Winter only"  
 Characteristics: 10  
 10 (Black, Light Condensed, Italic, 6 pt, Mixed case)

**Symbol Samples**



**Catalytic Cracker (AC020)**

**Catalytic Cracker / non-obstruction / intact (point)**



Symbol Placement Instructions: Origin: Center of symbol  
 Symbol Type: Simple

Symbol Graphic

Component Ref #:	P00006	Component Type:	Point - Simple	Color Token:	Black
Description:	Black filled square with all sides 0.8mm				
<u>Parameters:</u>					
Length:	0.8mm				
Note:	The component is a square and is filled with the solid color.				

**Symbol Rules**

Reference #:	Description:	Criteria:
PS-04029	Catalytic Cracker / non-obstruction / intact (point)	Height Above Surface Level [HGT] < 46 AND Condition of Facility [FUN] = (Fully Functional [6], Unknown [0])

**Label Rules**

Label Placement Rules (see Annex J): LP-3505

Reference #:	Description:	Criteria:
PL-04029_1	Catalytic Cracker / non-obstruction / intact (point)	N/A

Label String: "Catalytic cracker"  
 Characteristics: 1

Symbol Samples

■ Catalytic cracker

**Catalytic Cracker / non-obstruction / not intact (point)**



Symbol Graphic

Symbol Placement Instructions: Origin: Center of symbol  
 Symbol Type: Simple

Component Ref #: P00293      Component Type: Point - Shape      Color Token: Black/Black-12  
 Description: Not intact square 0.6mm  
 Parameters:  
 Note: See Annex H for detailed drawing instructions.

Symbol Rules

Reference #:	Description:	Criteria:
PS-04752	<b>Catalytic Cracker / non-obstruction / not intact (point)</b>	Height Above Surface Level [HGT] < 46
	AND	Condition of Facility [FUN] = (Abandoned [2], Damaged [13], Destroyed [3], Dismantled [4], Under Construction [1])

Symbol Samples

□

**Causeway Structure (AQ063)**

Generalization Rules (see Annex J): GA-9999

**Causeway Structure / all (line)**

CAUSEWAY

Symbol Graphic

Symbol Placement Instructions: Text label only. No graphic parameters  
 Symbol Type: Simple

Symbol Rules

Reference #:	Description:	Criteria:
PS-04136	<b>Causeway Structure / all (line)</b>	All

Label Rules

Label Placement Rules (see Annex J): LP-3630

Reference #:	Description:	Criteria:
PL-04136_1	<b>Causeway Structure / all (line)</b>	N/A

Label String: "CAUSEWAY"  
 Characteristics: 27

27 (Black, Light Condensed, Italic, 6 pt, Upper case)

Symbol Samples

CAUSEWAY

Shown with Road, Land Water Boundary, and Tidal Water:



Cave Mouth (DB029)

Cave Mouth / all (point)



Symbol Graphic

Symbol Placement Instructions: Origin: Center of symbol

Symbol Type: Simple

Note: The narrow end of the symbol should be orientated towards the higher elevation.

Component Ref #:	P00183	Component Type:	Point - Shape	Color Token:	Black
Description:	Cave mouth				
Parameters:					
Note:	See Annex H for detailed drawing instructions.				

Symbol Rules

Reference #:	Description:	Criteria:
PS-04032	Cave Mouth / all (point)	All

Label Rules

Label Placement Rules (see Annex J): LP-3505, LP-9999

Reference #:	Description:	Criteria:
PL-04032_1	Cave Mouth / all (point)	N/A

Label String: [Name]  
 Characteristics: 1  
 1 (Black, Condensed, 6 pt, Mixed case)

Symbol Samples

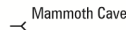

Cemetery (AL030)

Generalization Rules (see Annex J): GA-9999, GC-9982

Cemetery / other (area)



Symbol Graphic

Symbol Placement Instructions: The symbol is applied to the geometry of the feature.

Symbol Type: Complex

Note: Component P00271 is centered within Component L00210.

Component Ref #:	L00210	Component Type:	Line - Styled	Color Token:	Black
Description:	Black 0.1mm Dashed line (0.1mm wt, 1.0mm dash, 0.5mm gap)				
Parameters:					
Line Weight:	0.1mm	Dash Length:	1.0mm	Dash Spacing:	0.5mm

Component Ref #: P00271      Component Type: Point - Shape      Color Token: Black  
 Description: Cemetery/tomb other  
Parameters:  
 Note: See Annex H for detailed drawing instructions.

**Symbol Rules**

Reference #: Description: Criteria:  
**PS-04078 Cemetery / other (area)** Religious Designation [REL] = (Other [999], Unknown [0])

**Label Rules**

Label Placement Rules (see Annex J): LP-3506, LP-9999

Reference #: Description: Criteria:  
**PL-04078\_1 Cemetery / other (area)** N/A

Label String: [Name]  
 Characteristics: 1  
 1 (Black, Condensed, 6 pt, Mixed case)

**Symbol Samples**



**Cemetery / buddhism (area)**



Symbol Graphic

Symbol Placement Instructions: The symbol is applied to the geometry of the feature.

Symbol Type: Complex

Note: Component P00272 is centered within Component L00210.

Component Ref #: L00210      Component Type: Line - Styled      Color Token: Black  
 Description: Black 0.1mm Dashed line (0.1mm wt, 1.0mm dash, 0.5mm gap)  
Parameters:  
 Line Weight: 0.1mm      Dash Length: 1.0mm      Dash Spacing: 0.5mm

Component Ref #: P00272      Component Type: Point - Shape      Color Token: Black  
 Description: Cemetery/tomb Buddhism  
Parameters:  
 Note: See Annex H for detailed drawing instructions.

**Symbol Rules**

Reference #: Description: Criteria:  
**PS-04075 Cemetery / buddhism (area)** Religious Designation [REL] = Buddhism [1]

**Label Rules**

Label Placement Rules (see Annex J): LP-3506, LP-9999

Reference #: Description: Criteria:  
**PL-04075\_1 Cemetery / buddhism (area)** N/A

Label String: [Name]  
 Characteristics: 1  
 1 (Black, Condensed, 6 pt, Mixed case)

**Symbol Samples**

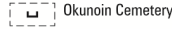

**Cemetery / christian (area)**



Symbol Graphic

**Symbol Placement Instructions:** The symbol is applied to the geometry of the feature.

**Symbol Type:** Complex

**Note:** Component P00253 is centered within Component L00210.

<b>Component Ref #:</b>	L00210	<b>Component Type:</b>	Line - Styled	<b>Color Token:</b>	Black
<b>Description:</b>	Black 0.1mm Dashed line (0.1mm wt, 1.0mm dash, 0.5mm gap)				
<b>Parameters:</b>					
<b>Line Weight:</b>	0.1mm	<b>Dash Length:</b>	1.0mm	<b>Dash Spacing:</b>	0.5mm
<b>Component Ref #:</b>	P00253	<b>Component Type:</b>	Point - Shape	<b>Color Token:</b>	Black
<b>Description:</b>	Cemetery/tomb Christian				
<b>Parameters:</b>					
<b>Note:</b>	See Annex H for detailed drawing instructions.				

**Symbol Rules**

<b>Reference #:</b>	<b>Description:</b>	<b>Criteria:</b>
PS-04076	Cemetery / christian (area)	Religious Designation [REL] = Christian [4]

**Label Rules**

<b>Label Placement Rules (see Annex J):</b>		LP-3506, LP-9999
<b>Reference #:</b>	<b>Description:</b>	<b>Criteria:</b>
PL-04076_1	Cemetery / christian (area)	N/A
<b>Label String:</b>	[Name]	
<b>Characteristics:</b>	1 1 (Black, Condensed, 6 pt, Mixed case)	

**Symbol Samples**



**Cemetery / islam (area)**



Symbol Graphic

**Symbol Placement Instructions:** The symbol is applied to the geometry of the feature.

**Symbol Type:** Complex

**Note:** Component P00254 is centered within Component L00210.

<b>Component Ref #:</b>	L00210	<b>Component Type:</b>	Line - Styled	<b>Color Token:</b>	Black
<b>Description:</b>	Black 0.1mm Dashed line (0.1mm wt, 1.0mm dash, 0.5mm gap)				
<b>Parameters:</b>					
<b>Line Weight:</b>	0.1mm	<b>Dash Length:</b>	1.0mm	<b>Dash Spacing:</b>	0.5mm
<b>Component Ref #:</b>	P00254	<b>Component Type:</b>	Point - Shape	<b>Color Token:</b>	Black
<b>Description:</b>	Cemetery/tomb Islam				
<b>Parameters:</b>					



Note: See Annex H for detailed drawing instructions.

**Symbol Rules**

Reference #: **PS-04074** Description: **Cemetery / islam (area)** Criteria: Religious Designation [REL] = Islam [2]

**Label Rules**

Label Placement Rules (see Annex J): LP-3506, LP-9999

Reference #: **PL-04074\_1** Description: **Cemetery / islam (area)** Criteria: N/A

Label String: [Name]  
 Characteristics: 1  
 1 (Black, Condensed, 6 pt, Mixed case)

**Symbol Samples**



**Cemetery / judaism (area)**

Symbol Placement Instructions: The symbol is applied to the geometry of the feature.

Symbol Type: Complex



Symbol Graphic

Note: Component P00255 is centered within Component L00210.

Component Ref #:	L00210	Component Type:	Line - Styled	Color Token:	Black
Description:	Black 0.1mm Dashed line (0.1mm wt, 1.0mm dash, 0.5mm gap)				
Parameters:					
Line Weight:	0.1mm	Dash Length:	1.0mm	Dash Spacing:	0.5mm

Component Ref #:	P00255	Component Type:	Point - Shape	Color Token:	Black
Description:	Cemetery/tomb Judaism				
Parameters:					
Note:	See Annex H for detailed drawing instructions.				

**Symbol Rules**

Reference #: **PS-04077** Description: **Cemetery / judaism (area)** Criteria: Religious Designation [REL] = Judaism [5]

**Label Rules**

Label Placement Rules (see Annex J): LP-3506, LP-9999

Reference #: **PL-04077\_1** Description: **Cemetery / judaism (area)** Criteria: N/A

Label String: [Name]  
 Characteristics: 1  
 1 (Black, Condensed, 6 pt, Mixed case)

**Symbol Samples**



**Cemetery / other (point)**



Symbol Graphic

Symbol Placement Instructions: Origin: Center of symbol

Symbol Type: Simple

Component Ref #: P00271      Component Type: Point - Shape      Color Token: Black  
 Description: Cemetery/tomb other  
[Parameters:](#)  
 Note: See Annex H for detailed drawing instructions.

**Symbol Rules**

Reference #: Description: Criteria:  
**PS-04083**    **Cemetery / other (point)**      Religious Designation [REL] = (Other [999], Unknown [0])

**Label Rules**

Label Placement Rules (see Annex J): LP-3505, LP-9999

Reference #: Description: Criteria:  
**PL-04083\_1**    **Cemetery / other (point)**      N/A

Label String: [Name]  
 Characteristics: 1  
 1 (Black, Condensed, 6 pt, Mixed case)

**Symbol Samples**



New York Marble Cemetery

**Cemetery / buddhism (point)**



Symbol Graphic

Symbol Placement Instructions: Origin: Center of symbol

Symbol Type: Simple

Component Ref #: P00272      Component Type: Point - Shape      Color Token: Black  
 Description: Cemetery/tomb Buddhism  
[Parameters:](#)  
 Note: See Annex H for detailed drawing instructions.

**Symbol Rules**

Reference #: Description: Criteria:  
**PS-04080**    **Cemetery / buddhism (point)**      Religious Designation [REL] = Buddhism [1]

**Label Rules**

Label Placement Rules (see Annex J): LP-3505, LP-9999

Reference #: Description: Criteria:  
**PL-04080\_1**    **Cemetery / buddhism (point)**      N/A

Label String: [Name]  
 Characteristics: 1  
 1 (Black, Condensed, 6 pt, Mixed case)

**Symbol Samples**

## Cemetery / christian (point)



Symbol Graphic

Symbol Placement Instructions: Origin: Center of symbol

Symbol Type: Simple

Component Ref #: P00253      Component Type: Point - Shape      Color Token: Black  
 Description: Cemetery/tomb Christian  
[Parameters:](#)  
 Note: See Annex H for detailed drawing instructions.

### Symbol Rules

Reference #:	Description:	Criteria:
<b>PS-04079</b>	<b>Cemetery / christian (point)</b>	Religious Designation [REL] = Christian [4]

### Label Rules

Label Placement Rules (see Annex J): LP-3505, LP-9999

Reference #:	Description:	Criteria:
<b>PL-04079_1</b>	<b>Cemetery / christian (point)</b>	N/A

Label String: [Name]  
 Characteristics: 1  
 1 (Black, Condensed, 6 pt, Mixed case)

### Symbol Samples



Holy Cross Cemetery

## Cemetery / islam (point)



Symbol Graphic

Symbol Placement Instructions: Origin: Center of symbol

Symbol Type: Simple

Component Ref #: P00254      Component Type: Point - Shape      Color Token: Black  
 Description: Cemetery/tomb Islam  
[Parameters:](#)  
 Note: See Annex H for detailed drawing instructions.

### Symbol Rules

Reference #:	Description:	Criteria:
<b>PS-04081</b>	<b>Cemetery / islam (point)</b>	Religious Designation [REL] = Islam [2]

### Label Rules

Label Placement Rules (see Annex J): LP-3505, LP-9999

Reference #:	Description:	Criteria:
<b>PL-04081_1</b>	<b>Cemetery / islam (point)</b>	N/A

Label String: [Name]  
 Characteristics: 1  
 1 (Black, Condensed, 6 pt, Mixed case)

Symbol Samples



Dar-us-Salaam

**Cemetery / judaism (point)**



Symbol Graphic

Symbol Placement Instructions: Origin: Center of symbol  
 Symbol Type: Simple

Component Ref #: P00255      Component Type: Point - Shape      Color Token: Black  
 Description: Cemetery/tomb Judaism  
 Parameters:  
 Note: See Annex H for detailed drawing instructions.

Symbol Rules

Reference #: Description: Criteria:  
**PS-04082** Cemetery / judaism (point) Religious Designation [REL] = Judaism [5]

Label Rules

Label Placement Rules (see Annex J): LP-3505, LP-9999

Reference #: Description: Criteria:  
**PL-04082\_1** Cemetery / judaism (point) N/A

Label String: [Name]  
 Characteristics: 1  
 1 (Black, Condensed, 6 pt, Mixed case)

Symbol Samples



Siver Lake Cemetery

**Checkpoint (AH070)**

**Checkpoint / all (point)**



Symbol Graphic

Symbol Placement Instructions: Origin: Center of symbol  
 Symbol Type: Simple

Component Ref #: P00132      Component Type: Point - Shape      Color Token: Black  
 Description: Building checkpoint  
 Parameters:  
 Note: See Annex H for detailed drawing instructions.

Symbol Rules

Reference #:	Description:	Criteria:
PS-04033	Checkpoint / all (point)	All

Label Rules

Label Placement Rules (see Annex J): LP-3505, LP-9999

Reference #:	Description:	Criteria:
PL-04033_1	Checkpoint / all (point)	N/A

Label String: [Name]  
 Characteristics: 1  
 1 (Black, Condensed, 6 pt, Mixed case)

Symbol Samples



Circular Irrigation System (AJ010)

Generalization Rules (see Annex J): GA-9999

Circular Irrigation System / all (area)

Circular irrigation system	Symbol Placement Instructions:	Text label only. No graphic parameters
	Symbol Type:	Simple
Symbol Graphic		

Symbol Rules

Reference #:	Description:	Criteria:
PS-04303	Circular Irrigation System / all (area)	All

Label Rules

Label Placement Rules (see Annex J): LP-3506

Reference #:	Description:	Criteria:
PL-04303_1	Circular Irrigation System / all (area)	N/A

Label String: "Circular irrigation system"  
 Characteristics: 1  
 1 (Black, Condensed, 6 pt, Mixed case)

Symbol Samples

Circular irrigation system

Cistern (BI010)

Cistern / all (point)



Symbol Graphic

Symbol Placement Instructions: Origin: Center of symbol

Symbol Type: Simple

Component Ref #: P00007      Component Type: Point - Simple      Color Token: Cyan  
 Description: Cyan filled square with all sides 0.8mm  
Parameters:  
 Length: 0.8mm  
 Note: The component is a square and is filled with the solid color.

Symbol Rules

Reference #: Description: Criteria:  
**PS-04052**    **Cistern / all (point)**      All

Symbol Samples



**Cleared Way (EC040)**

Generalization Rules (see Annex J): GA-9999

**Cleared Way / all (area)**

{NO SYMBOL}

Symbol Graphic

Symbol Placement Instructions: The symbol is applied to the geometry of the feature.

Symbol Type: Simple

Note: The symbol is a mask of the Thicket (EB020) and Wood (EC030) feature symbols.

Symbol Rules

Reference #: Description: Criteria:  
**PS-04853**    **Cleared Way / all (area)**      All

Symbol Samples

{NO SYMBOL}



**Communication Line (AT060)**

Generalization Rules (see Annex J): GA-9999, GC-9988

**Communication Line / non-obstruction (line)**



Symbol Graphic

**Symbol Placement Instructions:** The symbol is applied to the geometry of the feature.  
**Symbol Type:** Complex  
**Repeating Point and Interval:** Component P00287 has an initial offset of 3.5mm; after that 7.0mm.  
**Note:** Component P00287 is centered along Component L00445.

<b>Component Ref #:</b>	L00445	<b>Component Type:</b>	Line - Simple	<b>Color Token:</b>	Blue072
<b>Description:</b>	Blue072 0.25mm Solid Line				
<b>Parameters:</b>					
<b>Line Weight:</b>	0.25mm				
<b>Component Ref #:</b>	P00287	<b>Component Type:</b>	Point - Simple	<b>Color Token:</b>	Blue072
<b>Description:</b>	Blue072 0.8mm diameter open circle				
<b>Parameters:</b>					
<b>Diameter:</b>	0.8mm				
<b>Line Weight:</b>	0.25mm				
<b>Note:</b>	The component is an open circle.				

**Symbol Rules**

<b>Reference #:</b>	<b>Description:</b>	<b>Criteria:</b>
PS-04729	Communication Line / non-obstruction (line)	Height Above Surface Level [HGT] < 46

**Symbol Samples**



**Communication Line / obstruction (line)**



Symbol Graphic

**Symbol Placement Instructions:** The symbol is applied to the geometry of the feature.  
**Symbol Type:** Complex

<b>Component Ref #:</b>	L00006	<b>Component Type:</b>	Line - Simple	<b>Color Token:</b>	Blue072
<b>Description:</b>	Blue072 0.73mm Solid Line				
<b>Parameters:</b>					
<b>Line Weight:</b>	0.73mm				

**Symbol Rules**

<b>Reference #:</b>	<b>Description:</b>	<b>Criteria:</b>
PS-04730	Communication Line / obstruction (line)	Height Above Surface Level [HGT] >= 46

**Label Rules**

Label Placement Rules (see Annex J): LP-9991

<b>Reference #:</b>	<b>Description:</b>	<b>Criteria:</b>
PL-04730_1	Communication Line / obstruction (line)	N/A

**Label String:** "Communication line"  
 [Highest Elevation]  
 ("[Height Above Surface Level]")  
**Characteristics:** 15  
 46  
 95, 95, 95

15 (Blue072, Condensed, 6 pt, Mixed case)  
 46 (Blue072, Condensed, Bold, 6 pt, Lower case)  
 95 (Blue072, Condensed, 6 pt, Lower case)

Symbol Samples

Communication line  
 242  
 (72)

**Communication Station (AT050)**

Generalization Rules (see Annex J): GA-9999, GC-9983, GC-9999

**Communication Station / non-obstruction (area)**



Symbol Graphic

Symbol Placement Instructions: The symbol is applied to the geometry of the feature.

Symbol Type: Simple

Component Ref #:	L00210	Component Type:	Line - Styled	Color Token:	Black
Description:	Black 0.1mm Dashed line (0.1mm wt, 1.0mm dash, 0.5mm gap)				
<u>Parameters:</u>					
Line Weight:	0.1mm	Dash Length:	1.0mm	Dash Spacing:	0.5mm

Symbol Rules

Reference #:	Description:	Criteria:
PS-04726	Communication Station / non-obstruction (area)	Height Above Surface Level [HGT] < 46

Label Rules

Label Placement Rules (see Annex J): LP-3506, LP-9950, LP-9999

Reference #:	Description:	Criteria:
PL-04726_1	Communication Station / intact (area)	Condition of Facility [FUN] = (Fully Functional [6], Unknown [0])
	Label String: "Communication station"	
	Characteristics: 1 1 (Black, Condensed, 6 pt, Mixed case)	
PL-04726_2	Communication Station / not intact (area)	Condition of Facility [FUN] = (Abandoned [2], Damaged [13], Destroyed [3], Dismantled [4], Under Construction [1])
	Label String: "Communication station" "["[Condition of Facility]"	
	Characteristics: 1, 22, 22, 22 1 (Black, Condensed, 6 pt, Mixed case) 22 (Black, Condensed, 6 pt, Lower case)	

Symbol Samples



**Communication Station / non-obstruction / intact (point)**





Symbol Graphic

Symbol Placement Instructions: Origin: Center of symbol

Symbol Type: Simple

Component Ref #: P00006      Component Type: Point - Simple      Color Token: Black  
 Description: Black filled square with all sides 0.8mm  
Parameters:  
 Length: 0.8mm  
 Note: The component is a square and is filled with the solid color.

Symbol Rules

Reference #: Description: Criteria:  
**PS-04727**    **Communication Station / non-obstruction / intact (point)**    Height Above Surface Level [HGT] < 46  
 AND    Condition of Facility [FUN] = (Fully Functional [6], Unknown [0])

Label Rules

Label Placement Rules (see Annex J): LP-3505

Reference #: Description: Criteria:  
**PL-04727\_1**    **Communication Station / intact (point)**    N/A

Label String: "Communication station"  
 Characteristics: 1  
 1 (Black, Condensed, 6 pt, Mixed case)

Symbol Samples

Communication station

**Communication Station / non-obstruction / not intact (point)**



Symbol Graphic

Symbol Placement Instructions: Origin: Center of symbol

Symbol Type: Simple

Component Ref #: P00173      Component Type: Point - Shape      Color Token: Black/Black-12  
 Description: Not intact square 0.8mm  
Parameters:  
 Note: See Annex H for detailed drawing instructions.

Symbol Rules

Reference #: Description: Criteria:  
**PS-04728**    **Communication Station / non-obstruction / not intact (point)**    Height Above Surface Level [HGT] < 46  
 AND    Condition of Facility [FUN] = (Abandoned [2], Damaged [13], Destroyed [3], Dismantled [4], Under Construction [1])

Symbol Samples

Communication station

## Conveyor (AF020)

Generalization Rules (see Annex J): GA-9999

### Conveyor / non-obstruction (line)

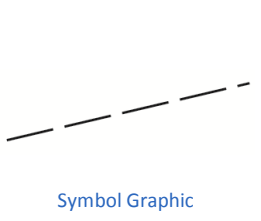

Symbol Placement Instructions: The symbol is applied to the geometry of the feature.

Symbol Type: Simple

Component Ref #:	L00032	Component Type:	Line - Styled	Color Token:	Black
Description:	Black 0.2mm Dashed Line (0.2mm wt, 2.0mm dash, 0.5mm gap)				
<u>Parameters:</u>					
Line Weight:	0.2mm	Dash Length:	2.0mm	Dash Spacing:	0.5mm

#### Symbol Rules

Reference #:	Description:	Criteria:
PS-04034	Conveyor / non-obstruction (line)	Height Above Surface Level [HGT] < 46

#### Label Rules

Label Placement Rules (see Annex J): LP-3630

Reference #:	Description:	Criteria:
PL-04034_1	Conveyor / non-obstruction (line)	N/A

Label String: "Conveyor"  
 Characteristics: 1  
 1 (Black, Condensed, 6 pt, Mixed case)

#### Symbol Samples

Conveyor

### Conveyor / obstruction (line)

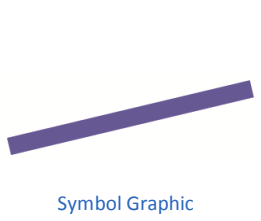

Symbol Placement Instructions: The symbol is applied to the geometry of the feature.

Symbol Type: Simple

Component Ref #:	L00006	Component Type:	Line - Simple	Color Token:	Blue072
Description:	Blue072 0.73mm Solid Line				
<u>Parameters:</u>					
Line Weight:	0.73mm				

#### Symbol Rules

Reference #:	Description:	Criteria:
PS-04886	Conveyor / obstruction (line)	Height Above Surface Level [HGT] >= 46

#### Label Rules

Label Placement Rules (see Annex J): LP-9991

Reference #: **PL-04886\_1** Description: **Conveyor / obstruction (line)** Criteria: N/A

Label String: "Conveyor"  
 [Highest Elevation]  
 ("[Height Above Surface Level]")  
 Characteristics: 15  
 46  
 95, 95, 95  
 15 (Blue072, Condensed, 6 pt, Mixed case)  
 46 (Blue072, Condensed, Bold, 6 pt, Lower case)

Symbol Samples

Conveyor  
243  
(71)

Conveyor / non-obstruction (point)



Symbol Graphic

Symbol Placement Instructions: Origin: Center of symbol  
 Symbol Type: Simple

Component Ref #: P00010 Component Type: Point - Shape Color Token: Black  
 Description: Located object  
 Parameters:  
 Note: See Annex H for detailed drawing instructions.

Symbol Rules

Reference #: **PS-04887** Description: **Conveyor / non-obstruction (point)** Criteria: Height Above Surface Level [HGT] < 46

Label Rules

Label Placement Rules (see Annex J): LP-3505

Reference #: **PL-04887\_1** Description: **Conveyor / non-obstruction (point)** Criteria: N/A

Label String: "Conveyor"  
 Characteristics: 1  
 1 (Black, Condensed, 6 pt, Mixed case)

Symbol Samples

Conveyor

Conveyor / obstruction (point)



Symbol Graphic

Symbol Placement Instructions: Origin: Center of open circle  
 Symbol Type: Simple

Component Ref #: P00113      Component Type: Point - Shape      Color Token: Blue072  
 Description: Vertical obstruction linear  
 Parameters:  
 Note: See Annex H for detailed drawing instructions.

**Symbol Rules**

Reference #: PS-04888      Description: Conveyor / obstruction (point)      Criteria: Height Above Surface Level [HGT] >= 46

**Label Rules**

Label Placement Rules (see Annex J): LP-9992

Reference #: PL-04888\_1      Description: Conveyor / obstruction (point)      Criteria: N/A

Label String: "Conveyor"  
 [Highest Elevation]  
 ("[Height Above Surface Level]")  
 Characteristics: 15  
 46  
 95, 95, 95  
 15 (Blue072, Condensed, 6 pt, Mixed case)  
 46 (Blue072, Condensed, Bold, 6 pt, Lower case)

**Symbol Samples**



**Crane (AF040)**

**Crane / non-obstruction (point)**



Symbol Graphic

Symbol Placement Instructions: Origin: Center of symbol  
 Symbol Type: Simple

Component Ref #: P00131      Component Type: Point - Shape      Color Token: Black  
 Description: Crane  
 Parameters:  
 Note: See Annex H for detailed drawing instructions.

**Symbol Rules**

Reference #: PS-04038      Description: Crane / non-obstruction (point)      Criteria: Height Above Surface Level [HGT] < 46

**Symbol Samples**



Shown with Tidal Water:



**Crevasse (BJ031)**

Generalization Rules (see Annex J): GA-9999

**Crevasse / all (area)**



Symbol Graphic

Symbol Placement Instructions: The symbol is applied to the geometry of the feature.

Symbol Type: Complex

Note: Component L00016 is applied to the perimeter and is filled with Component A00062.

Component Ref #:	A00062	Component Type:	Area - Pattern	Color Token:	Cyan
Description:	Cyan Diagonal Line Fill				
<u>Parameters:</u>					
Area Pattern:	LP-3, see Annex I				

Component Ref #:	L00016	Component Type:	Line - Simple	Color Token:	Cyan
Description:	Cyan 0.3mm Solid Line				
<u>Parameters:</u>					
Line Weight:	0.3mm				

Symbol Rules

Reference #:	Description:	Criteria:
PS-04496	Crevasse / all (area)	All

Label Rules

Label Placement Rules (see Annex J): LP-0050, LP-3505

Reference #:	Description:	Criteria:
PL-04496_1	Crevasse / all (area)	N/A

Label String: "Crevasse"  
 Characteristics: 32  
 32 (Cyan, Condensed, Italic, 6-9 pt, Mixed case)

Symbol Samples



Crevasse / all (line)



Symbol Graphic

Symbol Placement Instructions: The symbol is applied to the geometry of the feature.

Symbol Type: Simple

Component Ref #:	L00248	Component Type:	Line - Simple	Color Token:	Cyan
Description:	Cyan 0.25mm Solid Line				
<u>Parameters:</u>					
Line Weight:	0.25mm				

Symbol Rules

Reference #:	Description:	Criteria:
PS-04497	Crevasse / all (line)	All

Label Rules

Label Placement Rules (see Annex J): LP-3630

Reference #:	Description:	Criteria:
PL-04497_1	Crevasse / all (line)	N/A

Label String: "Crevasse"  
 Characteristics: 16

Symbol Samples

*Crevasse*

**Crevice (DB061)**

Generalization Rules (see Annex J): GA-9999

**Crevice / all (area)**

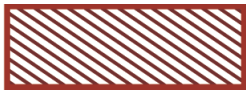

Symbol Graphic

Symbol Placement Instructions: The symbol is applied to the geometry of the feature.

Symbol Type: Complex

Note: Component L00105 is applied to the perimeter and is filled with Component A00061.

Component Ref #:	A00061	Component Type:	Area - Pattern	Color Token:	Dk-Brown1815
Description:	Dk-Brown1815 Diagonal Line Fill				
Parameters:					
Area Pattern:	LP-3, see Annex I				

Component Ref #:	L00105	Component Type:	Line - Simple	Color Token:	Dk-Brown1815
Description:	Dk-Brown1815 0.3mm Solid Line				
Parameters:					
Line Weight:	0.3mm				

Symbol Rules

Reference #:	Description:	Criteria:
PS-04498	Crevice / all (area)	All

Label Rules

Label Placement Rules (see Annex J): LP-0050, LP-3505

Reference #:	Description:	Criteria:
PL-04498_1	Crevice / all (area)	N/A

Label String: "Crevice"  
 Characteristics: 6  
 6 (Black, Condensed, Italic, 6-9 pt, Mixed case)

Symbol Samples

*Crevice*



Symbol Graphic

Symbol Placement Instructions: The symbol is applied to the geometry of the feature.

Symbol Type: Simple

**Crevice / all (line)**



Component Ref #: L00024      Component Type: Line - Simple      Color Token: Dk-Brown1815  
 Description: Dk-Brown1815 0.25mm Solid Line  
[Parameters:](#)  
 Line Weight: 0.25mm

**Symbol Rules**

Reference #: Description: Criteria:  
**PS-04499**    **Crevice / all (line)**      All

**Label Rules**

Label Placement Rules (see Annex J): LP-3630

Reference #: Description: Criteria:  
**PL-04499\_1**    **Crevice / all (line)**      N/A

Label String: "Crevice"  
 Characteristics: 5  
 5 (Black, Condensed, Italic, 6 pt, Mixed case)

**Symbol Samples**

*Crevice*

---

**Crop Land (EA010)**

Generalization Rules (see Annex J): GA-9999

**Crop Land / dry crops (area)**

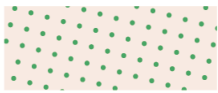

Symbol Graphic

Symbol Placement Instructions: The symbol is applied to the geometry of the feature.

Symbol Type: Compound

Note: Components A00060 and A00118 are combined into one symbol. Display level from bottom to top: Component A00060; Component A00118. The entire pattern is rotated to 30 degrees.

Component Ref #: A00060      Component Type: Area - Fill      Color Token: Dk-Brown1815-07  
 Description: Dk-Brown1815-07 area fill  
[Parameters:](#)  
 Screen Angle: 45 degrees  
 Screen Percent: 7%

Component Ref #: A00118      Component Type: Area - Pattern      Color Token: Green362  
 Description: Green362 Cropland dot fill  
[Parameters:](#)  
 Area Pattern: No existing MIL\_STD\_2410 area pattern. See Annex I for detailed drawing instructions.

**Symbol Rules**

Reference #: Description: Criteria:  
**PS-04304**    **Crop Land / dry crops (area)**      Farming Method [FMM] = (Fallow [1], Other [999], Permanent [3], Slash and Burn [4], Unknown [0])

**Label Rules**

Label Placement Rules (see Annex J): LP-3506

Reference #: Description: Criteria:  
**PL-04304\_1**    **Crop Land / dry crops (area)**      Farming Pattern [FFP] = Terraced [3]

Label String: "Terraces"  
 Characteristics: 1  
 1 (Black, Condensed, 6 pt, Mixed case)

**Symbol Samples**



## Crop Land / irrigated crops (area)

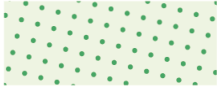

Symbol Graphic

**Symbol Placement Instructions:** The symbol is applied to the geometry of the feature.

**Symbol Type:** Compound

**Note:** Components A00127 and A00118 are combined into one symbol. Display level from bottom to top: Component A00127; Component A00118. The entire pattern is rotated to 30 degrees.

<b>Component Ref #:</b>	A00127	<b>Component Type:</b>	Area - Fill	<b>Color Token:</b>	Green362-07
<b>Description:</b>	Green362-07 area fill				
<b>Parameters:</b>					
<b>Screen Angle:</b>	45 degrees				
<b>Screen Percent:</b>	7%				

<b>Component Ref #:</b>	A00118	<b>Component Type:</b>	Area - Pattern	<b>Color Token:</b>	Green362
<b>Description:</b>	Green362 Cropland dot fill				
<b>Parameters:</b>					
<b>Area Pattern:</b>	No existing MIL_STD_2410 area pattern. See Annex I for detailed drawing instructions.				

### Symbol Rules

<b>Reference #:</b>	<b>Description:</b>	<b>Criteria:</b>
PS-04019	Crop Land / irrigated crops (area)	Farming Method [FMM] = Permanent Irrigation [5]

### Label Rules

Label Placement Rules (see Annex J): LP-3506

<b>Reference #:</b>	<b>Description:</b>	<b>Criteria:</b>
PL-04019_1	Crop Land / irrigated crops (area)	Farming Pattern [FFP] = Terraced [3]

**Label String:** "Terraces"  
**Characteristics:** 1  
 1 (Black, Condensed, 6 pt, Mixed case)

### Symbol Samples



## Culvert (AQ065)

### Culvert / all (point)



Symbol Graphic

**Symbol Placement Instructions:** Origin: Center of symbol

**Symbol Type:** Simple

**Note:** The apex of the "V"s are aligned to each side of the corresponding transportation feature.

<b>Component Ref #:</b>	P00106	<b>Component Type:</b>	Point - Shape	<b>Color Token:</b>	Black
<b>Description:</b>	Culvert double "V"				
<b>Parameters:</b>					
<b>Note:</b>	See Annex H for detailed drawing instructions.				



Symbol Rules

Reference #: PS-04705 Description: Culvert / all (point) Criteria: All

Symbol Samples



Cut (DB070)

Generalization Rules (see Annex J): GA-9999

Cut / all (line)

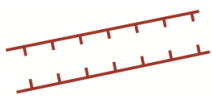

Symbol Graphic

Symbol Placement Instructions: The symbol is applied to the geometry of the feature.  
 Symbol Type: Complex  
 Repeating Point and Interval: Component P00174 has an initial offset of 0.75mm; after that 1.5mm.  
 Note: Component P00174 is perpendicular to and on the inward side of Component L00241.

Component Ref #: L00241 Component Type: Line - Simple Color Token: Dk-Brown1815  
 Description: Two parallel Dk-Brown1815 0.15mm Solid Lines  
 Parameters:  
 Line Weight: 0.15mm  
 Note: Spacing is variable based on the width of the overpassing feature. The minimum space between each line and the linear portion of the overpassing feature shall be 0.2 mm.

Component Ref #: P00174 Component Type: Point - Simple Color Token: Dk-Brown1815  
 Description: Dk-Brown1815 0.5mm length line with 0.15mm lineweight  
 Parameters:  
 Line Weight: 0.15mm  
 Length: 0.5mm

Symbol Rules

Reference #: PS-04243 Description: Cut / all (line) Criteria: All

Symbol Samples



Cut Line (DB071)

Generalization Rules (see Annex J): GA-9999

Cut Line / all (line)



Symbol Graphic

Symbol Placement Instructions: The symbol is applied to the geometry of the feature.  
 Symbol Type: Complex  
 Repeating Point and Interval: Component P00174 has an initial offset of 0.75mm; after that 1.5mm.  
 Note: Component P00174 is perpendicular to and on the downhill side of Component L00240.

Component Ref #: L00240      Component Type: Line - Simple      Color Token: Dk-Brown1815  
 Description: Dk-Brown1815 0.15mm Solid Line  
[Parameters:](#)  
 Line Weight: 0.15mm

Component Ref #: P00174      Component Type: Point - Simple      Color Token: Dk-Brown1815  
 Description: Dk-Brown1815 0.5mm length line with 0.15mm lineweight  
[Parameters:](#)  
 Line Weight: 0.15mm  
 Length: 0.5mm

Symbol Rules

Reference #:	Description:	Criteria:
PS-04244	Cut Line / all (line)	All

Symbol Samples



Dam (BI020)

Generalization Rules (see Annex J): GA-9999, GC-9995, GC-9997

Dam / hard (area)



Symbol Graphic

Symbol Placement Instructions: The symbol is applied to the geometry of the feature.  
 Symbol Type: Simple

Component Ref #: L00013      Component Type: Line - Simple      Color Token: Black  
 Description: Black 0.4mm Solid Line  
[Parameters:](#)  
 Line Weight: 0.4mm

Symbol Rules

Reference #:	Description:	Criteria:
PS-04214	Dam / hard (area)	Structural Material Type [MCC] = (Asphalt [5], Brick [9], Concrete [21], Masonry [62], Metal [64], Prestressed Concrete [77], Reinforced Concrete [83])

Label Rules

Label Placement Rules (see Annex J): LP-3505, LP-4813, LP-9950, LP-9999

Reference #:	Description:	Criteria:
PL-04214_1	Dam / hard / intact (area)	Condition of Facility [FUN] = (Fully Functional [6], Unknown [0])

Label String: [Name] "Dam"  
 Characteristics: 1, 1  
 1 (Black, Condensed, 6 pt, Mixed case)

Reference #:	Description:	Criteria:
PL-04214_2	Dam / hard / not intact (area)	Condition of Facility [FUN] = (Abandoned [2], Damaged [13], Destroyed [3], Dismantled [4], Under Construction [1])

Label String: [Name] "Dam" "["[Condition of Facility]""]"  
 Characteristics: 1, 1, 22, 22, 22  
 1 (Black, Condensed, 6 pt, Mixed case)  
 22 (Black, Condensed, 6 pt, Lower case)

Symbol Samples



### Dam / loose (area)

**Symbol Placement Instructions:** The symbol is applied to the geometry of the feature.

**Symbol Type:** Simple



Symbol Graphic

**Component Ref #:** L00195      **Component Type:** Line - Simple      **Color Token:** Dk-Brown1815  
**Description:** Dk-Brown1815 0.4mm Solid Line  
[Parameters:](#)  
**Line Weight:** 0.4mm

### Symbol Rules

<b>Reference #:</b> PS-04215	<b>Description:</b> Dam / loose (area)	<b>Criteria:</b> Structural Material Type [MCC] = (Clay [16], Composition [20], Conglomerate [22], Gravel [46], Macadam [57], Other [999], Part Metal [72], Pebbles [73], Rock [84], Rubble [86], Sand [88], Soil [104], Stone [108], Unknown [0], Wood [117])
------------------------------	--	--

### Label Rules

**Label Placement Rules (see Annex J):** LP-3505, LP-4813, LP-9950, LP-9999

<b>Reference #:</b> PL-04215_1	<b>Description:</b> Dam / loose / intact (area)	<b>Criteria:</b> Condition of Facility [FUN] = (Fully Functional [6], Unknown [0])
--------------------------------	---	--

**Label String:** [Name] "Dam"  
**Characteristics:** 1, 1  
 1 (Black, Condensed, 6 pt, Mixed case)

<b>Reference #:</b> PL-04215_2	<b>Description:</b> Dam / loose / not intact (area)	<b>Criteria:</b> Condition of Facility [FUN] = (Abandoned [2], Damaged [13], Destroyed [3], Dismantled [4], Under Construction [1])
--------------------------------	---	---

**Label String:** [Name] "Dam" "["[Condition of Facility]""]"  
**Characteristics:** 1, 1, 22, 22, 22  
 1 (Black, Condensed, 6 pt, Mixed case)  
 22 (Black, Condensed, 6 pt, Lower case)

### Symbol Samples



### Dam / hard / transportation (line)

**Symbol Placement Instructions:** The symbol is applied to the geometry of the feature.

**Symbol Type:** Simple



Symbol Graphic

**Component Ref #:** L00019      **Component Type:** Line - Simple      **Color Token:** Black  
**Description:** Two parallel Black 0.3mm Solid Lines  
[Parameters:](#)  
**Line Weight:** 0.3mm

Note: Spacing is variable based on the width of the overpassing feature.

### Symbol Rules

<b>Reference #:</b>	<b>Description:</b>	<b>Criteria:</b>
<b>PS-04217</b>	<b>Dam / hard / transportation (line)</b>	Structural Material Type [MCC] = (Asphalt [5], Brick [9], Concrete [21], Masonry [62], Metal [64], Prestressed Concrete [77], Reinforced Concrete [83])
	AND	Transportation System Type [TRS] = (Aeronautical [1], Aqueduct [2], Bus [4], Canal [5], Maritime [7], Pipeline [10], Railway [12], Road [13])

### Label Rules

Label Placement Rules (see Annex J): LP-3505, LP-4813, LP-9950, LP-9999

<b>Reference #:</b>	<b>Description:</b>	<b>Criteria:</b>
<b>PL-04217_1</b>	<b>Dam / hard / transportation / intact (line)</b>	Condition of Facility [FUN] = (Fully Functional [6], Unknown [0])
	Label String: [Name] "Dam"	
	Characteristics: 1, 1 1 (Black, Condensed, 6 pt, Mixed case)	
<b>PL-04217_2</b>		Condition of Facility [FUN] = (Abandoned [2], Damaged [13], Destroyed [3], Dismantled [4], Under Construction [1])
	Label String: [Name] "Dam" "["[Condition of Facility]"	
	Characteristics: 1, 1, 22, 22, 22 1 (Black, Condensed, 6 pt, Mixed case) 22 (Black, Condensed, 6 pt, Lower case)	

### Symbol Samples

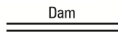

Shown with Road and River:

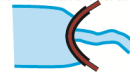

### Dam / loose / transportation (line)



Symbol Graphic

Symbol Placement Instructions: The symbol is applied to the geometry of the feature.  
Symbol Type: Simple

<b>Component Ref #:</b>	L00247	<b>Component Type:</b>	Line - Simple	<b>Color Token:</b>	Dk-Brown1815
<b>Description:</b>	Two parallel Dk-Brown1815 0.3mm Solid Lines				
<b>Parameters:</b>					
<b>Line Weight:</b>	0.3mm				
<b>Note:</b>	Spacing is variable based on the width of the overpassing feature.				

### Symbol Rules

<b>Reference #:</b>	<b>Description:</b>	<b>Criteria:</b>
<b>PS-04502</b>	<b>Dam / loose / transportation (line)</b>	Structural Material Type [MCC] = (Clay [16], Composition [20], Conglomerate [22], Gravel [46], Macadam [57], Other [999], Part Metal [72], Pebbles [73], Rock [84], Rubble [86], Sand [88], Soil [104], Stone [108], Unknown [0], Wood [117])
	AND	Transportation System Type [TRS] = (Aeronautical [1], Aqueduct [2], Bus [4], Canal [5], Maritime [7], Pipeline [10], Railway [12], Road [13])

### Label Rules

Label Placement Rules (see Annex J): LP-3505, LP-4813, LP-9950, LP-9999

<b>Reference #:</b>	<b>Description:</b>	<b>Criteria:</b>
<b>PL-04502_1</b>	<b>Dam / loose / transportation / intact (line)</b>	Condition of Facility [FUN] = (Fully Functional [6], Unknown [0])
	Label String: [Name] "Dam"	
	Characteristics: 1, 1 1 (Black, Condensed, 6 pt, Mixed case)	

**PL-04502\_2 Dam / loose / transportation / not intact (line)**

Condition of Facility [FUN] = (Abandoned [2], Damaged [13], Destroyed [3], Dismantled [4], Under Construction [1])

**Label String:** [Name] "Dam" "["[Condition of Facility]""]  
**Characteristics:** 1, 1, 22, 22, 22  
 1 (Black, Condensed, 6 pt, Mixed case)  
 22 (Black, Condensed, 6 pt, Lower case)

**Symbol Samples**



**Dam / hard / no transportation (line)**



Symbol Graphic

**Symbol Placement Instructions:** The symbol is applied to the geometry of the feature.  
**Symbol Type:** Simple

**Component Ref #:** L00013      **Component Type:** Line - Simple      **Color Token:** Black  
**Description:** Black 0.4mm Solid Line  
Parameters:  
**Line Weight:** 0.4mm

**Symbol Rules**

**Reference #:** **Description:** **Criteria:**  
**PS-04216 Dam / hard / no transportation (line)** Structural Material Type [MCC] = (Asphalt [5], Brick [9], Concrete [21], Masonry [62], Metal [64], Prestressed Concrete [77], Reinforced Concrete [83])  
 AND Transportation System Type [TRS] = (Not Applicable [998], Other [999], Pedestrian [9], Unknown [0])

**Label Rules**

**Label Placement Rules (see Annex J):** LP-3505, LP-9999

**Reference #:** **Description:** **Criteria:**  
**PL-04216\_1 Dam / hard / no transportation (line)** N/A

**Label String:** [Name]  
**Characteristics:** 1  
 1 (Black, Condensed, 6 pt, Mixed case)

**Symbol Samples**



**Dam / loose / no transportation (line)**



Symbol Graphic

**Symbol Placement Instructions:** The symbol is applied to the geometry of the feature.  
**Symbol Type:** Simple

Component Ref #: L00195      Component Type: Line - Simple      Color Token: Dk-Brown1815  
 Description: Dk-Brown1815 0.4mm Solid Line  
[Parameters:](#)  
 Line Weight: 0.4mm

**Symbol Rules**

Reference #:	Description:	Criteria:
<b>PS-04429</b>	<b>Dam / loose / no transportation (line)</b>	Structural Material Type [MCC] = (Clay [16], Composition [20], Conglomerate [22], Gravel [46], Macadam [57], Other [999], Part Metal [72], Pebbles [73], Rock [84], Rubble [86], Sand [88], Soil [104], Stone [108], Unknown [0], Wood [117])
	AND	Transportation System Type [TRS] = (Not Applicable [998], Other [999], Pedestrian [9], Unknown [0])

**Label Rules**

Label Placement Rules (see Annex J): LP-3505, LP-9999

Reference #:	Description:	Criteria:
<b>PL-04429_1</b>	<b>Dam / loose / no transportation (line)</b>	N/A
	Label String: [Name]	
	Characteristics: 1	
	1 (Black, Condensed, 6 pt, Mixed case)	

**Symbol Samples**



**Dam / hard (point)**



Symbol Placement Instructions: Origin: Center of symbol  
 Symbol Type: Simple  
 Note: The symbol shall be aligned perpendicular to the associated hydrographic feature.

Component Ref #: P00269      Component Type: Point - Simple      Color Token: Black  
 Description: Black 1.5mm length line with a 0.4mm lineweight  
[Parameters:](#)  
 Line Weight: 0.4mm  
 Length: 1.5mm

**Symbol Rules**

Reference #:	Description:	Criteria:
<b>PS-04218</b>	<b>Dam / hard (point)</b>	Structural Material Type [MCC] = (Asphalt [5], Brick [9], Concrete [21], Masonry [62], Metal [64], Prestressed Concrete [77], Reinforced Concrete [83])

**Symbol Samples**



**Dam / loose (point)**

Symbol Placement Instructions: Origin: Center of symbol

Symbol Type: Simple



Symbol Graphic

Note: The symbol shall be aligned perpendicular to the associated hydrographic feature.

Component Ref #:	P00270	Component Type:	Point - Simple	Color Token:	Dk-Brown1815
Description:	Dk-Brown1815 1.5mm length line with a 0.4mm lineweight				
<u>Parameters:</u>					
Line Weight:	0.4mm				
Length:	1.5mm				

### Symbol Rules

Reference #:	Description:	Criteria:
PS-04430	Dam / loose (point)	Structural Material Type [MCC] = (Clay [16], Composition [20], Conglomerate [22], Gravel [46], Macadam [57], Other [999], Part Metal [72], Pebbles [73], Rock [84], Rubble [86], Sand [88], Soil [104], Stone [108], Unknown [0], Wood [117])

### Symbol Samples

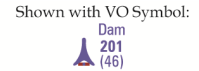

## Dish Aerial (AT010)

### Dish Aerial / non-obstruction (point)

Symbol Placement Instructions: Origin: Center of open circle

Symbol Type: Simple



Symbol Graphic

Component Ref #:	P00133	Component Type:	Point - Shape	Color Token:	Black
Description:	Dish aerial				
<u>Parameters:</u>					
Note:	See Annex H for detailed drawing instructions.				

### Symbol Rules

Reference #:	Description:	Criteria:
PS-04152	Dish Aerial / non-obstruction (point)	Height Above Surface Level [HGT] < 46

### Symbol Samples



## Disposal Site (AB000)

Generalization Rules (see Annex J): GA-9999, GC-9983

### Disposal Site / non-obstruction (area)



Symbol Graphic

Symbol Placement Instructions: The symbol is applied to the geometry of the feature.

Symbol Type: Simple

Component Ref #:	L00210	Component Type:	Line - Styled	Color Token:	Black
Description:	Black 0.1mm Dashed line (0.1mm wt, 1.0mm dash, 0.5mm gap)				
<u>Parameters:</u>					
Line Weight:	0.1mm	Dash Length:	1.0mm	Dash Spacing:	0.5mm

Symbol Rules

Reference #:	Description:	Criteria:
PS-04278	Disposal Site / non-obstruction (area)	Height Above Surface Level [HGT] < 46

Label Rules

Label Placement Rules (see Annex J): LP-3506, LP-4813, LP-9999

Reference #:	Description:	Criteria:
PL-04278_1	Disposal Site / non-obstruction (area)	N/A

Label String: [Name] [By-product] "Disposal site"  
 Characteristics: 1, 1, 1  
 1 (Black, Condensed, 6 pt, Mixed case)

Symbol Samples

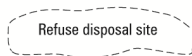

Ditch (BH030)

Generalization Rules (see Annex J): GA-9999

Ditch / perennial (area)



Symbol Graphic

Symbol Placement Instructions: The symbol is applied to the geometry of the feature.

Symbol Type: Complex

Note: Component L00015 is applied to the perimeter and is filled with Component A00007.

Component Ref #:	A00007	Component Type:	Area - Fill	Color Token:	Cyan-31
Description:	Cyan-31 area fill				
<u>Parameters:</u>					
Screen Angle:	45 degrees				
Screen Percent:	31%				

Component Ref #:	L00015	Component Type:	Line - Simple	Color Token:	Cyan
Description:	Cyan 0.2mm Solid Line				
<u>Parameters:</u>					
Line Weight:	0.2mm				

Symbol Rules

Reference #:	Description:	Criteria:
PS-04179	Ditch / perennial (area)	Hydrologic Persistence [HYP] = (Perennial [1], Unknown [0])

Label Rules

Label Placement Rules (see Annex J): LP-0062, LP-9997, LP-9999

Reference #:	Description:	Criteria:



**PL-04179\_1 Ditch / perennial (area)**

N/A

Label String: [Name]  
 Characteristics: 37  
 37 (Cyan, Condensed, Italic, 7-16 pt, Upper case)

**Symbol Samples**



**Ditch / intermittent, dry (area)**



Symbol Graphic

Symbol Placement Instructions: The symbol is applied to the geometry of the feature.

Symbol Type: Complex

Note: Component L00041 is applied to the perimeter and is filled with Component A00020.

Component Ref #:	A00020	Component Type:	Area - Pattern	Color Token:	Cyan
Description:	Cyan Dry Drainage Fill				
Parameters:	AP-95, see Annex I				

Component Ref #:	L00041	Component Type:	Line - Styled	Color Token:	Cyan	
Description:	Cyan 0.2mm Dashed Line (0.2mm wt, 2.0mm dash, 0.5mm gap)					
Parameters:	Line Weight:	0.2mm	Dash Length:	2.0mm	Dash Spacing:	0.5mm

**Symbol Rules**

Reference #:	Description:	Criteria:
PS-04180	Ditch / intermittent, dry (area)	Hydrologic Persistence [HYP] = (Dry [4], Intermittent [2])

**Label Rules**

Label Placement Rules (see Annex J): LP-0062, LP-9997, LP-9999

Reference #:	Description:	Criteria:
PL-04180_1	Ditch / intermittent, dry (area)	N/A

Label String: [Name]  
 Characteristics: 37  
 37 (Cyan, Condensed, Italic, 7-16 pt, Upper case)

**Symbol Samples**



**Ditch / perennial (line)**



Symbol Graphic

Symbol Placement Instructions: The symbol is applied to the geometry of the feature.

Symbol Type: Simple

Component Ref #: L00108      Component Type: Line - Simple      Color Token: Cyan  
 Description: Cyan 0.1mm Solid Line  
Parameters:  
 Line Weight: 0.1mm

**Symbol Rules**

Reference #: PS-04181      Description: Ditch / perennial (line)      Criteria: Hydrologic Persistence [HYP] = (Perennial [1], Unknown [0])

**Symbol Samples**



**Ditch / intermittent, dry (line)**

Symbol Placement Instructions: The symbol is applied to the geometry of the feature.  
 Symbol Type: Simple



Symbol Graphic

Component Ref #: L00246      Component Type: Line - Styled      Color Token: Cyan  
 Description: Cyan 0.1mm Dashed Line (0.1mm wt, 2.0mm dash, 0.5mm gap)  
Parameters:  
 Line Weight: 0.1mm      Dash Length: 2.0mm      Dash Spacing: 0.5mm

**Symbol Rules**

Reference #: PS-04182      Description: Ditch / intermittent, dry (line)      Criteria: Hydrologic Persistence [HYP] = (Dry [4], Intermittent [2])

**Symbol Samples**



**Dragon's Teeth (AL060)**

Generalization Rules (see Annex J): GA-9999

**Dragon's Teeth / all (area)**

Symbol Placement Instructions: The symbol is applied to the geometry of the feature.  
 Symbol Type: Complex  
 Repeating Point and Interval: Component P00175 is centered in the 1.0mm gap of component L00243 (every 4.0mm).



Symbol Graphic

Note: Component P00175 is centered on and perpendicular to Component L00243.

Component Ref #: L00243      Component Type: Line - Styled      Color Token: Black  
 Description: Black 0.3mm Dashed Line (0.3mm wt, 4.0mm dash, 1.0mm gap)  
Parameters:  
 Line Weight: 0.3mm      Dash Length: 4.0mm      Dash Spacing: 1.0mm

Component Ref #:	P00175	Component Type:	Point - Simple	Color Token:	Black
Description:	Dragons teeth				
<u>Parameters:</u>					
Line Weight:	0.3mm				
Length:	1.0mm				
Note:	The component is an open square.				

Symbol Rules

Reference #:	Description:	Criteria:
PS-04503	Dragon's Teeth / all (area)	All

Label Rules

Label Placement Rules (see Annex J): LP-3505

Reference #:	Description:	Criteria:
PL-04503_1	Dragon's Teeth / all (area)	N/A

Label String: "Dragon's teeth"  
 Characteristics: 1  
 1 (Black, Condensed, 6 pt, Mixed case)

Symbol Samples

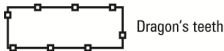

Dragon's Teeth / all (line)

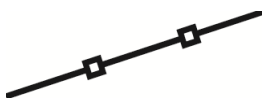

Symbol Graphic

Symbol Placement Instructions: The symbol is applied to the geometry of the feature.  
 Symbol Type: Complex  
 Repeating Point and Interval: Component P00175 is centered in the 1.0mm gap of component L00243 (every 4.0mm).  
 Note: Component P00175 is centered on and perpendicular to Component L00243.

Component Ref #:	L00243	Component Type:	Line - Styled	Color Token:	Black
Description:	Black 0.3mm Dashed Line (0.3mm wt, 4.0mm dash, 1.0mm gap)				
<u>Parameters:</u>					
Line Weight:	0.3mm	Dash Length:	4.0mm	Dash Spacing:	1.0mm

Component Ref #:	P00175	Component Type:	Point - Simple	Color Token:	Black
Description:	Dragons teeth				
<u>Parameters:</u>					
Line Weight:	0.3mm				
Length:	1.0mm				
Note:	The component is an open square.				

Symbol Rules

Reference #:	Description:	Criteria:
PS-04504	Dragon's Teeth / all (line)	All

Label Rules

Label Placement Rules (see Annex J): LP-3505

Reference #:	Description:	Criteria:
PL-04504_1	Dragon's Teeth / all (line)	N/A

Label String: "Dragon's teeth"  
 Characteristics: 1  
 1 (Black, Condensed, 6 pt, Mixed case)

Symbol Samples



## Dry Dock (BB090)

Generalization Rules (see Annex J): GA-9999, GC-9981

### Dry Dock / all (area)



Symbol Graphic

Symbol Placement Instructions: The symbol is applied to the geometry of the feature.

Symbol Type: Simple

Component Ref #:	L00009	Component Type:	Line - Simple	Color Token:	Black
Description:	Black 0.2mm Solid Line				
Parameters:					
Line Weight:	0.2mm				

### Symbol Rules

Reference #:	Description:	Criteria:
PS-04168	Dry Dock / all (area)	All

### Label Rules

Label Placement Rules (see Annex J): LP-3505, LP-9950, LP-9999

Reference #:	Description:	Criteria:
PL-04168_1	Dry Dock / intact (area)	Condition of Facility [FUN] = (Fully Functional [6], Unknown [0])
	Label String: "Dry dock"	
	Characteristics: 1 1 (Black, Condensed, 6 pt, Mixed case)	
PL-04168_2	Dry Dock / not intact (area)	Condition of Facility [FUN] = (Abandoned [2], Damaged [13], Destroyed [3], Dismantled [4], Under Construction [1])
	Label String: "Dry Dock" "["[Condition of Facility]"	
	Characteristics: 1, 22, 22, 22 1 (Black, Condensed, 6 pt, Mixed case) 22 (Black, Condensed, 6 pt, Lower case)	

### Symbol Samples



Dry dock

Shown with Land Water Boundary and Tidal Water:

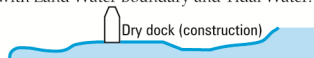

## Electric Power Station (AD010)

Generalization Rules (see Annex J): GA-9999

### Electric Power Station / all (area)



Symbol Graphic

Symbol Placement Instructions: The symbol is applied to the geometry of the feature.

Symbol Type: Simple

<b>Component Ref #:</b>	L00210	<b>Component Type:</b>	Line - Styled	<b>Color Token:</b>	Black
<b>Description:</b>	Black 0.1mm Dashed line (0.1mm wt, 1.0mm dash, 0.5mm gap)				
<b>Parameters:</b>					
<b>Line Weight:</b>	0.1mm	<b>Dash Length:</b>	1.0mm	<b>Dash Spacing:</b>	0.5mm

**Symbol Rules**

<b>Reference #:</b>	<b>Description:</b>	<b>Criteria:</b>
<b>PS-04293</b>	<b>Electric Power Station / all (area)</b>	All

**Label Rules**

Label Placement Rules (see Annex J): LP-3506, LP-4813, LP-9950, LP-9999

<b>Reference #:</b>	<b>Description:</b>	<b>Criteria:</b>
<b>PL-04293_1</b>	<b>Electric Power Station / intact (area)</b>	Condition of Facility [FUN] = (Fully Functional [6], Unknown [0])

**Label String:** [Name] [Power Station Type] "Power plant"  
**Characteristics:** 1, 1, 1  
 1 (Black, Condensed, 6 pt, Mixed case)

<b>Reference #:</b>	<b>Description:</b>	<b>Criteria:</b>
<b>PL-04293_2</b>	<b>Electric Power Station / not intact (area)</b>	Condition of Facility [FUN] = (Abandoned [2], Damaged [13], Destroyed [3], Dismantled [4], Under Construction [1])

**Label String:** [Name] [Power Station Type] "Power plant" ("[Condition of Facility]")  
**Characteristics:** 1, 1, 1, 22, 22, 22  
 1 (Black, Condensed, 6 pt, Mixed case)  
 22 (Black, Condensed, 6 pt, Lower case)

**Symbol Samples**

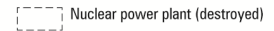
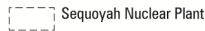

**Electric Power Station / intact (point)**

**Symbol Placement Instructions:** Origin: Center of symbol  
**Symbol Type:** Simple



Symbol Graphic

<b>Component Ref #:</b>	P00006	<b>Component Type:</b>	Point - Simple	<b>Color Token:</b>	Black
<b>Description:</b>	Black filled square with all sides 0.8mm				
<b>Parameters:</b>					
<b>Length:</b>	0.8mm				
<b>Note:</b>	The component is a square and is filled with the solid color.				

**Symbol Rules**

<b>Reference #:</b>	<b>Description:</b>	<b>Criteria:</b>
<b>PS-04294</b>	<b>Electric Power Station / intact (point)</b>	Condition of Facility [FUN] = (Fully Functional [6], Unknown [0])

**Label Rules**

Label Placement Rules (see Annex J): LP-3505, LP-4813, LP-9999

<b>Reference #:</b>	<b>Description:</b>	<b>Criteria:</b>
<b>PL-04294_1</b>	<b>Electric Power Station / intact (point)</b>	N/A

**Label String:** [Name] [Power Station Type] "Power plant"  
**Characteristics:** 1, 1, 1  
 1 (Black, Condensed, 6 pt, Mixed case)

**Symbol Samples**

■ Power plant

■ Oyster Creek Nuclear Power Plant

■ Nuclear power plant

## Electric Power Station / not intact (point)



Symbol Graphic

Symbol Placement Instructions: Origin: Center of symbol

Symbol Type: Simple

Component Ref #: P00173      Component Type: Point - Shape      Color Token: Black/Black-12  
 Description: Not intact square 0.8mm  
[Parameters:](#)  
 Note: See Annex H for detailed drawing instructions.

### Symbol Rules

Reference #:	Description:	Criteria:
PS-04896	Electric Power Station / not intact (point)	Condition of Facility [FUN] = (Abandoned [2], Damaged [13], Destroyed [3], Dismantled [4], Under Construction [1])

### Label Rules

Label Placement Rules (see Annex J): LP-3505

Reference #:	Description:	Criteria:
PL-04896_1	Electric Power Station / not intact (point)	N/A

Label String: "Power plant"  
 Characteristics: 1  
 1 (Black, Condensed, 6 pt, Mixed case)

### Symbol Samples

□ Power plant

## Elevation Contour (CA010)

Generalization Rules (see Annex J): GA-9999

## Elevation Contour / land / index (line)



Symbol Graphic

Symbol Placement Instructions: The symbol is applied to the geometry of the feature.

Symbol Type: Simple

Component Ref #: L00023      Component Type: Line - Simple      Color Token: Dk-Brown1815  
 Description: Dk-Brown1815 0.2mm Solid Line  
[Parameters:](#)  
 Line Weight: 0.2mm

### Symbol Rules

Reference #:	Description:	Criteria:
PS-04342	Elevation Contour / land / index (line)	Elevation Surface Category [ESC] = (Land [1], Unknown [0])

AND Hypsography Portrayal Type [HQC] = (Index Carrying Contour [21], Index Contour [1])

**Label Rules**

Label Placement Rules (see Annex J): LP-3987

<b>Reference #:</b>	<b>Description:</b>	<b>Criteria:</b>
<b>PL-04342_1</b>	<b>Elevation Contour / land / index / greater than zero (line)</b>	Highest Elevation [ZVH] > 0
	<b>Label String:</b> [Highest Elevation]	
	<b>Characteristics:</b> 20 20 (Dk-Brown1815, Condensed, Italic, 7 pt, Lower case)	
<b>PL-04342_2</b>	<b>Elevation Contour / land / index / zero (line)</b>	Highest Elevation [ZVH] = 0
	<b>Label String:</b> "ZERO"	
	<b>Characteristics:</b> 92 92 (Dk-Brown1815, Condensed, Italic, 7 pt, Upper case)	
<b>PL-04342_3</b>	<b>Elevation Contour / land / index / minus (line)</b>	Highest Elevation [ZVH] < 0
	<b>Label String:</b> "MINUS" [Highest Elevation]	
	<b>Characteristics:</b> 92, 20 20 (Dk-Brown1815, Condensed, Italic, 7 pt, Lower case) 92 (Dk-Brown1815, Condensed, Italic, 7 pt, Upper case)	

**Symbol Samples**



**Elevation Contour / land / index / approximate (line)**

Symbol Graphic

**Symbol Placement Instructions:** The symbol is applied to the geometry of the feature.

**Symbol Type:** Simple

<b>Component Ref #:</b>	L00176	<b>Component Type:</b>	Line - Styled	<b>Color Token:</b>	Dk-Brown1815
<b>Description:</b>	Dk-Brown1815 0.2mm Dashed Line (0.2mm wt, 5.0mm dash, 0.5mm gap)				
<b>Parameters:</b>					
<b>Line Weight:</b>	0.2mm	<b>Dash Length:</b>	5.0mm	<b>Dash Spacing:</b>	0.5mm

**Symbol Rules**

<b>Reference #:</b>	<b>Description:</b>	<b>Criteria:</b>
<b>PS-04343</b>	<b>Elevation Contour / land / index / approximate (line)</b>	Elevation Surface Category [ESC] = (Land [1], Unknown [0])
	AND	Hypsography Portrayal Type [HQC] = Approximate Index Contour [7]

**Label Rules**

Label Placement Rules (see Annex J): LP-3987

<b>Reference #:</b>	<b>Description:</b>	<b>Criteria:</b>
<b>PL-04343_1</b>	<b>Elevation Contour / land / index / approximate / greater than zero (line)</b>	Highest Elevation [ZVH] > 0
	<b>Label String:</b> [Highest Elevation]	
	<b>Characteristics:</b> 20 20 (Dk-Brown1815, Condensed, Italic, 7 pt, Lower case)	

**PL-04343\_2** Elevation Contour / land / index / approximate / zero (line) Highest Elevation [ZVH] = 0

Label String: "ZERO"  
 Characteristics: 92  
 92 (Dk-Brown1815, Condensed, Italic, 7 pt, Upper case)

**PL-04343\_3** Elevation Contour / land / index / approximate / minus (line) Highest Elevation [ZVH] < 0

Label String: "MINUS" [Highest Elevation]  
 Characteristics: 92, 20  
 20 (Dk-Brown1815, Condensed, Italic, 7 pt, Lower case)  
 92 (Dk-Brown1815, Condensed, Italic, 7 pt, Upper case)

Symbol Samples



Elevation Contour / land / intermediate (line)



Symbol Graphic

Symbol Placement Instructions: The symbol is applied to the geometry of the feature.

Symbol Type: Simple

Note: Elevation contour values shall not be labeled for intermediate elevation contours except when percent of slope is < 5 in an area >= 150 mm x 150 mm.

Component Ref #: L00107 Component Type: Line - Simple Color Token: Dk-Brown1815  
 Description: Dk-Brown1815 0.1mm Solid Line  
[Parameters:](#)  
 Line Weight: 0.1mm

Symbol Rules

Reference #: Description: Criteria:  
**PS-04346** Elevation Contour / land / intermediate (line) Elevation Surface Category [ESC] = (Land [1], Unknown [0])  
 AND Hypsography Portrayal Type [HQC] = (Intermediate Carrying Contour [19], Intermediate Contour [2])

Label Rules

Label Placement Rules (see Annex J): LP-3987

Reference #: Description: Criteria:  
**PL-04346\_1** Elevation Contour / land / intermediate / greater than zero (line) Highest Elevation [ZVH] > 0

Label String: [Highest Elevation]  
 Characteristics: 20  
 20 (Dk-Brown1815, Condensed, Italic, 7 pt, Lower case)

**PL-04346\_2** Elevation Contour / land / intermediate / zero (line) Highest Elevation [ZVH] = 0

Label String: "ZERO"  
 Characteristics: 92  
 92 (Dk-Brown1815, Condensed, Italic, 7 pt, Upper case)

**PL-04346\_3** Elevation Contour / land / intermediate / minus (line) Highest Elevation [ZVH] < 0

Label String: "MINUS" [Highest Elevation]  
 Characteristics: 92, 20  
 20 (Dk-Brown1815, Condensed, Italic, 7 pt, Lower case)  
 92 (Dk-Brown1815, Condensed, Italic, 7 pt, Upper case)

Symbol Samples



**Elevation Contour / land / intermediate / approximate (line)**



Symbol Graphic

**Symbol Placement Instructions:** The symbol is applied to the geometry of the feature.

**Symbol Type:** Simple

**Note:** Elevation contour values shall not be labeled for intermediate elevation contours except when percent of slope is < 5 in an area >= 150 mm x 150 mm.

<b>Component Ref #:</b>	L00177	<b>Component Type:</b>	Line - Styled	<b>Color Token:</b>	Dk-Brown1815
<b>Description:</b>	Dk-Brown1815 0.1mm Dashed Line (0.1mm wt, 5.0mm dash, 0.5mm gap)				
<b>Parameters:</b>					
<b>Line Weight:</b>	0.1mm	<b>Dash Length:</b>	5.0mm	<b>Dash Spacing:</b>	0.5mm

**Symbol Rules**

Reference #:	Description:	Criteria:
<b>PS-04347</b>	<b>Elevation Contour / land / intermediate / approximate (line)</b>	Elevation Surface Category [ESC] = (Land [1], Unknown [0])
	AND	Hypsography Portrayal Type [HQC] = Approximate Intermediate Contour [12]

**Label Rules**

Label Placement Rules (see Annex J): LP-3987

Reference #:	Description:	Criteria:
<b>PL-04347_1</b>	<b>Elevation Contour / land / intermediate / approximate / greater than zero (line)</b>	Highest Elevation [ZVH] > 0
	<b>Label String:</b> [Highest Elevation]	
	<b>Characteristics:</b> 20 20 (Dk-Brown1815, Condensed, Italic, 7 pt, Lower case)	
<b>PL-04347_2</b>	<b>Elevation Contour / land / intermediate / approximate / zero (line)</b>	Highest Elevation [ZVH] = 0
	<b>Label String:</b> "ZERO"	
	<b>Characteristics:</b> 92 92 (Dk-Brown1815, Condensed, Italic, 7 pt, Upper case)	
<b>PL-04347_3</b>	<b>Elevation Contour / land / intermediate / approximate / minus (ine)</b>	Highest Elevation [ZVH] < 0
	<b>Label String:</b> "MINUS" [Highest Elevation]	
	<b>Characteristics:</b> 92, 20 20 (Dk-Brown1815, Condensed, Italic, 7 pt, Lower case) 92 (Dk-Brown1815, Condensed, Italic, 7 pt, Upper case)	

**Symbol Samples**

**Elevation Contour / land / half auxiliary (line)**

Symbol Placement Instructions: The symbol is applied to the geometry of the feature.

Symbol Type: Simple

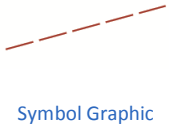

Component Ref #:	L00109	Component Type:	Line - Styled	Color Token:	Dk-Brown1815
Description:	Dk-Brown1815 0.1mm Dashed Line (0.1mm wt, 3.0mm dash, 0.5mm gap)				
<u>Parameters:</u>					
Line Weight:	0.1mm	Dash Length:	3.0mm	Dash Spacing:	0.5mm

### Symbol Rules

Reference #:	Description:	Criteria:
PS-04350	Elevation Contour / land / half auxiliary (line)	Elevation Surface Category [ESC] = (Land [1], Unknown [0])
	AND	Hypsography Portrayal Type [HQC] = (Auxiliary Carrying Contour [20], Half Auxiliary Contour [3])

### Label Rules

Label Placement Rules (see Annex J): LP-3987

Reference #:	Description:	Criteria:
PL-04350_1	Elevation Contour / land / half auxiliary / greater than zero (line)	Highest Elevation [ZVH] > 0
	Label String: [Highest Elevation]	
	Characteristics: 20 20 (Dk-Brown1815, Condensed, Italic, 7 pt, Lower case)	
PL-04350_2	Elevation Contour / land / half auxiliary / zero (line)	Highest Elevation [ZVH] = 0
	Label String: "ZERO"	
	Characteristics: 92 92 (Dk-Brown1815, Condensed, Italic, 7 pt, Upper case)	
PL-04350_3	Elevation Contour / land / half auxiliary / minus (line)	Highest Elevation [ZVH] < 0
	Label String: "MINUS" [Highest Elevation]	
	Characteristics: 92, 20 20 (Dk-Brown1815, Condensed, Italic, 7 pt, Lower case) 92 (Dk-Brown1815, Condensed, Italic, 7 pt, Upper case)	

### Symbol Samples



## Elevation Contour / land / quarter auxiliary (line)

Symbol Placement Instructions: The symbol is applied to the geometry of the feature.

Symbol Type: Simple

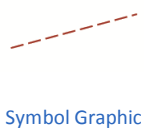

Component Ref #:	L00117	Component Type:	Line - Styled	Color Token:	Dk-Brown1815
Description:	Dk-Brown1815 0.1mm Dashed Line (0.1mm wt, 1.5mm dash, 0.5mm gap)				
<u>Parameters:</u>					
Line Weight:	0.1mm	Dash Length:	1.5mm	Dash Spacing:	0.5mm

### Symbol Rules

Reference #:	Description:	Criteria:

**PS-04360 Elevation Contour / land / quarter auxiliary (line)** Elevation Surface Category [ESC] = (Land [1], Unknown [0])  
 AND Hypsography Portrayal Type [HQC] = Quarter Auxiliary Contour [14]

**Label Rules**

Label Placement Rules (see Annex J): LP-3987

Reference #:	Description:	Criteria:
<b>PL-04360_1</b>	<b>Elevation Contour / land / quarter auxiliary / greater than zero (line)</b>	Highest Elevation [ZVH] > 0
	Label String: [Highest Elevation]	
	Characteristics: 20 20 (Dk-Brown1815, Condensed, Italic, 7 pt, Lower case)	
<b>PL-04360_2</b>	<b>Elevation Contour / land / quarter auxiliary/ zero (line)</b>	Highest Elevation [ZVH] = 0
	Label String: "ZERO"	
	Characteristics: 92 92 (Dk-Brown1815, Condensed, Italic, 7 pt, Upper case)	
<b>PL-04360_3</b>	<b>Elevation Contour / land / quarter auxiliary / minus (line)</b>	Highest Elevation [ZVH] < 0
	Label String: "MINUS" [Highest Elevation]	
	Characteristics: 92, 20 20 (Dk-Brown1815, Condensed, Italic, 7 pt, Lower case) 92 (Dk-Brown1815, Condensed, Italic, 7 pt, Upper case)	

**Symbol Samples**

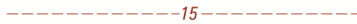

**Elevation Contour / land / mound / index (line)**



Symbol Graphic

**Symbol Placement Instructions:** The symbol is applied to the geometry of the feature.  
**Symbol Type:** Complex  
**Repeating Point and Interval:** The same as the corresponding depression elevation contour.  
**Note:** Component P00065 is perpendicular to and on the downhill side of Component L00023.

<b>Component Ref #:</b>	L00023	<b>Component Type:</b>	Line - Simple	<b>Color Token:</b>	Dk-Brown1815
<b>Description:</b>	Dk-Brown1815 0.2mm Solid Line				
<b>Parameters:</b>					
<b>Line Weight:</b>	0.2mm				

<b>Component Ref #:</b>	P00065	<b>Component Type:</b>	Point - Simple	<b>Color Token:</b>	Dk-Brown1815
<b>Description:</b>	Dk-Brown1815 0.5mm length line with a 0.1mm lineweight				
<b>Parameters:</b>					
<b>Line Weight:</b>	0.1mm				
<b>Length:</b>	0.5mm				

**Symbol Rules**

Reference #:	Description:	Criteria:
<b>PS-04358</b>	<b>Elevation Contour / land / mound / index (line)</b>	Elevation Surface Category [ESC] = (Land [1], Unknown [0])
	AND Hypsography Portrayal Type [HQC] = Mound Index Contour [8]	

**Label Rules**

Label Placement Rules (see Annex J): LP-3987

Reference #:	Description:	Criteria:
<b>PL-04358_1</b>	<b>Elevation Contour / land / mound / index / greater than zero (line)</b>	Highest Elevation [ZVH] > 0

Label String: [Highest Elevation]  
 Characteristics: 20  
 20 (Dk-Brown1815, Condensed, Italic, 7 pt, Lower case)

**PL-04358\_2 Elevation Contour / land / mound / index / zero (line)** Highest Elevation [ZVH] = 0

Label String: "ZERO"  
 Characteristics: 92  
 92 (Dk-Brown1815, Condensed, Italic, 7 pt, Upper case)

**PL-04358\_3 Elevation Contour / land / mound / index / minus (line)** Highest Elevation [ZVH] < 0

Label String: "MINUS" [Highest Elevation]  
 Characteristics: 92, 20  
 20 (Dk-Brown1815, Condensed, Italic, 7 pt, Lower case)  
 92 (Dk-Brown1815, Condensed, Italic, 7 pt, Upper case)

Symbol Samples



**Elevation Contour / land / mound / intermediate (line)**



Symbol Graphic

Symbol Placement Instructions: The symbol is applied to the geometry of the feature.  
 Symbol Type: Complex  
 Repeating Point and Interval: The same as the corresponding depression elevation contour.  
 Note: Component P00065 is perpendicular to and on the downhill side of Component L00107.

Component Ref #: L00107 Component Type: Line - Simple Color Token: Dk-Brown1815  
 Description: Dk-Brown1815 0.1mm Solid Line  
 Parameters:  
 Line Weight: 0.1mm

Component Ref #: P00065 Component Type: Point - Simple Color Token: Dk-Brown1815  
 Description: Dk-Brown1815 0.5mm length line with a 0.1mm lineweight  
 Parameters:  
 Line Weight: 0.1mm  
 Length: 0.5mm

Symbol Rules

Reference #: Description: Criteria:  
**PS-04359 Elevation Contour / land / mound / intermediate (line)** Elevation Surface Category [ESC] = (Land [1], Unknown [0])  
 AND Hypsography Portrayal Type [HQC] = Mound Intermediate Contour [9]

Label Rules

Label Placement Rules (see Annex J): LP-3987

Reference #: Description: Criteria:  
**PL-04359\_1 Elevation Contour / land / mound / intermediate / greater than zero (line)** Highest Elevation [ZVH] > 0

Label String: [Highest Elevation]  
 Characteristics: 20  
 20 (Dk-Brown1815, Condensed, Italic, 7 pt, Lower case)

**PL-04359\_2 Elevation Contour / land / mound / intermediate / zero (line)** Highest Elevation [ZVH] = 0

Label String: "ZERO"  
 Characteristics: 92  
 92 (Dk-Brown1815, Condensed, Italic, 7 pt, Upper case)

**PL-04359\_3** Elevation Contour / land / mound / intermediate / minus (line) Highest Elevation [ZVH] < 0

Label String: "MINUS" [Highest Elevation]  
 Characteristics: 92, 20  
 20 (Dk-Brown1815, Condensed, Italic, 7 pt, Lower case)  
 92 (Dk-Brown1815, Condensed, Italic, 7 pt, Upper case)

Symbol Samples



Elevation Contour / land / depression / index (line)



Symbol Placement Instructions: The symbol is applied to the geometry of the feature.  
 Symbol Type: Complex  
 Repeating Point and Interval: Each depression elevation contour shall have equally spaced ticks extending from the contour towards the lower elevation. The bottom most depression elevation contour shall have a tick interval of 0.5 mm. The first ascending depression contour shall have a tick interval of 1.0 mm, the second shall have a tick interval of 2.0 mm, and all subsequent shall have a tick interval of 3.0.

Symbol Graphic

Note: Component P00065 is perpendicular to and on the downhill side of Component L00023.

Component Ref #:	L00023	Component Type:	Line - Simple	Color Token:	Dk-Brown1815
Description:	Dk-Brown1815 0.2mm Solid Line				
Parameters:					
Line Weight:	0.2mm				
Component Ref #:	P00065	Component Type:	Point - Simple	Color Token:	Dk-Brown1815
Description:	Dk-Brown1815 0.5mm length line with a 0.1mm lineweight				
Parameters:					
Line Weight:	0.1mm				
Length:	0.5mm				

Symbol Rules

Reference #:	Description:	Criteria:
PS-04354	Elevation Contour / land / depression / index (line)	Elevation Surface Category [ESC] = (Land [1], Unknown [0])
	AND	Hypsography Portrayal Type [HQC] = Depression Index Contour [5]

Label Rules

Label Placement Rules (see Annex J): LP-3987

Reference #:	Description:	Criteria:
PL-04354_1	Elevation Contour / land / depression / index / greater than zero (line)	Highest Elevation [ZVH] > 0
	Label String: [Highest Elevation]	
	Characteristics: 20 20 (Dk-Brown1815, Condensed, Italic, 7 pt, Lower case)	
PL-04354_2	Elevation Contour / land / depression / index / zero (line)	Highest Elevation [ZVH] = 0
	Label String: "ZERO"	
	Characteristics: 92 92 (Dk-Brown1815, Condensed, Italic, 7 pt, Upper case)	
PL-04354_3	Elevation Contour / land / depression / index / minus (line)	Highest Elevation [ZVH] < 0
	Label String: "MINUS" [Highest Elevation]	
	Characteristics: 92, 20 20 (Dk-Brown1815, Condensed, Italic, 7 pt, Lower case) 92 (Dk-Brown1815, Condensed, Italic, 7 pt, Upper case)	

Symbol Samples

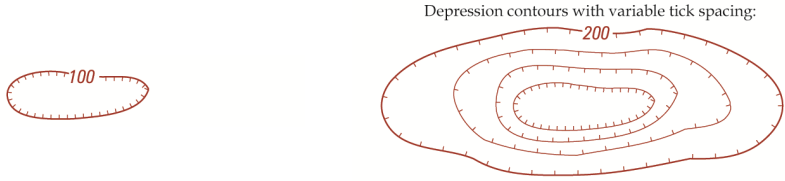

**Elevation Contour / land / depression / intermediate (line)**



**Symbol Placement Instructions:** The symbol is applied to the geometry of the feature.

**Symbol Type:** Complex

**Repeating Point and Interval:** Each depression elevation contour shall have equally spaced ticks extending from the contour towards the lower elevation. The bottom most depression elevation contour shall have a tick interval of 0.5 mm. The first ascending depression contour shall have a tick interval of 1.0 mm, the second shall have a tick interval of 2.0 mm, and all subsequent shall have a tick interval of 3.0.

Symbol Graphic

**Note:** Component P00065 is perpendicular to and on the downhill side of Component L00107. Elevation contour values shall not be labeled for intermediate elevation contours except when percent of slope is < 5 in an area >= 150 mm x 150 mm.

<b>Component Ref #:</b>	L00107	<b>Component Type:</b>	Line - Simple	<b>Color Token:</b>	Dk-Brown1815
<b>Description:</b>	Dk-Brown1815 0.1mm Solid Line				
<b>Parameters:</b>					
<b>Line Weight:</b>	0.1mm				
<b>Component Ref #:</b>	P00065	<b>Component Type:</b>	Point - Simple	<b>Color Token:</b>	Dk-Brown1815
<b>Description:</b>	Dk-Brown1815 0.5mm length line with a 0.1mm lineweight				
<b>Parameters:</b>					
<b>Line Weight:</b>	0.1mm				
<b>Length:</b>	0.5mm				

**Symbol Rules**

<b>Reference #:</b>	<b>Description:</b>	<b>Criteria:</b>
PS-04356	Elevation Contour / land / depression / intermediate (line)	Elevation Surface Category [ESC] = (Land [1], Unknown [0])
	AND	Hypsography Portrayal Type [HQC] = Depression Intermediate Contour [6]

**Label Rules**

Label Placement Rules (see Annex J): LP-3987

<b>Reference #:</b>	<b>Description:</b>	<b>Criteria:</b>
PL-04356_1	Elevation Contour / land / depression / intermediate / greater than zero (line)	Highest Elevation [ZVH] > 0
	<b>Label String:</b> [Highest Elevation]	
	<b>Characteristics:</b> 20 20 (Dk-Brown1815, Condensed, Italic, 7 pt, Lower case)	
PL-04356_2	Elevation Contour / land / depression / intermediate / zero (line)	Highest Elevation [ZVH] = 0
	<b>Label String:</b> "ZERO"	
	<b>Characteristics:</b> 92 92 (Dk-Brown1815, Condensed, Italic, 7 pt, Upper case)	
PL-04356_3	Elevation Contour / land / depression / intermediate / minus (line)	Highest Elevation [ZVH] < 0
	<b>Label String:</b> "MINUS" [Highest Elevation]	
	<b>Characteristics:</b> 92, 20 20 (Dk-Brown1815, Condensed, Italic, 7 pt, Lower case) 92 (Dk-Brown1815, Condensed, Italic, 7 pt, Upper case)	

**Symbol Samples**

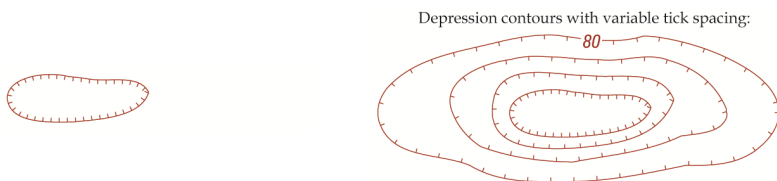

## Elevation Contour / land / depression / auxiliary (line)



Symbol Graphic

**Symbol Placement Instructions:** The symbol is applied to the geometry of the feature.

**Symbol Type:** Complex

**Repeating Point and Interval:** Component P00065 is centered on every dash of Component L00109.

**Note:** Component P00065 is perpendicular to and on the downhill side of Component L00109.

<b>Component Ref #:</b>	L00109	<b>Component Type:</b>	Line - Styled	<b>Color Token:</b>	Dk-Brown1815
<b>Description:</b>	Dk-Brown1815 0.1mm Dashed Line (0.1mm wt, 3.0mm dash, 0.5mm gap)				
<b>Parameters:</b>					
<b>Line Weight:</b>	0.1mm	<b>Dash Length:</b>	3.0mm	<b>Dash Spacing:</b>	0.5mm
<b>Component Ref #:</b>	P00065	<b>Component Type:</b>	Point - Simple	<b>Color Token:</b>	Dk-Brown1815
<b>Description:</b>	Dk-Brown1815 0.5mm length line with a 0.1mm lineweight				
<b>Parameters:</b>					
<b>Line Weight:</b>	0.1mm				
<b>Length:</b>	0.5mm				

### Symbol Rules

Reference #:	Description:	Criteria:
<b>PS-04362</b>	<b>Elevation Contour / land / depression / auxiliary (line)</b>	Elevation Surface Category [ESC] = (Land [1], Unknown [0])
	AND	Hypsography Portrayal Type [HQC] = Depression Auxiliary Contour [22]

### Label Rules

Label Placement Rules (see Annex J): LP-3987

Reference #:	Description:	Criteria:
<b>PL-04362_1</b>	<b>Elevation Contour / land / depression / auxiliary / greater than zero (line)</b>	Highest Elevation [ZVH] > 0
	<b>Label String:</b> [Highest Elevation]	
	<b>Characteristics:</b> 20 20 (Dk-Brown1815, Condensed, Italic, 7 pt, Lower case)	
<b>PL-04362_2</b>	<b>Elevation Contour / land / depression / auxiliary / zero (line)</b>	Highest Elevation [ZVH] = 0
	<b>Label String:</b> "ZERO"	
	<b>Characteristics:</b> 92 92 (Dk-Brown1815, Condensed, Italic, 7 pt, Upper case)	
<b>PL-04362_3</b>	<b>Elevation Contour / land / depression / auxiliary / minus (line)</b>	Highest Elevation [ZVH] < 0
	<b>Label String:</b> "MINUS" [Highest Elevation]	
	<b>Characteristics:</b> 92, 20 20 (Dk-Brown1815, Condensed, Italic, 7 pt, Lower case) 92 (Dk-Brown1815, Condensed, Italic, 7 pt, Upper case)	

### Symbol Samples



## Elevation Contour / snow, ice / index (line)



Symbol Graphic

**Symbol Placement Instructions:** The symbol is applied to the geometry of the feature.

**Symbol Type:** Simple

Component Ref #: L00015      Component Type: Line - Simple      Color Token: Cyan  
 Description: Cyan 0.2mm Solid Line  
Parameters:  
 Line Weight: 0.2mm

**Symbol Rules**

Reference #: Description: Criteria:  
**PS-04344** Elevation Contour / snow, ice / index (line) Elevation Surface Category [ESC] = Snow Field and/or Ice-field [2]  
 AND Hypsography Portrayal Type [HQC] = (Index Carrying Contour [21], Index Contour [1])

**Label Rules**

Label Placement Rules (see Annex J): LP-3987

Reference #: Description: Criteria:  
**PL-04344\_1** Elevation Contour / snow, ice / index / greater than zero (line) Highest Elevation [ZVH] > 0  
 Label String: [Highest Elevation]  
 Characteristics: 19  
 19 (Cyan, Condensed, Italic, 7 pt, Lower case)  
**PL-04344\_2** Elevation Contour / snow, ice / index / zero (line) Highest Elevation [ZVH] = 0  
 Label String: "ZERO"  
 Characteristics: 90  
 90 (Cyan, Condensed, Italic, 7 pt, Upper case)  
**PL-04344\_3** Elevation Contour / snow, ice / index / minus (line) Highest Elevation [ZVH] < 0  
 Label String: "MINUS" [Highest Elevation]  
 Characteristics: 90, 19  
 19 (Cyan, Condensed, Italic, 7 pt, Lower case)  
 90 (Cyan, Condensed, Italic, 7 pt, Upper case)

**Symbol Samples**



**Elevation Contour / snow, ice / index / approximate (line)**

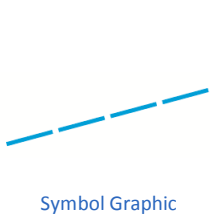

Symbol Placement Instructions: The symbol is applied to the geometry of the feature.  
 Symbol Type: Simple

Component Ref #: L00042      Component Type: Line - Styled      Color Token: Cyan  
 Description: Cyan 0.2mm Dashed Line (0.2mm wt, 5.0mm dash, 0.5mm gap)  
Parameters:  
 Line Weight: 0.2mm      Dash Length: 5.0mm      Dash Spacing: 0.5mm

**Symbol Rules**

Reference #: Description: Criteria:  
**PS-04345** Elevation Contour / snow, ice / index / approximate (line) Elevation Surface Category [ESC] = Snow Field and/or Ice-field [2]  
 AND Hypsography Portrayal Type [HQC] = Approximate Index Contour [7]

**Label Rules**

Label Placement Rules (see Annex J): LP-3987

Reference #: Description: Criteria:  
**PL-04345\_1** Elevation Contour / snow, ice / index / approximate / Highest Elevation [ZVH] > 0



**greater than zero (line)**

Label String: [Highest Elevation]

Characteristics: 19  
19 (Cyan, Condensed, Italic, 7 pt, Lower case)

**PL-04345\_2 Elevation Contour / snow, ice / index / approximate/ zero (line)** Highest Elevation [ZVH] = 0

Label String: "ZERO"

Characteristics: 90  
90 (Cyan, Condensed, Italic, 7 pt, Upper case)

**PL-04345\_3 Elevation Contour / snow, ice / index / approximate / minus (line)** Highest Elevation [ZVH] < 0

Label String: "MINUS" [Highest Elevation]

Characteristics: 90, 19  
19 (Cyan, Condensed, Italic, 7 pt, Lower case)  
90 (Cyan, Condensed, Italic, 7 pt, Upper case)

**Symbol Samples**

----- 300 -----

**Elevation Contour / snow, ice / intermediate (line)**



Symbol Graphic

Symbol Placement Instructions: The symbol is applied to the geometry of the feature.

Symbol Type: Simple

Note: Elevation contour values shall not be labeled for intermediate elevation contours except when percent of slope is < 5 in an area >= 150 mm x 150 mm.

Component Ref #:	L00108	Component Type:	Line - Simple	Color Token:	Cyan
Description:	Cyan 0.1mm Solid Line				
Parameters:					
Line Weight:	0.1mm				

**Symbol Rules**

Reference #:	Description:	Criteria:
PS-04348	<b>Elevation Contour / snow, ice / intermediate (line)</b>	Elevation Surface Category [ESC] = Snow Field and/or Ice-field [2]
	AND	Hypsography Portrayal Type [HQC] = (Intermediate Carrying Contour [19], Intermediate Contour [2])

**Label Rules**

Label Placement Rules (see Annex J): LP-3987

Reference #:	Description:	Criteria:
PL-04348_1	<b>Elevation Contour / snow, ice / intermediate / greater than zero (line)</b>	Highest Elevation [ZVH] > 0
	Label String: [Highest Elevation]	
	Characteristics: 19 19 (Cyan, Condensed, Italic, 7 pt, Lower case)	
PL-04348_2	<b>Elevation Contour / snow, ice / intermediate / zero (line)</b>	Highest Elevation [ZVH] = 0
	Label String: "ZERO"	
	Characteristics: 90 90 (Cyan, Condensed, Italic, 7 pt, Upper case)	

**PL-04348\_3 Elevation Contour / snow, ice / intermediate / minus (line)**

Highest Elevation [ZVH] < 0

- Label String: "MINUS" [Highest Elevation]
- Characteristics: 90, 19  
19 (Cyan, Condensed, Italic, 7 pt, Lower case)  
90 (Cyan, Condensed, Italic, 7 pt, Upper case)

Symbol Samples

**Elevation Contour / snow, ice / intermediate / approximate (line)**



Symbol Graphic

Symbol Placement Instructions: The symbol is applied to the geometry of the feature.

Symbol Type: Simple

Note: Elevation contour values shall not be labeled for intermediate elevation contours except when percent of slope is < 5 in an area >= 150 mm x 150 mm.

Component Ref #:	L00178	Component Type:	Line - Styled	Color Token:	Cyan
Description:	Cyan 0.1mm Dashed Line (0.1mm wt, 5.0mm dash, 0.5mm gap)				
Parameters:					
Line Weight:	0.1mm	Dash Length:	5.0mm	Dash Spacing:	0.5mm

Symbol Rules

Reference #:	Description:	Criteria:
PS-04349	Elevation Contour / snow, ice / intermediate / approximate (line)	Elevation Surface Category [ESC] = Snow Field and/or Ice-field [2]
	AND	Hypsography Portrayal Type [HQC] = Approximate Intermediate Contour [12]

Label Rules

Label Placement Rules (see Annex J): LP-3987

Reference #:	Description:	Criteria:
PL-04349_1	Elevation Contour / snow, ice / intermediate / approximate / greater than zero (line)	Highest Elevation [ZVH] > 0
	Label String: [Highest Elevation]	
	Characteristics: 19 19 (Cyan, Condensed, Italic, 7 pt, Lower case)	
PL-04349_2	Elevation Contour / snow, ice / intermediate / approximate / zero (line)	Highest Elevation [ZVH] = 0
	Label String: "ZERO"	
	Characteristics: 90 90 (Cyan, Condensed, Italic, 7 pt, Upper case)	
PL-04349_3	Elevation Contour / snow, ice / intermediate / approximate / minus (line)	Highest Elevation [ZVH] < 0
	Label String: "MINUS" [Highest Elevation]	
	Characteristics: 90, 19 19 (Cyan, Condensed, Italic, 7 pt, Lower case) 90 (Cyan, Condensed, Italic, 7 pt, Upper case)	

Symbol Samples

## Elevation Contour / snow, ice / half auxiliary (line)



Symbol Graphic

**Symbol Placement Instructions:** The symbol is applied to the geometry of the feature.

**Symbol Type:** Simple

<b>Component Ref #:</b>	L00110	<b>Component Type:</b>	Line - Styled	<b>Color Token:</b>	Cyan
<b>Description:</b>	Cyan 0.1mm Dashed Line (0.1mm wt, 3.0mm dash, 0.5mm gap)				
<b>Parameters:</b>					
<b>Line Weight:</b>	0.1mm	<b>Dash Length:</b>	3.0mm	<b>Dash Spacing:</b>	0.5mm

### Symbol Rules

Reference #:	Description:	Criteria:
<b>PS-04351</b>	<b>Elevation Contour / snow, ice / half auxiliary (line)</b>	Elevation Surface Category [ESC] = Snow Field and/or Ice-field [2]
	AND	Hypsography Portrayal Type [HQC] = (Auxiliary Carrying Contour [20], Half Auxiliary Contour [3])

### Label Rules

Label Placement Rules (see Annex J): LP-3987

Reference #:	Description:	Criteria:
<b>PL-04351_1</b>	<b>Elevation Contour / snow, ice / half auxiliary / greater than zero (line)</b>	Highest Elevation [ZVH] > 0
	<b>Label String:</b> [Highest Elevation]	
	<b>Characteristics:</b> 19 19 (Cyan, Condensed, Italic, 7 pt, Lower case)	
<b>PL-04351_2</b>	<b>Elevation Contour / snow, ice / half auxiliary / zero (line)</b>	Highest Elevation [ZVH] = 0
	<b>Label String:</b> "ZERO"	
	<b>Characteristics:</b> 90 90 (Cyan, Condensed, Italic, 7 pt, Upper case)	
<b>PL-04351_3</b>	<b>Elevation Contour / snow, ice / half auxiliary / minus (line)</b>	Highest Elevation [ZVH] < 0
	<b>Label String:</b> "MINUS" [Highest Elevation]	
	<b>Characteristics:</b> 90, 19 19 (Cyan, Condensed, Italic, 7 pt, Lower case) 90 (Cyan, Condensed, Italic, 7 pt, Upper case)	

### Symbol Samples



## Elevation Contour / snow, ice / quarter auxiliary (line)



Symbol Graphic

**Symbol Placement Instructions:** The symbol is applied to the geometry of the feature.

**Symbol Type:** Simple

<b>Component Ref #:</b>	L00118	<b>Component Type:</b>	Line - Styled	<b>Color Token:</b>	Cyan
<b>Description:</b>	Cyan 0.1mm Dashed Line (0.1mm wt, 1.5mm dash, 0.5mm gap)				
<b>Parameters:</b>					
<b>Line Weight:</b>	0.1mm	<b>Dash Length:</b>	1.5mm	<b>Dash Spacing:</b>	0.5mm

Symbol Rules

Reference #:	Description:	Criteria:
<b>PS-04361</b>	<b>Elevation Contour / snow, ice / quarter auxiliary (line)</b>	Elevation Surface Category [ESC] = Snow Field and/or Ice-field [2]
	AND	Hypsography Portrayal Type [HQC] = Quarter Auxiliary Contour [14]

Label Rules

Label Placement Rules (see Annex J): LP-3987

Reference #:	Description:	Criteria:
<b>PL-04361_1</b>	<b>Elevation Contour / snow, ice / quarter auxiliary / greater than zero (line)</b>	Highest Elevation [ZVH] > 0
	Label String: [Highest Elevation]	
	Characteristics: 19 19 (Cyan, Condensed, Italic, 7 pt, Lower case)	
<b>PL-04361_2</b>	<b>Elevation Contour / snow, ice / quarter auxiliary / zero (line)</b>	Highest Elevation [ZVH] = 0
	Label String: "ZERO"	
	Characteristics: 90 90 (Cyan, Condensed, Italic, 7 pt, Upper case)	
<b>PL-04361_3</b>	<b>Elevation Contour / snow, ice / quarter auxiliary / minus (line)</b>	Highest Elevation [ZVH] < 0
	Label String: "MINUS" [Highest Elevation]	
	Characteristics: 90, 19 19 (Cyan, Condensed, Italic, 7 pt, Lower case) 90 (Cyan, Condensed, Italic, 7 pt, Upper case)	

Symbol Samples

-----15-----

Elevation Contour / snow, ice / mound / index (line)

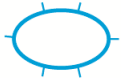

Symbol Graphic

Symbol Placement Instructions: The symbol is applied to the geometry of the feature.  
 Symbol Type: Complex  
 Repeating Point and Interval: The same as the corresponding depression elevation contour.  
 Note: Component P00055 is perpendicular to and on the downhill side of Component L00015.

Component Ref #:	L00015	Component Type:	Line - Simple	Color Token:	Cyan
Description:	Cyan 0.2mm Solid Line				
Parameters:					
Line Weight:	0.2mm				
Component Ref #:	P00055	Component Type:	Point - Simple	Color Token:	Cyan
Description:	Cyan 0.5mm length line with a 0.1mm lineweight				
Parameters:					
Line Weight:	0.1mm				
Length:	0.5mm				

Symbol Rules

Reference #:	Description:	Criteria:
<b>PS-04738</b>	<b>Elevation Contour / snow, ice / mound / index (line)</b>	Elevation Surface Category [ESC] = Snow Field and/or Ice-field [2]
	AND	Hypsography Portrayal Type [HQC] = Mound Index Contour [8]

Label Rules

Label Placement Rules (see Annex J): LP-3987

Reference #:	Description:	Criteria:
--------------	--------------	-----------

- PL-04738\_1**    **Elevation Contour / snow, ice / mound / index / greater than zero (line)**    Highest Elevation [ZVH] > 0

Label String:    [Highest Elevation]

Characteristics: 19  
19 (Cyan, Condensed, Italic, 7 pt, Lower case)
- PL-04738\_2**    **Elevation Contour / snow, ice / mound / index / zero (line)**    Highest Elevation [ZVH] = 0

Label String:    "ZERO"

Characteristics: 90  
90 (Cyan, Condensed, Italic, 7 pt, Upper case)
- PL-04738\_3**    **Elevation Contour / snow, ice / mound / index / minus (line)**    Highest Elevation [ZVH] < 0

Label String:    "MINUS" [Highest Elevation]

Characteristics: 90, 19  
19 (Cyan, Condensed, Italic, 7 pt, Lower case)  
90 (Cyan, Condensed, Italic, 7 pt, Upper case)

Symbol Samples



**Elevation Contour / snow, ice / mound / intermediate (line)**

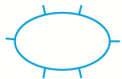

Symbol Graphic

**Symbol Placement Instructions:**    The symbol is applied to the geometry of the feature.

**Symbol Type:**    Complex

**Repeating Point and Interval:**    The same as the corresponding depression elevation contour.

**Note:**    Component P00055 is perpendicular to and on the downhill side of Component L00108.

<b>Component Ref #:</b>	L00108	<b>Component Type:</b>	Line - Simple	<b>Color Token:</b>	Cyan
<b>Description:</b>	Cyan 0.1mm Solid Line				
<b>Parameters:</b>					
<b>Line Weight:</b>	0.1mm				
<b>Component Ref #:</b>	P00055	<b>Component Type:</b>	Point - Simple	<b>Color Token:</b>	Cyan
<b>Description:</b>	Cyan 0.5mm length line with a 0.1mm lineweight				
<b>Parameters:</b>					
<b>Line Weight:</b>	0.1mm				
<b>Length:</b>	0.5mm				

Symbol Rules

<b>Reference #:</b>	<b>Description:</b>	<b>Criteria:</b>
<b>PS-04739</b>	<b>Elevation Contour / snow, ice / mound / intermediate (line)</b>	Elevation Surface Category [ESC] = Snow Field and/or Ice-field [2]
		AND    Hypsography Portrayal Type [HQC] = Mound Intermediate Contour [9]

Label Rules

<b>Label Placement Rules (see Annex J):</b> LP-3987		
<b>Reference #:</b>	<b>Description:</b>	<b>Criteria:</b>
<b>PL-04739_1</b>	<b>Elevation Contour / snow, ice / mound / intermediate / greater than zero (line)</b>	Highest Elevation [ZVH] > 0
	Label String:    [Highest Elevation]	
	Characteristics: 19 19 (Cyan, Condensed, Italic, 7 pt, Lower case)	

- PL-04739\_2**    **Elevation Contour / snow, ice / mound / intermediate/ zero (line)**    Highest Elevation [ZVH] = 0

Label String: "ZERO"

Characteristics: 90  
90 (Cyan, Condensed, Italic, 7 pt, Upper case)
- PL-04739\_3**    **Elevation Contour / snow, ice / mound / intermediate/ minus (line)**    Highest Elevation [ZVH] < 0

Label String: "MINUS" [Highest Elevation]

Characteristics: 90, 19  
19 (Cyan, Condensed, Italic, 7 pt, Lower case)  
90 (Cyan, Condensed, Italic, 7 pt, Upper case)

**Symbol Samples**



**Elevation Contour / snow, ice / depression / index (line)**

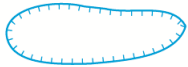

**Symbol Placement Instructions:** The symbol is applied to the geometry of the feature.

**Symbol Type:** Complex

**Repeating Point and Interval:** Each depression elevation contour shall have equally spaced ticks extending from the contour towards the lower elevation. The bottom most depression elevation contour shall have a tick interval of 0.5 mm. The first ascending depression contour shall have a tick interval of 1.0 mm, the second shall have a tick interval of 2.0 mm, and all subsequent shall have a tick interval of 3.0.

Symbol Graphic

**Note:** Component P00055 is perpendicular to and on the downhill side of Component L00015.

<b>Component Ref #:</b>	L00015	<b>Component Type:</b>	Line - Simple	<b>Color Token:</b>	Cyan
<b>Description:</b>	Cyan 0.2mm Solid Line				
<b>Parameters:</b>					
<b>Line Weight:</b>	0.2mm				
<b>Component Ref #:</b>	P00055	<b>Component Type:</b>	Point - Simple	<b>Color Token:</b>	Cyan
<b>Description:</b>	Cyan 0.5mm length line with a 0.1mm lineweight				
<b>Parameters:</b>					
<b>Line Weight:</b>	0.1mm				
<b>Length:</b>	0.5mm				

**Symbol Rules**

<b>Reference #:</b>	<b>Description:</b>	<b>Criteria:</b>
<b>PS-04355</b>	<b>Elevation Contour / snow, ice / depression / index (line)</b>	Elevation Surface Category [ESC] = Snow Field and/or Ice-field [2]
		AND Hypsography Portrayal Type [HQC] = Depression Index Contour [5]

**Label Rules**

Label Placement Rules (see Annex J): LP-3987

<b>Reference #:</b>	<b>Description:</b>	<b>Criteria:</b>
<b>PL-04355_1</b>	<b>Elevation Contour / snow, ice / depression / index / greater than zero (line)</b>	Highest Elevation [ZVH] > 0
	Label String: [Highest Elevation]	
	Characteristics: 19 19 (Cyan, Condensed, Italic, 7 pt, Lower case)	
<b>PL-04355_2</b>	<b>Elevation Contour / snow, ice / depression / index / zero (line)</b>	Highest Elevation [ZVH] = 0
	Label String: "ZERO"	
	Characteristics: 90 90 (Cyan, Condensed, Italic, 7 pt, Upper case)	

**PL-04355\_3 Elevation Contour / snow, ice / depression / index / minus (line)**

Highest Elevation [ZVH] < 0

- Label String: "MINUS" [Highest Elevation]
- Characteristics: 90, 19  
19 (Cyan, Condensed, Italic, 7 pt, Lower case)  
90 (Cyan, Condensed, Italic, 7 pt, Upper case)

**Symbol Samples**

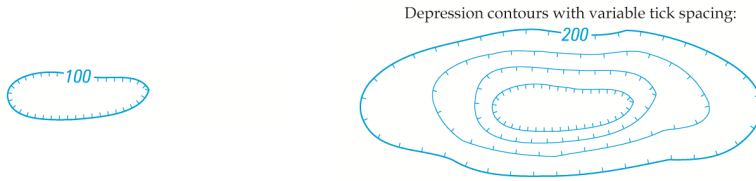

**Elevation Contour / snow, ice / depression / intermediate (line)**

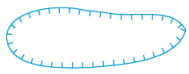

Symbol Graphic

**Symbol Placement Instructions:** The symbol is applied to the geometry of the feature.

**Symbol Type:** Complex

**Repeating Point and Interval:** Each depression elevation contour shall have equally spaced ticks extending from the contour towards the lower elevation. The bottom most depression elevation contour shall have a tick interval of 0.5 mm. The first ascending depression contour shall have a tick interval of 1.0 mm, the second shall have a tick interval of 2.0 mm, and all subsequent shall have a tick interval of 3.0.

**Note:** Component P00055 is perpendicular to and on the downhill side of Component L00108. Elevation contour values shall not be labeled for intermediate elevation contours except when percent of slope is < 5 in an area >= 150 mm x 150 mm.

<b>Component Ref #:</b>	L00108	<b>Component Type:</b>	Line - Simple	<b>Color Token:</b>	Cyan
<b>Description:</b>	Cyan 0.1mm Solid Line				
<b>Parameters:</b>					
<b>Line Weight:</b>	0.1mm				
<hr/>					
<b>Component Ref #:</b>	P00055	<b>Component Type:</b>	Point - Simple	<b>Color Token:</b>	Cyan
<b>Description:</b>	Cyan 0.5mm length line with a 0.1mm linewidth				
<b>Parameters:</b>					
<b>Line Weight:</b>	0.1mm				
<b>Length:</b>	0.5mm				

**Symbol Rules**

<b>Reference #:</b>	<b>Description:</b>	<b>Criteria:</b>
PS-04357	Elevation Contour / snow, ice / depression / intermediate (line)	Elevation Surface Category [ESC] = Snow Field and/or Ice-field [2]
	AND	Hypsography Portrayal Type [HQC] = Depression Intermediate Contour [6]

**Label Rules**

<b>Label Placement Rules (see Annex J):</b>		LP-3987
<b>Reference #:</b>	<b>Description:</b>	<b>Criteria:</b>
PL-04357_1	Elevation Contour / snow, ice / depression / intermediate / greater than zero (line)	Highest Elevation [ZVH] > 0
	Label String: [Highest Elevation]	
	Characteristics: 19 19 (Cyan, Condensed, Italic, 7 pt, Lower case)	
PL-04357_2	Elevation Contour / snow, ice / depression / intermediate / zero (line)	Highest Elevation [ZVH] = 0
	Label String: "ZERO"	
	Characteristics: 90 90 (Cyan, Condensed, Italic, 7 pt, Upper case)	
PL-04357_3	Elevation Contour / snow, ice / depression / intermediate / minus (line)	Highest Elevation [ZVH] < 0
	Label String: "MINUS" [Highest Elevation]	
	Characteristics: 90, 19 19 (Cyan, Condensed, Italic, 7 pt, Lower case) 90 (Cyan, Condensed, Italic, 7 pt, Upper case)	

Symbol Samples

Depression contours with variable tick spacing:

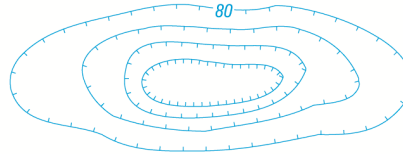
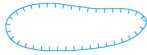

Elevation Contour / snow, ice / depression / auxiliary (line)



Symbol Graphic

Symbol Placement Instructions: The symbol is applied to the geometry of the feature.

Symbol Type: Complex

Repeating Point and Interval: Component P00055 is centered on every dash of Component L00110.

Note: Component P00055 is perpendicular to and on the downhill side of Component L00110.

Component Ref #:	L00110	Component Type:	Line - Styled	Color Token:	Cyan
Description:	Cyan 0.1mm Dashed Line (0.1mm wt, 3.0mm dash, 0.5mm gap)				
Parameters:					
Line Weight:	0.1mm	Dash Length:	3.0mm	Dash Spacing:	0.5mm
Component Ref #:	P00055	Component Type:	Point - Simple	Color Token:	Cyan
Description:	Cyan 0.5mm length line with a 0.1mm lineweight				
Parameters:					
Line Weight:	0.1mm				
Length:	0.5mm				

Symbol Rules

Reference #:	Description:	Criteria:
PS-04363	Elevation Contour / snow, ice / depression / auxiliary (line)	Elevation Surface Category [ESC] = Snow Field and/or Ice-field [2]
	AND	Hypsography Portrayal Type [HQC] = Depression Auxiliary Contour [22]

Label Rules

Label Placement Rules (see Annex J): LP-3987

Reference #:	Description:	Criteria:
PL-04363_1	Elevation Contour / snow, ice / depression / auxiliary / greater than zero (line)	Highest Elevation [ZVH] > 0
	Label String: [Highest Elevation]	
	Characteristics: 19 19 (Cyan, Condensed, Italic, 7 pt, Lower case)	
PL-04363_2	Elevation Contour / snow, ice / depression / auxiliary / zero (line)	Highest Elevation [ZVH] = 0
	Label String: "ZERO"	
	Characteristics: 90 90 (Cyan, Condensed, Italic, 7 pt, Upper case)	
PL-04363_3	Elevation Contour / snow, ice / depression / auxiliary / minus (line)	Highest Elevation [ZVH] < 0
	Label String: "MINUS" [Highest Elevation]	
	Characteristics: 90, 19 19 (Cyan, Condensed, Italic, 7 pt, Lower case) 90 (Cyan, Condensed, Italic, 7 pt, Upper case)	

Symbol Samples





# Embankment (DB090)

Generalization Rules (see Annex J): GA-9999

## Embankment / all (area)

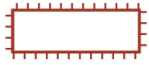

Symbol Graphic

**Symbol Placement Instructions:** The symbol is applied to the geometry of the feature.

**Symbol Type:** Complex

**Repeating Point and Interval:** Component P00174; 1.5mm

**Note:** Component P00174 is attached perpendicular to and on the downhill side of Component L00240.

<b>Component Ref #:</b>	L00240	<b>Component Type:</b>	Line - Simple	<b>Color Token:</b>	Dk-Brown1815
<b>Description:</b>	Dk-Brown1815 0.15mm Solid Line				
<b>Parameters:</b>					
<b>Line Weight:</b>	0.15mm				

<b>Component Ref #:</b>	P00174	<b>Component Type:</b>	Point - Simple	<b>Color Token:</b>	Dk-Brown1815
<b>Description:</b>	Dk-Brown1815 0.5mm length line with 0.15mm lineweight				
<b>Parameters:</b>					
<b>Line Weight:</b>	0.15mm				
<b>Length:</b>	0.5mm				

### Symbol Rules

<b>Reference #:</b>	<b>Description:</b>	<b>Criteria:</b>
PS-04246	Embankment / all (area)	All

### Symbol Samples



## Embankment / fill (line)



Symbol Graphic

**Symbol Placement Instructions:** The symbol is applied to the geometry of the feature.

**Symbol Type:** Complex

**Repeating Point and Interval:** Component P00174 has an initial offset of 0.75mm; after that 1.5mm.

**Note:** Component P00174 is perpendicular to and on the downhill side of Component L00240.

<b>Component Ref #:</b>	L00240	<b>Component Type:</b>	Line - Simple	<b>Color Token:</b>	Dk-Brown1815
<b>Description:</b>	Dk-Brown1815 0.15mm Solid Line				
<b>Parameters:</b>					
<b>Line Weight:</b>	0.15mm				

<b>Component Ref #:</b>	P00174	<b>Component Type:</b>	Point - Simple	<b>Color Token:</b>	Dk-Brown1815
<b>Description:</b>	Dk-Brown1815 0.5mm length line with 0.15mm lineweight				
<b>Parameters:</b>					
<b>Line Weight:</b>	0.15mm				
<b>Length:</b>	0.5mm				

### Symbol Rules

<b>Reference #:</b>	<b>Description:</b>	<b>Criteria:</b>
PS-04248	Embankment / fill (line)	Embankment Type [FIC] = Fill [2] AND Transportation System Type [TRS] = (Not Applicable [998], Other [999], Pedestrian [9], Unknown [0])

### Symbol Samples



### Embankment / with transportation (line)



Symbol Graphic

**Symbol Placement Instructions:** The symbol is applied to the geometry of the feature.

**Symbol Type:** Complex

**Repeating Point and Interval:** Component P00174 has an initial offset of 0.75mm; after that 1.5mm.

**Note:** Component P00174 is perpendicular to and on the downhill side of each Component L00241.

<b>Component Ref #:</b>	L00241	<b>Component Type:</b>	Line - Simple	<b>Color Token:</b>	Dk-Brown1815
<b>Description:</b>	Two parallel Dk-Brown1815 0.15mm Solid Lines				
<b>Parameters:</b>					
<b>Line Weight:</b>	0.15mm				
<b>Note:</b>	Spacing is variable based on the width of the overpassing feature. The minimum space between each line and the linear portion of the overpassing feature shall be 0.2 mm.				

<b>Component Ref #:</b>	P00174	<b>Component Type:</b>	Point - Simple	<b>Color Token:</b>	Dk-Brown1815
<b>Description:</b>	Dk-Brown1815 0.5mm length line with 0.15mm lineweight				
<b>Parameters:</b>					
<b>Line Weight:</b>	0.15mm				
<b>Length:</b>	0.5mm				

### Symbol Rules

Reference #:	Description:	Criteria:
PS-04250	<b>Embankment / with transportation (line)</b>	Embankment Type [FIC] = ( Dyke [3], Fill [2], Mound [1], Unknown [0])
	AND	Transportation System Type [TRS] = (Aeronautical [1], Aqueduct [2], Bus [4], Canal [5], Maritime [7], Pipeline [10], Railway [12], Road [13])

### Symbol Samples



Shown with road:



Shown with railway:



### Embankment / without transportation (line)



Symbol Graphic

**Symbol Placement Instructions:** The symbol is applied to the geometry of the feature.

**Symbol Type:** Complex

**Repeating Point and Interval:** Component P00067 has an initial offset of 0.75mm; after that 1.5mm.

**Note:** Component P00067 is perpendicular to and on the downhill side of Component L00240.

<b>Component Ref #:</b>	L00240	<b>Component Type:</b>	Line - Simple	<b>Color Token:</b>	Dk-Brown1815
<b>Description:</b>	Dk-Brown1815 0.15mm Solid Line				
<b>Parameters:</b>					
<b>Line Weight:</b>	0.15mm				
<b>Component Ref #:</b>	P00067	<b>Component Type:</b>	Point - Simple	<b>Color Token:</b>	Dk-Brown1815
<b>Description:</b>	Dk-Brown1815 0.8mm length line with a 0.15mm lineweight				
<b>Parameters:</b>					
<b>Line Weight:</b>	0.15mm				

Length: 0.8mm

Symbol Rules

Reference #:	Description:	Criteria:
<b>PS-04251</b>	<b>Embankment / without transportation (line)</b>	Embankment Type [FIC] = ( Dyke [3], Mound [1], Unknown [0])
	AND	ransportation System Type [TRS] = (Not Applicable [998], Other [999], Pedestrian [9], Unknown [0])

Symbol Samples



Engineered Earthwork (AH025)

Generalization Rules (see Annex J): GA-9999

Engineered Earthwork / all (line)



Symbol Graphic

Symbol Placement Instructions: The symbol is applied to the geometry of the feature.

Symbol Type: Simple

Component Ref #:	L00011	Component Type:	Line - Simple	Color Token:	Black
Description:	Black 0.3mm Solid Line				
Parameters:					
Line Weight:	0.3mm				

Symbol Rules

Reference #:	Description:	Criteria:
<b>PS-04508</b>	<b>Engineered Earthwork / all (line)</b>	All

Label Rules

Label Placement Rules (see Annex J): LP-3630, LP-9999

Reference #:	Description:	Criteria:
<b>PL-04508_1</b>	<b>Engineered Earthwork / other (line)</b>	Engineered Earthwork Type [EET] = (Battery [1], Rampart [4], Redoubt [5])
	Label String: [Engineered Earthwork Type]	
	Characteristics: 1	
	1 (Black, Condensed, 6 pt, Mixed case)	
<b>PL-04508_2</b>	<b>Engineered Earthwork / parapet (line)</b>	Engineered Earthwork Type [EET] = Military Parapet [2]
	Label String: "Parapet"	
	Characteristics: 1	
	1 (Black, Condensed, 6 pt, Mixed case)	
<b>PL-04508_3</b>	<b>Engineered Earthwork / trench (line)</b>	Engineered Earthwork Type [EET] = (Military Trench [3], Other [999], Unknown [0])
	Label String: "Trench"	
	Characteristics: 1	
	1 (Black, Condensed, 6 pt, Mixed case)	

Symbol Samples

Trench

Battery

## Entrance and/or Exit (AQ090)

### Entrance and/or Exit / all (point)



Symbol Graphic

Symbol Placement Instructions: Origin: Center of symbol

Symbol Type: Simple

Note: The baseline of the symbol is centered perpendicular to the end of the associated transportation feature, with the angled element facing towards the transportation feature.

Component Ref #:	P00073	Component Type:	Point - Shape	Color Token:	Black
Description:	Tunnel entrance not water				
Parameters:					
Note:	See Annex H for detailed drawing instructions.				

#### Symbol Rules

Reference #:	Description:	Criteria:
PS-04725	Entrance and/or Exit / all (point)	All

#### Symbol Samples



Shown with Road:



## Esker (DB100)

Generalization Rules (see Annex J): GA-9999

### Esker / all (line)



Symbol Graphic

Symbol Placement Instructions: The symbol is applied to the geometry of the feature.

Symbol Type: Simple

Component Ref #:	L00023	Component Type:	Line - Simple	Color Token:	Dk-Brown1815
Description:	Dk-Brown1815 0.2mm Solid Line				
Parameters:					
Line Weight:	0.2mm				

#### Symbol Rules

Reference #:	Description:	Criteria:
PS-04509	Esker / all (line)	All

#### Label Rules

Label Placement Rules (see Annex J): LP-3630

Reference #:	Description:	Criteria:
PL-04509_1	Esker / all (line)	N/A

Label String: "Esker"

Characteristics: 1  
1 (Black, Condensed, 6 pt, Mixed case)

Symbol Samples

Esker

**Extraction Mine (AA010)**

Generalization Rules (see Annex J): GA-9999, GC-9982

**Extraction Mine / intact / not peat (area)**



Symbol Graphic

Symbol Placement Instructions: The symbol is applied to the geometry of the feature.

Symbol Type: Complex

Note: Component L00210 is applied to the perimeter and Component P00001 is placed in the center.

Component Ref #:	L00210	Component Type:	Line - Styled	Color Token:	Black
Description:	Black 0.1mm Dashed line (0.1mm wt, 1.0mm dash, 0.5mm gap)				
Parameters:					
Line Weight:	0.1mm	Dash Length:	1.0mm	Dash Spacing:	0.5mm
Component Ref #:	P00001	Component Type:	Point - Shape	Color Token:	Black
Description:	Extraction mine intact not peat				
Parameters:					
Note:	See Annex H for detailed drawing instructions.				

Symbol Rules

Reference #:	Description:	Criteria:
PS-04266	Extraction Mine / intact / not peat (area)	Condition of Facility [FUN] = (Fully Functional [6], Unknown [0])
	AND	Extraction Mine Type [MZN] = (Area Strip-mine [6], Below Surface [9], Opencast [3], Placer [4], Prospect [5], Unknown[0])

Label Rules

Label Placement Rules (see Annex J): LP-3506, LP-4813, LP-9999

Reference #:	Description:	Criteria:
PL-04266_1	Extraction Mine / intact / not peat / named / type known / product known (area)	Name [NAM] <> Unknown
	AND	Extraction Mine Type [MZN] = (Opencast [3], Placer [4], Prospect [5], Area Strip-mine [6], Below Surface [9])
	AND	Product [PPO] = (Bauxite [9], Coal [18], Copper [26], Diamond [33], Gold [48], Iron [58], Lead [59], Manganese [65], Quartz [89], Salt [95], Silver [105], Uranium [120], Zinc [126])
	Label String:	[Name] "["[Extraction Mine Type]" "]" "["[Product]" "]"
	Characteristics:	1, 22, 22, 22, 22, 22, 22 1 (Black, Condensed, 6 pt, Mixed case) 22 (Black, Condensed, 6 pt, Lower case)
PL-04266_2	Extraction Mine / intact / not peat / named / type known / product unknown (area)	Name [NAM] <> Unknown
	AND	Extraction Mine Type [MZN] = (Opencast [3], Placer [4], Prospect [5], Area Strip-mine [6], Below Surface [9])

AND Product [PPO] = (Other [999], Unknown [0])

Label String: [Name] "["[Extraction Mine Type]"

Characteristics: 1, 22, 22, 22  
1 (Black, Condensed, 6 pt, Mixed case)  
22 (Black, Condensed, 6 pt, Lower case)**PL-04266\_3** Extraction Mine / intact / not peat / named / type  
unknown / product known (area)

Name [NAM] &lt;&gt; Unknown

AND Extraction Mine Type [MZN] = Unknown [0]

AND Product [PPO] = (Bauxite [9], Coal [18], Copper [26], Diamond [33], Gold [48],  
Iron [58], Lead [59], Manganese [65], Quartz [89], Salt [95], Silver [105], Uranium  
[120], Zinc [126])

Label String: [Name] "["[Product]"

Characteristics: 1, 22, 22, 22  
1 (Black, Condensed, 6 pt, Mixed case)  
22 (Black, Condensed, 6 pt, Lower case)**PL-04266\_4** Extraction Mine / intact / not peat / named / type  
unknown / product unknown (area)

Name [NAM] &lt;&gt; Unknown

AND Extraction Mine Type [MZN] = Unknown [0]

AND Product [PPO] = (Other [999], Unknown [0])

Label String: [Name]

Characteristics: 1  
1 (Black, Condensed, 6 pt, Mixed case)**PL-04266\_5** Extraction Mine / intact / not peat / unnamed / type  
known / product known (area)

Name [NAM] = Unknown

AND Extraction Mine Type [MZN] = (Opencast [3], Placer [4], Prospect [5], Area Strip-  
mine [6], Below Surface [9])AND Product [PPO] = (Bauxite [9], Coal [18], Copper [26], Diamond [33], Gold [48],  
Iron [58], Lead [59], Manganese [65], Quartz [89], Salt [95], Silver [105], Uranium  
[120], Zinc [126])

Label String: [Extraction Mine Type] "["[Product]"

Characteristics: 1, 22, 22, 22  
1 (Black, Condensed, 6 pt, Mixed case)  
22 (Black, Condensed, 6 pt, Lower case)**PL-04266\_6** Extraction Mine / intact / not peat / unnamed / type  
known / product unknown (area)

Name [NAM] = Unknown

AND Extraction Mine Type [MZN] = (Opencast [3], Placer [4], Prospect [5], Area Strip-  
mine [6], Below Surface [9])

AND Product [PPO] = (Other [999], Unknown [0])

Label String: [Extraction Mine Type]

Characteristics: 1  
1 (Black, Condensed, 6 pt, Mixed case)**PL-04266\_7** Extraction Mine / intact / not peat / unnamed / type  
unknown / product known (area)

Name [NAM] = Unknown

AND Extraction Mine Type [MZN] = Unknown [0]

AND Product [PPO] = (Bauxite [9], Coal [18], Copper [26], Diamond [33], Gold [48],  
Iron [58], Lead [59], Manganese [65], Quartz [89], Salt [95], Silver [105], Uranium  
[120], Zinc [126])

Label String: [Product]

Characteristics: 1  
1 (Black, Condensed, 6 pt, Mixed case)

## Symbol Samples

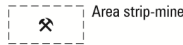

### Extraction Mine / not intact / not peat (area)



Symbol Graphic

**Symbol Placement Instructions:** The symbol is applied to the geometry of the feature.

**Symbol Type:** Complex

**Note:** Component L00210 is applied to the perimeter and Component P00002 is placed in the center.

<b>Component Ref #:</b>	L00210	<b>Component Type:</b>	Line - Styled	<b>Color Token:</b>	Black
<b>Description:</b>	Black 0.1mm Dashed line (0.1mm wt, 1.0mm dash, 0.5mm gap)				
<b>Parameters:</b>					
<b>Line Weight:</b>	0.1mm	<b>Dash Length:</b>	1.0mm	<b>Dash Spacing:</b>	0.5mm
<b>Component Ref #:</b>	P00002	<b>Component Type:</b>	Point - Shape	<b>Color Token:</b>	Black
<b>Description:</b>	Extraction mine not intact not peat				
<b>Parameters:</b>					
<b>Note:</b>	See Annex H for detailed drawing instructions.				

### Symbol Rules

Reference #:	Description:	Criteria:
<b>PS-04267</b>	<b>Extraction Mine / not intact / not peat (area)</b>	Condition of Facility [FUN] = (Abandoned [2], Damaged [13], Destroyed [3], Dismantled [4], Under Construction [1])
		AND Extraction Mine Type [MZN] = (Area Strip-mine [6], Below Surface [9], Opencast [3], Placer [4], Prospect [5], Unknown[0])

### Label Rules

Label Placement Rules (see Annex J): LP-3506, LP-4813, LP-9999

Reference #:	Description:	Criteria:
<b>PL-04267_1</b>	<b>Extraction Mine / not intact / not peat / named / type known / product known (area)</b>	Name [NAM] <> Unknown
		AND Extraction Mine Type [MZN] = (Opencast [3], Placer [4], Prospect [5], Area Strip-mine [6], Below Surface [9])
		AND Product [PPO] = (Bauxite [9], Coal [18], Copper [26], Diamond [33], Gold [48], Iron [58], Lead [59], Manganese [65], Quartz [89], Salt [95], Silver [105], Uranium [120], Zinc [126])
	<b>Label String:</b> [Name] "["[Extraction Mine Type]""] "["[Product]""]	
	<b>Characteristics:</b> 1, 22, 22, 22, 22, 22, 22 1 (Black, Condensed, 6 pt, Mixed case) 22 (Black, Condensed, 6 pt, Lower case)	
<b>PL-04267_2</b>	<b>Extraction Mine / not intact / not peat / named / type known / product unknown (area)</b>	Name [NAM] <> Unknown
		AND Extraction Mine Type [MZN] = (Opencast [3], Placer [4], Prospect [5], Area Strip-mine [6], Below Surface [9])
		AND Product [PPO] = (Other [999], Unknown [0])
	<b>Label String:</b> [Name] "["[Extraction Mine Type]""]	
	<b>Characteristics:</b> 1, 22, 22, 22 1 (Black, Condensed, 6 pt, Mixed case) 22 (Black, Condensed, 6 pt, Lower case)	
<b>PL-04267_3</b>	<b>Extraction Mine / not intact / not peat / named / type unknown / product known (area)</b>	Name [NAM] <> Unknown
		AND Extraction Mine Type [MZN] = Unknown [0]

AND Product [PPO] = (Bauxite [9], Coal [18], Copper [26], Diamond [33], Gold [48], Iron [58], Lead [59], Manganese [65], Quartz [89], Salt [95], Silver [105], Uranium [120], Zinc [126])

Label String: [Name] "["[Product]"]"  
 Characteristics: 1, 22, 22, 22  
 1 (Black, Condensed, 6 pt, Mixed case)  
 22 (Black, Condensed, 6 pt, Lower case)

**PL-04267\_4** Extraction Mine / not intact / not peat / named / type unknown / product unknown (area) Name [NAM] <> Unknown

AND Extraction Mine Type [MZN] = Unknown [0]

AND Product [PPO] = (Other [999], Unknown [0])

Label String: [Name]  
 Characteristics: 1  
 1 (Black, Condensed, 6 pt, Mixed case)

**PL-04267\_5** Extraction Mine / not intact / not peat / unnamed / type known / product known (area) Name [NAM] = Unknown

AND Extraction Mine Type [MZN] = (Opencast [3], Placer [4], Prospect [5], Area Strip-mine [6], Below Surface [9])

AND Product [PPO] = (Bauxite [9], Coal [18], Copper [26], Diamond [33], Gold [48], Iron [58], Lead [59], Manganese [65], Quartz [89], Salt [95], Silver [105], Uranium [120], Zinc [126])

Label String: [Extraction Mine Type] "["[Product]"]"  
 Characteristics: 1, 22, 22, 22  
 1 (Black, Condensed, 6 pt, Mixed case)  
 22 (Black, Condensed, 6 pt, Lower case)

**PL-04267\_6** Extraction Mine / not intact / not peat / unnamed / type known / product unknown (area) Name [NAM] = Unknown

AND Extraction Mine Type [MZN] = (Opencast [3], Placer [4], Prospect [5], Area Strip-mine [6], Below Surface [9])

AND Product [PPO] = (Other [999], Unknown [0])

Label String: [Extraction Mine Type]  
 Characteristics: 1  
 1 (Black, Condensed, 6 pt, Mixed case)

**PL-04267\_7** Extraction Mine / not intact / not peat / unnamed / type unknown / product known (area) Name [NAM] = Unknown

AND Extraction Mine Type [MZN] = Unknown [0]

AND Product [PPO] = (Bauxite [9], Coal [18], Copper [26], Diamond [33], Gold [48], Iron [58], Lead [59], Manganese [65], Quartz [89], Salt [95], Silver [105], Uranium [120], Zinc [126])

Label String: [Product]  
 Characteristics: 1  
 1 (Black, Condensed, 6 pt, Mixed case)

Symbol Samples

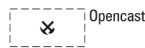

Extraction Mine / peat (area)



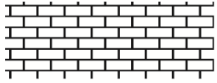

Symbol Graphic

Symbol Placement Instructions: The symbol is applied to the geometry of the feature.

Symbol Type: Simple

Component Ref #: A00001      Component Type: Area - Pattern      Color Token: Black  
 Description: Black Peat Fill  
Parameters:  
 Area Pattern: AP-129, see Annex I

**Symbol Rules**

Reference #: Description: Criteria:  
**PS-04268**    **Extraction Mine / peat (area)**      Extraction Mine Type [MZN] = Peatery [8]

**Label Rules**

Label Placement Rules (see Annex J): LP-3505

Reference #: Description: Criteria:  
**PL-04268\_1**    **Extraction Mine / peat (area)**      N/A

Label String: "Peat cuttings"  
 Characteristics: 1  
 1 (Black, Condensed, 6 pt, Mixed case)

**Symbol Samples**



**Extraction Mine / intact / not peat (point)**



Symbol Graphic

Symbol Placement Instructions: Origin: Center of symbol

Symbol Type: Simple

Component Ref #: P00001      Component Type: Point - Shape      Color Token: Black  
 Description: Extraction mine intact not peat  
Parameters:  
 Note: See Annex H for detailed drawing instructions.

**Symbol Rules**

Reference #: Description: Criteria:  
**PS-04269**    **Extraction Mine / intact / not peat (point)**      Condition of Facility [FUN] = (Fully Functional [6], Unknown [0])  
 AND      Extraction Mine Type [MZN] = (Area Strip-mine [6], Below Surface [9], Opencast [3], Placer [4], Prospect [5], Unknown[0])

**Label Rules**

Label Placement Rules (see Annex J): LP-3505, LP-4813, LP-9999

Reference #: Description: Criteria:  
**PL-04269\_1**    **Extraction Mine / intact / not peat / named / type known / product known (point)**      Name [NAM] <> Unknown  
 AND      Extraction Mine Type [MZN] = (Opencast [3], Placer [4], Prospect [5], Area Strip-mine [6], Below Surface [9])

AND Product [PPO] = (Bauxite [9], Coal [18], Copper [26], Diamond [33], Gold [48], Iron [58], Lead [59], Manganese [65], Quartz [89], Salt [95], Silver [105], Uranium [120], Zinc [126])

Label String: [Name] "["[Extraction Mine Type]" "]" "["[Product]" "]"

Characteristics: 1, 22, 22, 22, 22, 22, 22  
1 (Black, Condensed, 6 pt, Mixed case)  
22 (Black, Condensed, 6 pt, Lower case)

**PL-04269\_2** Extraction Mine / intact / not peat / named / type known / product unknown (point)

Name [NAM] <> Unknown

AND Extraction Mine Type [MZN] = (Opencast [3], Placer [4], Prospect [5], Area Strip-mine [6], Below Surface [9])

AND Product [PPO] = (Other [999], Unknown [0])

Label String: [Name] "["[Extraction Mine Type]" "]"

Characteristics: 1, 22, 22, 22  
1 (Black, Condensed, 6 pt, Mixed case)  
22 (Black, Condensed, 6 pt, Lower case)

**PL-04269\_3** Extraction Mine / intact / not peat / named / type unknown / product known (point)

Name [NAM] <> Unknown

AND Extraction Mine Type [MZN] = Unknown [0]

AND Product [PPO] = (Bauxite [9], Coal [18], Copper [26], Diamond [33], Gold [48], Iron [58], Lead [59], Manganese [65], Quartz [89], Salt [95], Silver [105], Uranium [120], Zinc [126])

Label String: [Name] "["[Product]" "]"

Characteristics: 1, 22, 22, 22  
1 (Black, Condensed, 6 pt, Mixed case)  
22 (Black, Condensed, 6 pt, Lower case)

**PL-04269\_4** Extraction Mine / intact / not peat / named / type unknown / product unknown (point)

Name [NAM] <> Unknown

AND Extraction Mine Type [MZN] = Unknown [0]

AND Product [PPO] = (Other [999], Unknown [0])

Label String: [Name]

Characteristics: 1  
1 (Black, Condensed, 6 pt, Mixed case)

**PL-04269\_5** Extraction Mine / intact / not peat / unnamed / type known / product known (point)

Name [NAM] = Unknown

AND Extraction Mine Type [MZN] = (Opencast [3], Placer [4], Prospect [5], Area Strip-mine [6], Below Surface [9])

AND Product [PPO] = (Bauxite [9], Coal [18], Copper [26], Diamond [33], Gold [48], Iron [58], Lead [59], Manganese [65], Quartz [89], Salt [95], Silver [105], Uranium [120], Zinc [126])

Label String: [Extraction Mine Type] "["[Product]" "]"

Characteristics: 1, 22, 22, 22  
1 (Black, Condensed, 6 pt, Mixed case)  
22 (Black, Condensed, 6 pt, Lower case)

**PL-04269\_6** Extraction Mine / intact / not peat / unnamed / type known / product unknown (point)

Name [NAM] = Unknown

AND Extraction Mine Type [MZN] = (Opencast [3], Placer [4], Prospect [5], Area Strip-mine [6], Below Surface [9])

AND Product [PPO] = (Other [999], Unknown [0])

Label String: [Extraction Mine Type]

Characteristics: 1  
1 (Black, Condensed, 6 pt, Mixed case)

**PL-04269\_7** Extraction Mine / intact / not peat / unnamed / type unknown / product known (point)

Name [NAM] = Unknown

AND Extraction Mine Type [MZN] = Unknown [0]

AND Product [PPO] = (Bauxite [9], Coal [18], Copper [26], Diamond [33], Gold [48], Iron [58], Lead [59], Manganese [65], Quartz [89], Salt [95], Silver [105], Uranium [120], Zinc [126])

Label String: [Product]  
 Characteristics: 1  
 1 (Black, Condensed, 6 pt, Mixed case)

Symbol Samples



Prospect

Coal

**Extraction Mine / not intact / not peat (point)**



Symbol Graphic

Symbol Placement Instructions: Origin: Center of symbol  
 Symbol Type: Simple

Component Ref #: P00002      Component Type: Point - Shape      Color Token: Black  
 Description: Extraction mine not intact not peat  
 Parameters:  
 Note: See Annex H for detailed drawing instructions.

Symbol Rules

Reference #: **PS-04270**      Description: **Extraction Mine / not intact / not peat (point)**      Criteria:  
 Condition of Facility [FUN] = (Abandoned [2], Damaged [13], Destroyed [3], Dismantled [4], Under Construction [1])  
 AND  
 Extraction Mine Type [MZN] = (Area Strip-mine [6], Below Surface [9], Opencast [3], Placer [4], Prospect [5], Unknown[0])

Label Rules

Label Placement Rules (see Annex J): LP-3505, LP-4813, LP-9999

Reference #: **PL-04270\_1**      Description: **Extraction Mine / not intact / not peat / named / type known / product known (point)**      Criteria:  
 Name [NAM] <> Unknown  
 AND Extraction Mine Type [MZN] = (Opencast [3], Placer [4], Prospect [5], Area Strip-mine [6], Below Surface [9])  
 AND Product [PPO] = (Bauxite [9], Coal [18], Copper [26], Diamond [33], Gold [48], Iron [58], Lead [59], Manganese [65], Quartz [89], Salt [95], Silver [105], Uranium [120], Zinc [126])  
 Label String: [Name] "["[Extraction Mine Type]" "]" "["[Product]" "]"  
 Characteristics: 1, 22, 22, 22, 22, 22, 22  
 1 (Black, Condensed, 6 pt, Mixed case)  
 22 (Black, Condensed, 6 pt, Lower case)

Reference #: **PL-04270\_2**      Description: **Extraction Mine / not intact / not peat / named / type known / product unknown (point)**      Criteria:  
 Name [NAM] <> Unknown  
 AND Extraction Mine Type [MZN] = (Opencast [3], Placer [4], Prospect [5], Area Strip-mine [6], Below Surface [9])

AND Product [PPO] = (Other [999], Unknown [0])

Label String: [Name] "["[Extraction Mine Type]""]

Characteristics: 1, 22, 22, 22  
1 (Black, Condensed, 6 pt, Mixed case)  
22 (Black, Condensed, 6 pt, Lower case)**PL-04270\_3** Extraction Mine / not intact / not peat / named / type unknown / product known (point)

Name [NAM] &lt;&gt; Unknown

AND Extraction Mine Type [MZN] = Unknown [0]

AND Product [PPO] = (Bauxite [9], Coal [18], Copper [26], Diamond [33], Gold [48], Iron [58], Lead [59], Manganese [65], Quartz [89], Salt [95], Silver [105], Uranium [120], Zinc [126])

Label String: [Name] "["[Product]""]

Characteristics: 1, 22, 22, 22  
1 (Black, Condensed, 6 pt, Mixed case)  
22 (Black, Condensed, 6 pt, Lower case)**PL-04270\_4** Extraction Mine / not intact / not peat / named / type unknown / product unknown (point)

Name [NAM] &lt;&gt; Unknown

AND Extraction Mine Type [MZN] = Unknown [0]

AND Product [PPO] = (Other [999], Unknown [0])

Label String: [Name]

Characteristics: 1  
1 (Black, Condensed, 6 pt, Mixed case)**PL-04270\_5** Extraction Mine / not intact / not peat / unnamed / type known / product known (point)

Name [NAM] = Unknown

AND Extraction Mine Type [MZN] = (Opencast [3], Placer [4], Prospect [5], Area Strip-mine [6], Below Surface [9])

AND Product [PPO] = (Bauxite [9], Coal [18], Copper [26], Diamond [33], Gold [48], Iron [58], Lead [59], Manganese [65], Quartz [89], Salt [95], Silver [105], Uranium [120], Zinc [126])

Label String: [Extraction Mine Type] "["[Product]""]

Characteristics: 1, 22, 22, 22  
1 (Black, Condensed, 6 pt, Mixed case)  
22 (Black, Condensed, 6 pt, Lower case)**PL-04270\_6** Extraction Mine / not intact / not peat / unnamed / type known / product unknown (point)

Name [NAM] = Unknown

AND Extraction Mine Type [MZN] = (Opencast [3], Placer [4], Prospect [5], Area Strip-mine [6], Below Surface [9])

AND Product [PPO] = (Other [999], Unknown [0])

Label String: [Extraction Mine Type]

Characteristics: 1  
1 (Black, Condensed, 6 pt, Mixed case)**PL-04270\_7** Extraction Mine / not intact / not peat / unnamed / type unknown / product known (point)

Name [NAM] = Unknown

AND Extraction Mine Type [MZN] = Unknown [0]

AND Product [PPO] = (Bauxite [9], Coal [18], Copper [26], Diamond [33], Gold [48], Iron [58], Lead [59], Manganese [65], Quartz [89], Salt [95], Silver [105], Uranium [120], Zinc [126])

Label String: [Product]

Characteristics: 1  
1 (Black, Condensed, 6 pt, Mixed case)

## Symbol Samples



## Extraction Mine / peat (point)

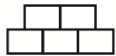

Symbol Graphic

Symbol Placement Instructions: Origin: Center of symbol

Symbol Type: Simple

Component Ref #:	P00084	Component Type:	Point - Shape	Color Token:	Black
Description:	Extraction mine peat				
Parameters:					
Note:	See Annex H for detailed drawing instructions.				

### Symbol Rules

Reference #:	Description:	Criteria:
PS-04271	Extraction Mine / peat (point)	Extraction Mine Type [MZN] = Peatery [8]

### Label Rules

Label Placement Rules (see Annex J): LP-3505

Reference #:	Description:	Criteria:
PL-04271_1	Extraction Mine / peat (point)	N/A

Label String: "Peat cuttings"  
 Characteristics: 1  
 1 (Black, Condensed, 6 pt, Mixed case)

### Symbol Samples

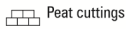

## Facility (AL010)

Generalization Rules (see Annex J): GA-9999, GC-9999

## Facility / all (area)



Symbol Graphic

Symbol Placement Instructions: The symbol is applied to the geometry of the feature.

Symbol Type: Simple

Component Ref #:	L00210	Component Type:	Line - Styled	Color Token:	Black
Description:	Black 0.1mm Dashed line (0.1mm wt, 1.0mm dash, 0.5mm gap)				
Parameters:					
Line Weight:	0.1mm	Dash Length:	1.0mm	Dash Spacing:	0.5mm

### Symbol Rules

Reference #:	Description:	Criteria:
PS-04280	Facility / all (area)	All

### Label Rules

Label Placement Rules (see Annex J): LP-3506, LP-4813, LP-9950, LP-9999

Reference #:	Description:	Criteria:
<b>PL-04280_1</b>	<b>Facility / intact / important (area)</b>	Condition of Facility [FUN] = (Fully Functional [6], Unknown [0])
		AND Feature Function [FFN] = (Botanical and/or Zoological Reserve Activities [907], Diplomacy [825], Education [850], Government [811], Human Health Activities [860], Manufacturing [99], Religious Activities [930], Telecommunications [610], Transport [480], Utilities [350])
	Label String: [Name] [Feature Function] Characteristics: 1, 1 1 (Black, Condensed, 6 pt, Mixed case)	
<b>PL-04280_2</b>	<b>Facility / intact / military (area)</b>	Condition of Facility [FUN] = (Fully Functional [6], Unknown [0])
		AND Feature Function [FFN] = Defence Activities [835]
	Label String: [Name] "Military" Characteristics: 1, 1 1 (Black, Condensed, 6 pt, Mixed case)	
<b>PL-04280_3</b>	<b>Facility / intact / prison (area)</b>	Condition of Facility [FUN] = (Fully Functional [6], Unknown [0])
		AND Feature Function [FFN] = Imprisonment [843]
	Label String: [Name] "Prison" Characteristics: 1, 1 1 (Black, Condensed, 6 pt, Mixed case)	
<b>PL-04280_4</b>	<b>Facility / intact / other (area)</b>	Condition of Facility [FUN] = (Fully Functional [6], Unknown [0])
		AND Feature Function [FFN] = (Accommodation [550], Administration [810], Agriculture [2], Commerce [440], Other [999], Residence [563], Sports Centre [912], Unknown [0])
	Label String: [Name] Characteristics: 1 1 (Black, Condensed, 6 pt, Mixed case)	
<b>PL-04280_5</b>	<b>Facility / not intact / important (area)</b>	Condition of Facility [FUN] = (Abandoned [2], Damaged [13], Destroyed [3], Dismantled [4], Under Construction [1])
		AND Feature Function [FFN] = (Botanical and/or Zoological Reserve Activities [907], Diplomacy [825], Education [850], Government [811], Human Health Activities [860], Manufacturing [99], Religious Activities [930], Telecommunications [610], Transport [480], Utilities [350])
	Label String: [Name] [Feature Function] "["[Condition of Facility]""] Characteristics: 1, 1, 22, 22, 22 1 (Black, Condensed, 6 pt, Mixed case) 22 (Black, Condensed, 6 pt, Lower case)	
<b>PL-04280_6</b>	<b>Facility / not intact / military (area)</b>	Condition of Facility [FUN] = (Abandoned [2], Damaged [13], Destroyed [3], Dismantled [4], Under Construction [1])
		AND Feature Function [FFN] = Defence Activities [835]
	Label String: [Name] "Military" "["[Condition of Facility]""] Characteristics: 1, 1, 22, 22, 22 1 (Black, Condensed, 6 pt, Mixed case) 22 (Black, Condensed, 6 pt, Lower case)	
<b>PL-04280_7</b>	<b>Facility / not intact / prison (area)</b>	Condition of Facility [FUN] = (Abandoned [2], Damaged [13], Destroyed [3], Dismantled [4], Under Construction [1])
		AND Feature Function [FFN] = Imprisonment [843]
	Label String: [Name] "Prison" "["[Condition of Facility]""] Characteristics: 1, 1, 22, 22, 22 1 (Black, Condensed, 6 pt, Mixed case) 22 (Black, Condensed, 6 pt, Lower case)	

**PL-04280\_8 Facility / not intact / other (area)**

Condition of Facility [FUN] = (Abandoned [2], Damaged [13], Destroyed [3], Dismantled [4], Under Construction [1])

AND Feature Function [FFN] = (Accommodation [550], Administration [810], Agriculture [2], Commerce [440], Other [999], Residence [563], Sports Centre [912], Unknown [0])

**Label String:** [Name] "["[Condition of Facility]"  
**Characteristics:** 1, 22, 22, 22  
 1 (Black, Condensed, 6 pt, Mixed case)  
 22 (Black, Condensed, 6 pt, Lower case)

**Symbol Samples**

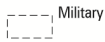

Military



York Manufacturing

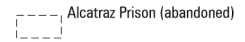

Alcatraz Prison (abandoned)

**Facility / intact (point)**



Symbol Graphic

**Symbol Placement Instructions:** Origin: Center of symbol  
**Symbol Type:** Simple

<b>Component Ref #:</b>	P00006	<b>Component Type:</b>	Point - Simple	<b>Color Token:</b>	Black
<b>Description:</b>	Black filled square with all sides 0.8mm				
<b>Parameters:</b>					
<b>Length:</b>	0.8mm				
<b>Note:</b>	The component is a square and is filled with the solid color.				

**Symbol Rules**

<b>Reference #:</b>	<b>Description:</b>	<b>Criteria:</b>
PS-04286	Facility / intact (point)	Condition of Facility [FUN] = (Fully Functional [6], Unknown [0])

**Label Rules**

**Label Placement Rules (see Annex J):** LP-3505, LP-4813, LP-9999

<b>Reference #:</b>	<b>Description:</b>	<b>Criteria:</b>
PL-04286_1	Facility / intact / important (point)	Feature Function [FFN] = (Botanical and/or Zoological Reserve Activities [907], Diplomacy [825], Education [850], Government [811], Human Health Activities [860], Manufacturing [99], Religious Activities [930], Telecommunications [610], Transport [480], Utilities [350])
	<b>Label String:</b> [Name] [Feature Function]	
	<b>Characteristics:</b> 1, 1 1 (Black, Condensed, 6 pt, Mixed case)	
PL-04286_2	Facility / intact / military (point)	Feature Function [FFN] = Defence Activities [835]
	<b>Label String:</b> [Name] "Military"	
	<b>Characteristics:</b> 1, 1 1 (Black, Condensed, 6 pt, Mixed case)	
PL-04286_3	Facility / intact / prison (point)	Feature Function [FFN] = Imprisonment [843]
	<b>Label String:</b> [Name] "Prison"	
	<b>Characteristics:</b> 1, 1 1 (Black, Condensed, 6 pt, Mixed case)	

**PL-04286\_4 Facility / intact / other (point)**

Feature Function [FFN] = (Accommodation [550], Administration [810], Agriculture [2], Commerce [440], Other [999], Residence [563], Sports Centre [912], Unknown [0])

Label String: [Name]  
 Characteristics: 1  
 1 (Black, Condensed, 6 pt, Mixed case)

Symbol Samples



**Facility / not intact (point)**



Symbol Graphic

Symbol Placement Instructions: Origin: Center of symbol  
 Symbol Type: Simple

Component Ref #: P00173      Component Type: Point - Shape      Color Token: Black/Black-12  
 Description: Not intact square 0.8mm  
Parameters:  
 Note: See Annex H for detailed drawing instructions.

Symbol Rules

Reference #: PS-04291      Description: Facility / not intact (point)      Criteria: Condition of Facility [FUN] = (Abandoned [2], Damaged [13], Destroyed [3], Dismantled [4], Under Construction [1])

Label Rules

Label Placement Rules (see Annex J): LP-3505, LP-4813, LP-9999

Reference #: PL-04291\_1      Description: Facility / not intact / important (point)      Criteria: Feature Function [FFN] = (Botanical and/or Zoological Reserve Activities [907], Diplomacy [825], Education [850], Government [811], Human Health Activities [860], Manufacturing [99], Religious Activities [930], Telecommunications [610], Transport [480], Utilities [350])

Label String: [Name] [Feature Function]  
 Characteristics: 1, 1  
 1 (Black, Condensed, 6 pt, Mixed case)

PL-04291\_2      Facility / not intact / military (point)      Feature Function [FFN] = Defence Activities [835]

Label String: [Name] "Military"  
 Characteristics: 1, 1  
 1 (Black, Condensed, 6 pt, Mixed case)

PL-04291\_3      Facility / not intact / prison (point)      Feature Function [FFN] = Imprisonment [843]

Label String: [Name] "Prison"  
 Characteristics: 1, 1  
 1 (Black, Condensed, 6 pt, Mixed case)

PL-04291\_4      Facility / not intact / other (point)      Feature Function [FFN] = (Accommodation [550], Administration [810], Agriculture [2], Commerce [440], Other [999], Residence [563], Sports Centre [912], Unknown [0])

Label String: [Name]  
 Characteristics: 1  
 1 (Black, Condensed, 6 pt, Mixed case)

Symbol Samples



Transport

## Fairground (AK090)

Generalization Rules (see Annex J): GA-9999, GC-9999

### Fairground / all (area)



Symbol Graphic

Symbol Placement Instructions: The symbol is applied to the geometry of the feature.

Symbol Type: Simple

Component Ref #:	L00210	Component Type:	Line - Styled	Color Token:	Black
Description:	Black 0.1mm Dashed line (0.1mm wt, 1.0mm dash, 0.5mm gap)				
Parameters:					
Line Weight:	0.1mm	Dash Length:	1.0mm	Dash Spacing:	0.5mm

#### Symbol Rules

Reference #:	Description:	Criteria:
PS-04057	Fairground / all (area)	All

#### Label Rules

Label Placement Rules (see Annex J): LP-3506, LP-4813, LP-9999

Reference #:	Description:	Criteria:
PL-04057_1	Fairground / intact (area)	N/A

Label String: [Name] "Fairgrounds"  
 Characteristics: 1, 1  
 1 (Black, Condensed, 6 pt, Mixed case)

#### Symbol Samples

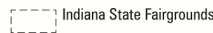

### Fairground / all (point)



Symbol Graphic

Symbol Placement Instructions: Origin: Center of symbol

Symbol Type: Simple

Component Ref #:	P00006	Component Type:	Point - Simple	Color Token:	Black
Description:	Black filled square with all sides 0.8mm				
Parameters:					
Length:	0.8mm				
Note:	The component is a square and is filled with the solid color.				

#### Symbol Rules

Reference #:	Description:	Criteria:
PS-04510	Fairground / all (point)	All

Label Rules

Label Placement Rules (see Annex J): LP-3505, LP-4813, LP-9999

Reference #: Description: Criteria:  
**PL-04510\_1** Fairground / intact (point) N/A

Label String: [Name] "Fairgrounds"  
 Characteristics: 1, 1  
 1 (Black, Condensed, 6 pt, Mixed case)

Symbol Samples



Fence (AL070)

Generalization Rules (see Annex J): GA-9999

Fence / all (line)

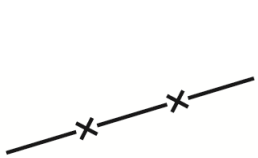

Symbol Graphic

Symbol Placement Instructions: The symbol is applied to the geometry of the feature.

Symbol Type: Complex

Note: Repeating pattern is Component L00442 followed by Component P00286 centered within each gap.

Component Ref #:	L00442	Component Type:	Line - Styled	Color Token:	Black
Description:	Black 0.15mm Dashed Line (0.15mm wt, 3.0mm dash, 1.0mm gap)				
Parameters:					
Line Weight:	0.15mm	Dash Length:	3.0mm	Dash Spacing:	1.0mm
Component Ref #:	P00286	Component Type:	Point - Shape	Color Token:	Black
Description:	Fence "X"				
Parameters:					
Note:	See Annex H for detailed drawing instructions.				

Symbol Rules

Reference #: Description: Criteria:  
**PS-04084** Fence / all (line) All

Symbol Samples



Ferry Crossing (AQ070)

Generalization Rules (see Annex J): GA-9999, GC-9991

Ferry Crossing / all (line)

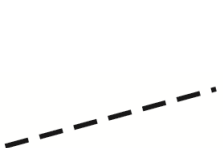

Symbol Graphic

Symbol Placement Instructions: The symbol is applied to the geometry of the feature.

Symbol Type: Simple

Component Ref #:	L00031	Component Type:	Line - Styled	Color Token:	Black
Description:	Black 0.2mm Dashed Line (0.2mm wt, 1.0mm dash, 0.5mm gap)				
Parameters:					
Line Weight:	0.2mm	Dash Length:	1.0mm	Dash Spacing:	0.5mm

Symbol Rules

Reference #:	Description:	Criteria:
PS-04137	Ferry Crossing / all (line)	All

Label Rules

Label Placement Rules (see Annex J): LP-3630, LP-4813, LP-9999

Reference #:	Description:	Criteria:
PL-04137_1	Ferry Crossing / all (line)	N/A

Label String: [Name] [Transportation System Type] "Ferry"  
 Characteristics: 1, 1, 1  
 1 (Black, Condensed, 6 pt, Mixed case)

Symbol Samples



Ferry Crossing / all (point)

Symbol Placement Instructions: Text label only. No graphic parameters  
 Symbol Type: Simple

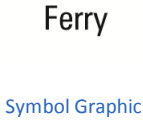

Symbol Rules

Reference #:	Description:	Criteria:
PS-04531	Ferry Crossing / all (point)	All

Label Rules

Label Placement Rules (see Annex J): LP-3505, LP-4813, LP-9999

Reference #:	Description:	Criteria:
PL-04531_1	Ferry Crossing / all (point)	N/A

Label String: [Name] [Transportation System Type] "Ferry"  
 Characteristics: 1, 1, 1  
 1 (Black, Condensed, 6 pt, Mixed case)

Symbol Samples

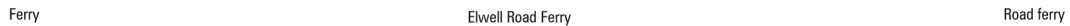

Firing Range (FA015)

Generalization Rules (see Annex J): GA-9999, GC-9999

Firing Range / all (area)



Symbol Graphic

Symbol Placement Instructions: The symbol is applied to the geometry of the feature.

Symbol Type: Simple

Component Ref #:	L00210	Component Type:	Line - Styled	Color Token:	Black
Description:	Black 0.1mm Dashed line (0.1mm wt, 1.0mm dash, 0.5mm gap)				
<u>Parameters:</u>					
Line Weight:	0.1mm	Dash Length:	1.0mm	Dash Spacing:	0.5mm

Symbol Rules

Reference #:	Description:	Criteria:
PS-04532	Firing Range / all (area)	All

Label Rules

Label Placement Rules (see Annex J): LP-3506, LP-4813, LP-9950, LP-9999

Reference #:	Description:	Criteria:
PL-04532_1	Firing Range / intact (area)	Condition of Facility [FUN] = (Fully Functional [6], Unknown [0])

Label String: [Name] "Firing range"  
 Characteristics: 1, 1  
 1 (Black, Condensed, 6 pt, Mixed case)

Reference #:	Description:	Criteria:
PL-04532_2	Firing Range / not intact (area)	Condition of Facility [FUN] = (Abandoned [2], Damaged [13], Destroyed [3], Dismantled [4], Under Construction [1])

Label String: [Name] "Firing range" "["[Condition of Facility]""]"  
 Characteristics: 1, 1, 22, 22, 22  
 1 (Black, Condensed, 6 pt, Mixed case)  
 22 (Black, Condensed, 6 pt, Lower case)

Symbol Samples



Firing Range / all (point)



Symbol Graphic

Symbol Placement Instructions: Origin: Center of symbol

Symbol Type: Simple

Component Ref #:	P00010	Component Type:	Point - Shape	Color Token:	Black
Description:	Located object				
<u>Parameters:</u>					
Note:	See Annex H for detailed drawing instructions.				

Symbol Rules

Reference #:	Description:	Criteria:
PS-04838	Firing Range / all (point)	All

Label Rules

Label Placement Rules (see Annex J): LP-3505, LP-4813, LP-9999

Reference #:	Description:	Criteria:
PL-04838_1	Firing Range / all (point)	N/A

Label String: [Name] "Firing range"

Characteristics: 1, 1  
1 (Black, Condensed, 6 pt, Mixed case)

Symbol Samples

Firing range

Blackhawk Firing Range

**Fish Farm Facility (BH051)**

Generalization Rules (see Annex J): GA-9999, GC-9999

**Fish Farm Facility / all (area)**



Symbol Graphic

Symbol Placement Instructions: The symbol is applied to the geometry of the feature.

Symbol Type: Simple

Component Ref #:	L00210	Component Type:	Line - Styled	Color Token:	Black
Description:	Black 0.1mm Dashed line (0.1mm wt, 1.0mm dash, 0.5mm gap)				
Parameters:					
Line Weight:	0.1mm	Dash Length:	1.0mm	Dash Spacing:	0.5mm

Symbol Rules

Reference #:	Description:	Criteria:
PS-04184	Fish Farm Facility / all (area)	All

Label Rules

Label Placement Rules (see Annex J): LP-3506, LP-4813, LP-9950, LP-9999

Reference #:	Description:	Criteria:
PL-04184_1	Fish Farm Facility / intact (area)	Condition of Facility [FUN] = (Fully Functional [6], Unknown [0])

Label String: [Name] "Fish farm"  
Characteristics: 1, 1  
1 (Black, Condensed, 6 pt, Mixed case)

Reference #:	Description:	Criteria:
PL-04184_2	Fish Farm Facility / not intact (area)	Condition of Facility [FUN] = (Abandoned [2], Damaged [13], Destroyed [3], Dismantled [4], Under Construction [1])

Label String: [Name] "Fish farm" ("[Condition of Facility]")  
Characteristics: 1, 1, 22, 22, 22  
1 (Black, Condensed, 6 pt, Mixed case)  
22 (Black, Condensed, 6 pt, Lower case)

Symbol Samples

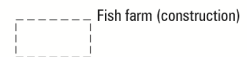
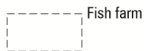

**Fish Farm Facility / intact (point)**



Symbol Graphic

Symbol Placement Instructions: Origin: Center of symbol

Symbol Type: Simple

Component Ref #: P00006      Component Type: Point - Simple      Color Token: Black  
 Description: Black filled square with all sides 0.8mm  
Parameters:  
 Length: 0.8mm  
 Note: The component is a square and is filled with the solid color.

Symbol Rules

Reference #: Description: Criteria:  
**PS-04530** Fish Farm Facility / intact (point) Condition of Facility [FUN] = (Fully Functional [6], Unknown [0])

Label Rules

Label Placement Rules (see Annex J): LP-3505, LP-4813, LP-9999

Reference #: Description: Criteria:  
**PL-04530\_1** Fish Farm Facility / intact (point) N/A

Label String: [Name] "Fish farm"  
 Characteristics: 1, 1  
 1 (Black, Condensed, 6 pt, Mixed case)

Symbol Samples



Fish Farm Facility / not intact (point)



Symbol Graphic

Symbol Placement Instructions: Origin: Center of symbol  
 Symbol Type: Simple

Component Ref #: P00173      Component Type: Point - Shape      Color Token: Black/Black-12  
 Description: Not intact square 0.8mm  
Parameters:  
 Note: See Annex H for detailed drawing instructions.

Symbol Rules

Reference #: Description: Criteria:  
**PS-04673** Fish Farm Facility / not intact (point) Condition of Facility [FUN] = (Abandoned [2], Damaged [13], Destroyed [3], Dismantled [4], Under Construction [1])

Label Rules

Label Placement Rules (see Annex J): LP-3505

Reference #: Description: Criteria:  
**PL-04673\_1** Fish Farm Facility / not intact (point) N/A

Label String: "Fish farm"  
 Characteristics: 1  
 1 (Black, Condensed, 6 pt, Mixed case)

Symbol Samples



## Flare Pipe (AF070)

### Flare Pipe / non-obstruction (point)



Symbol Graphic

Symbol Placement Instructions: Origin: Center of open circle

Symbol Type: Simple

Component Ref #: P00145      Component Type: Point - Shape      Color Token: Black  
 Description: Flare pipe  
Parameters:  
 Note: See Annex H for detailed drawing instructions.

#### Symbol Rules

Reference #: Description: Criteria:  
**PS-04041**    **Flare Pipe / non-obstruction (point)**      Height Above Surface Level [HGT] < 46

#### Symbol Samples



## Flume (BH060)

Generalization Rules (see Annex J): GA-9999

### Flume / on surface (line)



Symbol Graphic

Symbol Placement Instructions: The symbol is applied to the geometry of the feature.

Symbol Type: Simple

Component Ref #: L00016      Component Type: Line - Simple      Color Token: Cyan  
 Description: Cyan 0.3mm Solid Line  
Parameters:  
 Line Weight: 0.3mm

#### Symbol Rules

Reference #: Description: Criteria:  
**PS-04773**    **Flume / on surface (line)**      Vertical Relative Location [LOC] = (On Surface [44], Unknown [0])

#### Label Rules

Label Placement Rules (see Annex J): LP-3630

Reference #: Description: Criteria:  
**PL-04773\_1**    **Flume / on surface (line)**      N/A

Label String: "Flume"  
 Characteristics: 16  
 16 (Cyan, Condensed, Italic, 6 pt, Mixed case)

#### Symbol Samples

*Flume*

## Flume / below surface (line)

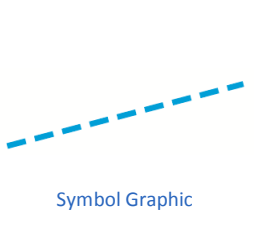

Symbol Placement Instructions: The symbol is applied to the geometry of the feature.

Symbol Type: Simple

Component Ref #:	L00235	Component Type:	Line - Styled	Color Token:	Cyan
Description:	Cyan 0.3mm Dashed Line (0.3mm wt, 1.0mm dash, 0.5mm gap)				
<u>Parameters:</u>					
Line Weight:	0.3mm	Dash Length:	1.0mm	Dash Spacing:	0.5mm

### Symbol Rules

Reference #:	Description:	Criteria:
PS-04774	Flume / below surface (line)	Vertical Relative Location [LOC] = Below Ground Surface [40]

### Label Rules

Label Placement Rules (see Annex J): LP-3630

Reference #:	Description:	Criteria:
PL-04774_1	Flume / below surface (line)	N/A

Label String: "Flume"  
 Characteristics: 16  
 16 (Cyan, Condensed, Italic, 6 pt, Mixed case)

### Symbol Samples

*Flume*

## Ford (BH070)

Generalization Rules (see Annex J): GA-9999, GC-9986

## Ford / all (point)

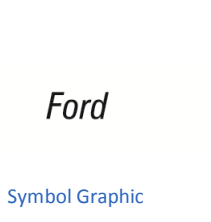

Symbol Placement Instructions: Text label only. No graphic parameters

Symbol Type: Simple

### Symbol Rules

Reference #:	Description:	Criteria:
PS-04186	Ford / all (point)	All

### Label Rules

Label Placement Rules (see Annex J): LP-3505

Reference #:	Description:	Criteria:
PL-04186_1	Ford / all (point)	N/A



Label String: "Ford"  
 Characteristics: 5  
 5 (Black, Condensed,Italic, 6 pt, Mixed case)

Symbol Samples



Forest Clearing (EC060)

Generalization Rules (see Annex J): GA-9999

Forest Clearing / all (area)

{NO SYMBOL}

Symbol Graphic

Symbol Placement Instructions: The symbol is applied to the geometry of the feature.

Symbol Type: Simple

Note: The symbol is a mask of the Thicket (EB020) and Wood (EC030) feature symbols.

Symbol Rules

Reference #:	Description:	Criteria:
PS-04852	Forest Clearing / all (area)	All

Symbol Samples

{NO SYMBOL}

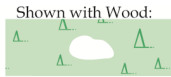

Fortification (AH050)

Generalization Rules (see Annex J): GA-9999, GC-9982, GC-9983

Fortification / all (area)

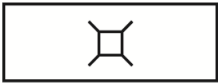

Symbol Graphic

Symbol Placement Instructions: The symbol is applied to the geometry of the feature.

Symbol Type: Complex

Note: Component L00009 is applied to the perimeter and Component P00108 is placed in the center.

Component Ref #:	L00009	Component Type:	Line - Simple	Color Token:	Black
Description:	Black 0.2mm Solid Line				
Parameters:					
Line Weight:	0.2mm				
Component Ref #:	P00108	Component Type:	Point - Shape	Color Token:	Black
Description:	Fortified building				
Parameters:					
Note:	See Annex H for detailed drawing instructions.				

Symbol Rules

Reference #:	Description:	Criteria:
PS-04046	Fortification / all (area)	Height Above Surface Level [HGT] < 46

Label Rules

Label Placement Rules (see Annex J): LP-3506, LP-9950, LP-9999

Reference #: Description:

Criteria:

**PL-04046\_1 Fortification / intact (area)**

Condition of Facility [FUN] = (Fully Functional [6], Unknown [0])

Label String: [Name]

Characteristics: 1  
1 (Black, Condensed, 6 pt, Mixed case)

**PL-04046\_2 Fortification / not intact (area)**

Condition of Facility [FUN] = (Abandoned [2], Damaged [13], Destroyed [3], Dismantled [4], Under Construction [1])

Label String: [Name] "["[Condition of Facility]"

Characteristics: 1, 22, 22, 22  
1 (Black, Condensed, 6 pt, Mixed case)  
22 (Black, Condensed, 6 pt, Lower case)

Symbol Samples



Fortification / all (point)



Symbol Graphic

Symbol Placement Instructions: Origin: Center of symbol

Symbol Type: Simple

Component Ref #:	P00108	Component Type:	Point - Shape	Color Token:	Black
Description:	Fortified building				
Parameters:					
Note:	See Annex H for detailed drawing instructions.				

Symbol Rules

Reference #: Description:

Criteria:

**PS-04047 Fortification / all (point)**

Height Above Surface Level [HGT] < 46

Label Rules

Label Placement Rules (see Annex J): LP-3505, LP-9950, LP-9999

Reference #: Description:

Criteria:

**PL-04047\_1 Fortification / intact (point)**

Condition of Facility [FUN] = (Fully Functional [6], Unknown [0])

Label String: [Name]

Characteristics: 1  
1 (Black, Condensed, 6 pt, Mixed case)

**PL-04047\_2 Fortification / not intact (point)**

Condition of Facility [FUN] = (Abandoned [2], Damaged [13], Destroyed [3], Dismantled [4], Under Construction [1])

Label String: [Name] "["[Condition of Facility]"

Characteristics: 1, 22, 22, 22  
1 (Black, Condensed, 6 pt, Mixed case)  
22 (Black, Condensed, 6 pt, Lower case)

Symbol Samples



## General Building (AL015)

Generalization Rules (see Annex J): GA-9999, GC-9978, GC-9983, GC-9994

### General Building / non-obstruction / intact / generic or important (area)

 Symbol Graphic	Symbol Placement Instructions: The symbol is applied to the geometry of the feature.
	Symbol Type: Simple

Component Ref #:	A00006	Component Type:	Area - Fill	Color Token:	Black
Description:	Black solid fill				
Parameters:					
Note:	The surface geometry is filled with the solid color.				

### Symbol Rules

Reference #:	Description:	Criteria:
PS-04680	<b>General Building / non-obstruction / intact / generic or important (area)</b>	Height Above Surface Level [HGT] < 46
	AND	Condition of Facility [FUN] = (Fully Functional [6], Unknown [0])
	AND	Feature Function [FFN] = (Accommodation [550], Administration [810], Agriculture [2], Aircraft Repair [341], Animal Boarding [919], Auditorium [892], Commerce [440], Community Centre [893], Cooling [355], Defence Activities [835], Firefighting [845], General Repair [330], Government [811], Grain Milling [107], Guard [781], Harbour Control [513], Imprisonment [843], Institution [859], Law Enforcement [841], Library [902], Manufacturing [99], Maritime Pilotage [511], Market [475], Motor Vehicle Manufacture [290], Motor Vehicle Parking [535], Motor Vehicle Repair [343], Museum [905], Observation Station [721], Oil-mill [105], Opera House [894], Other [999], Palace [815], Paper-mill [171], Petroleum Refining [192], Postal Activities [540], Power Generation [351], Print Publishing [582], Pumping [501], Radio Broadcasting [601], Residence [563], Restaurant [572], Retail Banking [643], Satellite Ground Control [626], Sawmilling [161], Scientific Research and Development [720], Signalling [486], Social Work [887], Sports Centre [912], Steel Mill [241], Telecommunications [610], Television Broadcasting [604], Terminal [481], Theatre [891], Transport [480], Unknown [0], Utilities [350], Warehousing and Storage [530], Water Treatment [362], Weather Station [722], Wind Tunnel [730], Yacht-club [955])

### Label Rules

Label Placement Rules (see Annex J): LP-3505, LP-4813, LP-9999

Reference #:	Description:	Criteria:
PL-04680_1	<b>General Building / non-obstruction / intact / generic or important / other (area)</b>	Feature Function [FFN] = (Auditorium [892], Firefighting [845], Government [811], Grain Milling [107], Library [902], Motor Vehicle Manufacture [290], Museum [905], Observation Station [721], Oil-mill [105], Opera House [894], Palace [815], Paper-mill [171], Petroleum Refining [192], Sawmilling [161], Sports Centre [912], Steel Mill [241], Terminal [481], Theatre [891], Weather Station [722], Wind Tunnel [730], Yacht-club [955])
	Label String: [Name] [Feature Function]	
	Characteristics: 1, 1 1 (Black, Condensed, 6 pt, Mixed case)	
PL-04680_2	<b>General Building / non-obstruction / intact / generic or important / military (area)</b>	Feature Function [FFN] = Defence Activities [835]
	Label String: [Name] "Military"	
	Characteristics: 1, 1 1 (Black, Condensed, 6 pt, Mixed case)	
PL-04680_3	<b>General Building / non-obstruction / intact / generic or important / police (area)</b>	Feature Function [FFN] = Law Enforcement [841]
	Label String: [Name] "Police"	
	Characteristics: 1, 1 1 (Black, Condensed, 6 pt, Mixed case)	
PL-04680_4	<b>General Building / non-obstruction / intact / generic or important / prison (area)</b>	Feature Function [FFN] = Imprisonment [843]
	Label String: [Name] "Prison"	
	Characteristics: 1, 1 1 (Black, Condensed, 6 pt, Mixed case)	

Symbol Samples

Metropolitan Museum of Art

Prison

General Building / non-obstruction / intact / christian (area)



Symbol Graphic

Symbol Placement Instructions: The symbol is applied to the geometry of the feature.

Symbol Type: Complex

Note: The base of Component P00013 is placed perpendicular to and centered along the northernmost edge of Component A00006.

Component Ref #:	A00006	Component Type:	Area - Fill	Color Token:	Black
Description:	Black solid fill				
Parameters:					
Note:	The surface geometry is filled with the solid color.				

Component Ref #:	P00013	Component Type:	Point - Shape	Color Token:	Black
Description:	Building Christian cross				
Parameters:					
Note:	See Annex H for detailed drawing instructions.				

Symbol Rules

Reference #:	Description:	Criteria:
PS-04681	General Building / non-obstruction / intact / christian (area)	Height Above Surface Level [HGT] < 46
		AND Condition of Facility [FUN] = (Fully Functional [6], Unknown [0])
		AND Feature Function [FFN] = (Place of Worship [931], Religious Activities [930])
		AND House of Worship Type [HWT] = (Cathedral [2], Chapel [3], Church [4], Tabernacle [15])

Label Rules

Label Placement Rules (see Annex J): LP-3505, LP-9999

Reference #:	Description:	Criteria:
PL-04681_1	General Building / non-obstruction / intact / christian (area)	N/A
	Label String: [Name]	
	Characteristics: 1	
	1 (Black, Condensed, 6 pt, Mixed case)	

Symbol Samples



St. Francis Xavier

General Building / non-obstruction / intact / islam (area)



Symbol Graphic

Symbol Placement Instructions: The symbol is applied to the geometry of the feature.

Symbol Type: Complex

Note: The base of Component P00014 is placed perpendicular to and centered along the northernmost edge of Component A00006.

Component Ref #: A00006      Component Type: Area - Fill      Color Token: Black  
 Description: Black solid fill  
Parameters:  
 Note: The surface geometry is filled with the solid color.

Component Ref #: P00014      Component Type: Point - Shape      Color Token: Black  
 Description: Building Islamic crescent  
Parameters:  
 Note: See Annex H for detailed drawing instructions.

**Symbol Rules**

Reference #: **PS-04682**      Description: **General Building / non-obstruction / intact / islam (area)**      Criteria:  
 Height Above Surface Level [HGT] < 46  
 AND Condition of Facility [FUN] = (Fully Functional [6], Unknown [0])  
 AND Feature Function [FFN] = (Place of Worship [931], Religious Activities [930])  
 AND House of Worship Type [HWT] = (Marabout [5], Minaret [6], Mosque [9])

**Label Rules**

Label Placement Rules (see Annex J): LP-3505, LP-9999

Reference #: **PL-04682\_1**      Description: **General Building / non-obstruction / intact / islam (area)**      Criteria: N/A

Label String: [Name]  
 Characteristics: 1  
 1 (Black, Condensed, 6 pt, Mixed case)

**Symbol Samples**



**General Building / non-obstruction / intact / pagoda (area)**



Symbol Graphic

Symbol Placement Instructions: The symbol is applied to the geometry of the feature.

Symbol Type: Complex

Note: The base of Component P00019 is placed perpendicular to and centered along the northernmost edge of Component A00006.

Component Ref #: A00006      Component Type: Area - Fill      Color Token: Black  
 Description: Black solid fill  
Parameters:  
 Note: The surface geometry is filled with the solid color.

Component Ref #: P00019      Component Type: Point - Shape      Color Token: Black  
 Description: Building pagoda  
Parameters:  
 Note: See Annex H for detailed drawing instructions.

**Symbol Rules**

Reference #: **PS-04683**      Description: **General Building / non-obstruction / intact / pagoda (area)**      Criteria:  
 Height Above Surface Level [HGT] < 46  
 AND Condition of Facility [FUN] = (Fully Functional [6], Unknown [0])  
 AND Feature Function [FFN] = (Place of Worship [931], Religious Activities [930])  
 AND House of Worship Type [HWT] = Pagoda [11]

**Label Rules**

Label Placement Rules (see Annex J): LP-3505, LP-9999

Reference #:      Description:      Criteria:

PL-04683\_1 General Building / non-obstruction / intact / pagoda (area) N/A

Label String: [Name]  
 Characteristics: 1  
 1 (Black, Condensed, 6 pt, Mixed case)

Symbol Samples



General Building / non-obstruction / intact / stupa (area)



Symbol Graphic

Symbol Placement Instructions: The symbol is applied to the geometry of the feature.

Symbol Type: Complex

Note: The base of Component P00031 is placed perpendicular to and centered along the northernmost edge of Component A00006.

Component Ref #: A00006      Component Type: Area - Fill      Color Token: Black  
 Description: Black solid fill  
 Parameters:  
 Note: The surface geometry is filled with the solid color.

Component Ref #: P00031      Component Type: Point - Shape      Color Token: Black  
 Description: Building stupa  
 Parameters:  
 Note: See Annex H for detailed drawing instructions.

Symbol Rules

Reference #:	Description:	Criteria:
PS-04684	General Building / non-obstruction / intact / stupa (area)	Height Above Surface Level [HGT] < 46
	AND	Condition of Facility [FUN] = (Fully Functional [6], Unknown [0])
	AND	Feature Function [FFN] = (Place of Worship [931], Religious Activities [930])
	AND	House of Worship Type [HWT] = Stupa [21]

Label Rules

Label Placement Rules (see Annex J): LP-3505, LP-9999

Reference #:	Description:	Criteria:
PL-04684_1	General Building / non-obstruction / intact / stupa (area)	N/A

Label String: [Name]  
 Characteristics: 1  
 1 (Black, Condensed, 6 pt, Mixed case)

Symbol Samples



General Building / non-obstruction / intact / judaism (area)



Symbol Graphic

**Symbol Placement Instructions:** The symbol is applied to the geometry of the feature.

**Symbol Type:** Complex

**Note:** The base of Component P00017 is placed perpendicular to and centered along the northernmost edge of Component A00006.

<b>Component Ref #:</b>	A00006	<b>Component Type:</b>	Area - Fill	<b>Color Token:</b>	Black
<b>Description:</b>	Black solid fill				
<b>Parameters:</b>					
<b>Note:</b>	The surface geometry is filled with the solid color.				

<b>Component Ref #:</b>	P00017	<b>Component Type:</b>	Point - Shape	<b>Color Token:</b>	Black
<b>Description:</b>	Building Judaism "T"				
<b>Parameters:</b>					
<b>Note:</b>	See Annex H for detailed drawing instructions.				

**Symbol Rules**

Reference #:	Description:	Criteria:
<b>PS-04685</b>	<b>General Building / non-obstruction / intact / judaism (area)</b>	Height Above Surface Level [HGT] < 46
		AND Condition of Facility [FUN] = (Fully Functional [6], Unknown [0])
		AND Feature Function [FFN] = (Place of Worship [931], Religious Activities [930])
		AND House of Worship Type [HWT] = Synagogue [20]

**Label Rules**

Label Placement Rules (see Annex J): LP-3505, LP-9999

Reference #:	Description:	Criteria:
<b>PL-04685_1</b>	<b>General Building / non-obstruction / intact / judaism (area)</b>	N/A
	<b>Label String:</b> [Name]	
	<b>Characteristics:</b> 1	
	1 (Black, Condensed, 6 pt, Mixed case)	

**Symbol Samples**



**General Building / non-obstruction / intact / temple (area)**



Symbol Graphic

**Symbol Placement Instructions:** The symbol is applied to the geometry of the feature.

**Symbol Type:** Complex

**Note:** The base of Component P00018 is placed perpendicular to and centered along the northernmost edge of Component A00006.

<b>Component Ref #:</b>	A00006	<b>Component Type:</b>	Area - Fill	<b>Color Token:</b>	Black
<b>Description:</b>	Black solid fill				
<b>Parameters:</b>					
<b>Note:</b>	The surface geometry is filled with the solid color.				

<b>Component Ref #:</b>	P00018	<b>Component Type:</b>	Point - Shape	<b>Color Token:</b>	Black
<b>Description:</b>	Building temple				
<b>Parameters:</b>					
<b>Note:</b>	See Annex H for detailed drawing instructions.				

**Symbol Rules**

Reference #:	Description:	Criteria:
--------------	--------------	-----------

**PS-04686 General Building / non-obstruction / intact / temple (area)**

Height Above Surface Level [HGT] < 46

- AND Condition of Facility [FUN] = (Fully Functional [6], Unknown [0])
- AND Feature Function [FFN] = (Place of Worship [931], Religious Activities [930])
- AND House of Worship Type [HWT] = Temple [16]

**Label Rules**

Label Placement Rules (see Annex J): LP-3505, LP-9999

Reference #: Description: Criteria:

**PL-04686\_1** General Building / non-obstruction / intact / temple (area) N/A

Label String: [Name]  
 Characteristics: 1  
 1 (Black, Condensed, 6 pt, Mixed case)

**Symbol Samples**



**General Building / non-obstruction / intact / house of worship (area)**



Symbol Graphic

Symbol Placement Instructions: The symbol is applied to the geometry of the feature.  
 Symbol Type: Simple

Component Ref #: A00006 Component Type: Area - Fill Color Token: Black  
 Description: Black solid fill  
 Parameters:  
 Note: The surface geometry is filled with the solid color.

**Symbol Rules**

Reference #: Description: Criteria:  
**PS-04687** General Building / non-obstruction / intact / house of worship (area) Height Above Surface Level [HGT] < 46  
 AND Condition of Facility [FUN] = (Fully Functional [6], Unknown [0])  
 AND Feature Function [FFN] = (Place of Worship [931], Religious Activities [930])  
 AND House of Worship Type [HWT] = (Not Applicable [998], Other [999], Religious Community [7], Shrine [14], Unknown [0])

**Label Rules**

Label Placement Rules (see Annex J): LP-3505, LP-4813, LP-9999

Reference #: Description: Criteria:

**PL-04687\_1** General Building / non-obstruction / intact / house of worship / known (area) House of Worship Type [HWT] = (Religious Community [7], Shrine [14])

Label String: [Name] [House of Worship Type]  
 Characteristics: 1, 1  
 1 (Black, Condensed, 6 pt, Mixed case)

**PL-04687\_2** General Building / non-obstruction / intact / house of worship / other (area) House of Worship Type [HWT] = (Not Applicable [998], Other [999], Unknown[0])

AND Name [NAM] <> Unknown

Label String: [Name]  
 Characteristics: 1  
 1 (Black, Condensed, 6 pt, Mixed case)



**PL-04687\_3 General Building / non-obstruction / intact / house of worship / unknown (area)**

House of Worship Type [HWT] = (Not Applicable [998], Other [999], Unknown[0])

AND Name [NAM] = Unknown

Label String: "House of worship"  
 Characteristics: 1  
 1 (Black, Condensed, 6 pt, Mixed case)

Symbol Samples

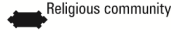
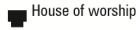

**General Building / non-obstruction / intact / school (area)**



Symbol Graphic

Symbol Placement Instructions: The symbol is applied to the geometry of the feature.

Symbol Type: Complex

Note: The base of Component P00016 is placed perpendicular to and centered along the northernmost edge of Component A00006.

Component Ref #: A00006      Component Type: Area - Fill      Color Token: Black  
 Description: Black solid fill  
[Parameters:](#)  
 Note: The surface geometry is filled with the solid color.

Component Ref #: P00016      Component Type: Point - Shape      Color Token: Black  
 Description: Building school flag  
[Parameters:](#)  
 Note: See Annex H for detailed drawing instructions.

Symbol Rules

Reference #:	Description:	Criteria:
PS-04688	General Building / non-obstruction / intact / school (area)	Height Above Surface Level [HGT] < 46
	AND	Condition of Facility [FUN] = (Fully Functional [6], Unknown [0])
	AND	Feature Function [FFN] = (Education [850], Higher Education [855])

Label Rules

Label Placement Rules (see Annex J): LP-3505, LP-9999

Reference #:	Description:	Criteria:
PL-04688_1	General Building / non-obstruction / intact / school (area)	N/A

Label String: [Name]  
 Characteristics: 1  
 1 (Black, Condensed, 6 pt, Mixed case)

Symbol Samples



**General Building / non-obstruction / intact / hospital (area)**

**Symbol Placement Instructions:** The symbol is applied to the geometry of the feature.

**Symbol Type:** Complex



Symbol Graphic

**Note:** Component P00012 is placed in the center of Component A00006.

<b>Component Ref #:</b>	A00006	<b>Component Type:</b>	Area - Fill	<b>Color Token:</b>	Black
<b>Description:</b>	Black solid fill				
<b>Parameters:</b>					
<b>Note:</b>	The surface geometry is filled with the solid color.				

<b>Component Ref #:</b>	P00296	<b>Component Type:</b>	Point - Shape	<b>Color Token:</b>	Black
<b>Description:</b>	Building hospital symbol				
<b>Parameters:</b>					
<b>Note:</b>	See Annex H for detailed drawing instructions.				

**Symbol Rules**

Reference #:	Description:	Criteria:
<b>PS-04689</b>	<b>General Building / non-obstruction / intact / hospital (area)</b>	Height Above Surface Level [HGT] < 46
	AND	Condition of Facility [FUN] = (Fully Functional [6], Unknown [0])
	AND	Feature Function [FFN] = (Human Health Activities [860], In-patient Care [861])

**Label Rules**

Label Placement Rules (see Annex J): LP-3505, LP-9999

Reference #:	Description:	Criteria:
<b>PL-04689_1</b>	<b>General Building / non-obstruction / intact / hospital (area)</b>	N/A

**Label String:** [Name]  
**Characteristics:** 1  
 1 (Black, Condensed, 6 pt, Mixed case)

**Symbol Samples**



**General Building / non-obstruction / intact / diplomatic (area)**

**Symbol Placement Instructions:** The symbol is applied to the geometry of the feature.

**Symbol Type:** Complex



Symbol Graphic

**Note:** The base of Component P00285 is placed perpendicular to and centered along the northernmost edge of Component A00006.

<b>Component Ref #:</b>	A00006	<b>Component Type:</b>	Area - Fill	<b>Color Token:</b>	Black
<b>Description:</b>	Black solid fill				
<b>Parameters:</b>					
<b>Note:</b>	The surface geometry is filled with the solid color.				

<b>Component Ref #:</b>	P00285	<b>Component Type:</b>	Point - Shape	<b>Color Token:</b>	Black
<b>Description:</b>	Building diplomatic flag				
<b>Parameters:</b>					
<b>Note:</b>	See Annex H for detailed drawing instructions.				

**Symbol Rules**

Reference #:	Description:	Criteria:
<b>PS-04691</b>	<b>General Building / non-obstruction / intact / diplomatic (area)</b>	Height Above Surface Level [HGT] < 46

- AND Condition of Facility [FUN] = (Fully Functional [6], Unknown [0])
- AND Feature Function [FFN] = (Diplomacy [825], Embassy [827])

Label Rules

Label Placement Rules (see Annex J): LP-3505, LP-9999

Reference #:	Description:	Criteria:
PL-04691_1	<b>General Building / non-obstruction / intact / diplomatic (area)</b>	N/A
	Label String: [Name]	
	Characteristics: 1 1 (Black, Condensed, 6 pt, Mixed case)	

Symbol Samples

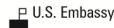

General Building / non-obstruction / intact / petrol sale (area)



Symbol Graphic

Symbol Placement Instructions: The symbol is applied to the geometry of the feature.

Symbol Type: Complex

Note: The base of Component P00275 is placed perpendicular to and centered along the northernmost edge of Component A00006.

Component Ref #:	A00006	Component Type:	Area - Fill	Color Token:	Black
Description:	Black solid fill				
Parameters:					
Note:	The surface geometry is filled with the solid color.				

---

Component Ref #:	P00275	Component Type:	Point - Shape	Color Token:	Black
Description:	Motor vehicle station symbol				
Parameters:					
Note:	See Annex H for detailed drawing instructions.				

Symbol Rules

Reference #:	Description:	Criteria:
PS-04708	<b>General Building / non-obstruction / intact / petrol sale (area)</b>	Height Above Surface Level [HGT] < 46
	AND	Condition of Facility [FUN] = (Fully Functional [6], Unknown [0])
	AND	Feature Function [FFN] = Petrol Sale [470]

Symbol Samples



General Building / non-obstruction / not intact (area)



Symbol Graphic

Symbol Placement Instructions: The symbol is applied to the geometry of the feature.

Symbol Type: Complex

Note: Component L00007 is applied to the perimeter and is filled with Component A00064.

Component Ref #:	A00064	Component Type:	Area - Fill	Color Token:	Black-12
Description:	Black-12 area fill				
Parameters:					
Screen Angle:	45 degrees				
Screen Percent:	12%				

Component Ref #:	L00007	Component Type:	Line - Simple	Color Token:	Black
Description:	Black 0.1mm Solid Line				
Parameters:					
Line Weight:	0.1mm				

Symbol Rules

Reference #:	Description:	Criteria:
PS-04692	General Building / non-obstruction / not intact (area)	Height Above Surface Level [HGT] < 46
	AND	Condition of Facility [FUN] = (Abandoned [2], Damaged [13], Destroyed [3], Dismantled [4], Under Construction [1])

Label Rules

Label Placement Rules (see Annex J): LP-3505, LP-9999

Reference #:	Description:	Criteria:
PL-04692_1	General Building / non-obstruction / not intact (area)	Feature Function [FFN] = (Auditorium [892], Diplomacy [825], Education [850], Embassy [827], Firefighting [845], Government [811], Grain Milling [107], Higher Education [855], Human Health Activities [860], In-patient Care [861], Library [902], Motor Vehicle Manufacture [290], Museum [905], Observation Station [721], Oil-mill [105], Opera House [894], Palace [815], Paper-mill [171], Petroleum Refining [192], Place of Worship [931], Religious Activities [930], Sawmilling [161], Sports Centre [912], Steel Mill [241], Terminal [481], Theatre [891], Weather Station [722], Wind Tunnel [730], Yacht-club [955])
	Label String:	[Name]
	Characteristics:	1 1 (Black, Condensed, 6 pt, Mixed case)

Symbol Samples



General Building / non-obstruction / intact / generic (point)



Symbol Graphic

Symbol Placement Instructions: Origin: Center of symbol

Symbol Type: Simple

Component Ref #:	P00050	Component Type:	Point - Simple	Color Token:	Black
Description:	Black filled square with all sides 0.5mm				
Parameters:					
Length:	0.5mm				
Note:	The component is a square and is filled with the solid color.				

Symbol Rules

Reference #:	Description:	Criteria:
PS-04693	General Building / non-obstruction / intact / generic (point)	Height Above Surface Level [HGT] < 46
	AND	Condition of Facility [FUN] = (Fully Functional [6], Unknown [0])

AND Feature Function [FFN] = (Accommodation [550], Administration [810], Agriculture [2], Aircraft Repair [341], Animal Boarding [919], Commerce [440], Community Centre [893], Cooling [355], General Repair [330], Guard [781], Harbour Control [513], Institution [859], Manufacturing [99], Maritime Pilotage [511], Market [475], Motor Vehicle Parking [535], Motor Vehicle Repair [343], Other [999], Postal Activities [540], Power Generation [351], Print Publishing [582], Pumping [501], Radio Broadcasting [601], Residence [563], Restaurant [572], Retail Banking [643], Satellite Ground Control [626], Scientific Research and Development [720], Signalling [486], Social Work [887], Telecommunications [610], Television Broadcasting [604], Transport [480], Unknown [0], Utilities [350], Warehousing and Storage [530], Water Treatment [362])

Symbol Samples

General Building / non-obstruction / intact / important (point)

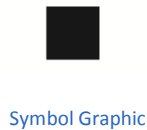

Symbol Placement Instructions: Origin: Center of symbol  
 Symbol Type: Simple

Component Ref #:	P00006	Component Type:	Point - Simple	Color Token:	Black
Description:	Black filled square with all sides 0.8mm				
Parameters:					
Length:	0.8mm				
Note:	The component is a square and is filled with the solid color.				

Symbol Rules

Reference #:	Description:	Criteria:
PS-04694	General Building / non-obstruction / intact / important (point)	Height Above Surface Level [HGT] < 46
	AND	Condition of Facility [FUN] = (Fully Functional [6], Unknown [0])
	AND	Feature Function [FFN] = (Auditorium [892], Defence Activities [835], Firefighting [845], Government [811], Grain Milling [107], Imprisonment [843], Law Enforcement [841], Library [902], Motor Vehicle Manufacture [290], Museum [905], Observation Station [721], Oil-mill [105], Opera House [894], Palace [815], Paper-mill [171], Petroleum Refining [192], Sawmilling [161], Sports Centre [912], Steel Mill [241], Terminal [481], Theatre [891], Weather Station [722], Wind Tunnel [730], Yacht-club [955])

Label Rules

Label Placement Rules (see Annex J): LP-3505, LP-4813, LP-9999

Reference #:	Description:	Criteria:
PL-04694_1	General Building / non-obstruction / intact / important / other (point)	Feature Function [FFN] = (Auditorium [892], Firefighting [845], Government [811], Grain Milling [107], Library [902], Motor Vehicle Manufacture [290], Museum [905], Observation Station [721], Oil-mill [105], Opera House [894], Palace [815], Paper-mill [171], Petroleum Refining [192], Sawmilling [161], Sports Centre [912], Steel Mill [241], Terminal [481], Theatre [891], Weather Station [722], Wind Tunnel [730], Yacht-club [955])
	Label String:	[Name] [Feature Function]
	Characteristics:	1, 1 1 (Black, Condensed, 6 pt, Mixed case)
PL-04694_2	General Building / non-obstruction / intact / important / military (point)	Feature Function [FFN] = Defence Activities [835]
	Label String:	[Name] "Military"
	Characteristics:	1, 1 1 (Black, Condensed, 6 pt, Mixed case)

**PL-04694\_3** **General Building / non-obstruction / intact / important / police (point)**  
 Label String: [Name] "Police"  
 Characteristics: 1, 1  
 1 (Black, Condensed, 6 pt, Mixed case)

Feature Function [FFN] = Law Enforcement [841]

**PL-04694\_4** **General Building / non-obstruction / intact / important / prison (point)**  
 Label String: [Name] "Prison"  
 Characteristics: 1, 1  
 1 (Black, Condensed, 6 pt, Mixed case)

Feature Function [FFN] = Imprisonment [843]

Symbol Samples



Police

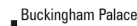

Buckingham Palace

**General Building / non-obstruction / intact / christian (point)**



Symbol Graphic

Symbol Placement Instructions: Origin: Center of filled square

Symbol Type: Simple

Component Ref #: P00075      Component Type: Point - Shape      Color Token: Black  
 Description: Building Christian  
 Parameters:  
 Note: See Annex H for detailed drawing instructions.

Symbol Rules

Reference #:	Description:	Criteria:
<b>PS-04695</b>	<b>General Building / non-obstruction / intact / christian (point)</b>	Height Above Surface Level [HGT] < 46
	AND	Condition of Facility [FUN] = (Fully Functional [6], Unknown [0])
	AND	Feature Function [FFN] = (Place of Worship [931], Religious Activities [930])
	AND	House of Worship Type [HWT] = (Cathedral [2], Chapel [3], Church [4], Tabernacle [15])

Label Rules

Label Placement Rules (see Annex J): LP-3505, LP-9999

Reference #:	Description:	Criteria:
<b>PL-04695_1</b>	<b>General Building / non-obstruction / intact / christian (point)</b>	N/A
	Label String: [Name]	
	Characteristics: 1	
	1 (Black, Condensed, 6 pt, Mixed case)	

Symbol Samples



†



† First Baptist

**General Building / non-obstruction / intact / minaret (point)**



Symbol Graphic

Symbol Placement Instructions: Origin: Center of dot

Symbol Type: Simple

Component Ref #:	P00184	Component Type:	Point - Shape	Color Token:	Black
Description:	Building minaret				
<a href="#">Parameters:</a>					
Note:	See Annex H for detailed drawing instructions.				

### Symbol Rules

Reference #:	Description:	Criteria:
PS-04696	<b>General Building / non-obstruction / intact / minaret (point)</b>	Height Above Surface Level [HGT] < 46
	AND	Condition of Facility [FUN] = (Fully Functional [6], Unknown [0])
	AND	Feature Function [FFN] = (Place of Worship [931], Religious Activities [930])
	AND	House of Worship Type [HWT] = Minaret [6]

### Label Rules

Label Placement Rules (see Annex J): LP-3505, LP-9999

Reference #:	Description:	Criteria:
PL-04696_1	<b>General Building / non-obstruction / intact / minaret (point)</b>	N/A

Label String: [Name]  
 Characteristics: 1  
 1 (Black, Condensed, 6 pt, Mixed case)

### Symbol Samples



## General Building / non-obstruction / intact / islam (point)



Symbol Graphic

Symbol Placement Instructions: Origin: Center of filled square

Symbol Type: Simple

Component Ref #:	P00076	Component Type:	Point - Shape	Color Token:	Black
Description:	Building Islamic				
<a href="#">Parameters:</a>					
Note:	See Annex H for detailed drawing instructions.				

### Symbol Rules

Reference #:	Description:	Criteria:
PS-04697	<b>General Building / non-obstruction / intact / islam (point)</b>	Height Above Surface Level [HGT] < 46
	AND	Condition of Facility [FUN] = (Fully Functional [6], Unknown [0])
	AND	Feature Function [FFN] = (Place of Worship [931], Religious Activities [930])
	AND	House of Worship Type [HWT] = (Marabout [5], Mosque [9])

### Label Rules

Label Placement Rules (see Annex J): LP-3505, LP-9999

Reference #:	Description:	Criteria:

PL-04697\_1 General Building / non-obstruction / intact / islam (point) N/A

Label String: [Name]  
 Characteristics: 1  
 1 (Black, Condensed, 6 pt, Mixed case)

Symbol Samples



General Building / non-obstruction / intact / pagoda (point)



Symbol Graphic

Symbol Placement Instructions: Origin: Center of open square  
 Symbol Type: Simple

Component Ref #: P00019 Component Type: Point - Shape Color Token: Black  
 Description: Building pagoda  
 Parameters:  
 Note: See Annex H for detailed drawing instructions.

Symbol Rules

Reference #:	Description:	Criteria:
PS-04698	General Building / non-obstruction / intact / pagoda (point)	Height Above Surface Level [HGT] < 46
	AND	Condition of Facility [FUN] = (Fully Functional [6], Unknown [0])
	AND	Feature Function [FFN] = (Place of Worship [931], Religious Activities [930])
	AND	House of Worship Type [HWT] = Pagoda [11]

Label Rules

Label Placement Rules (see Annex J): LP-3505, LP-9999

Reference #:	Description:	Criteria:
PL-04698_1	General Building / non-obstruction / intact / pagoda (point)	N/A

Label String: [Name]  
 Characteristics: 1  
 1 (Black, Condensed, 6 pt, Mixed case)

Symbol Samples



General Building / non-obstruction / intact / stupa (point)



Symbol Graphic

Symbol Placement Instructions: Origin: Center of symbol  
 Symbol Type: Simple



Component Ref #: P00031      Component Type: Point - Shape      Color Token: Black  
 Description: Building stupa  
[Parameters:](#)  
 Note: See Annex H for detailed drawing instructions.

**Symbol Rules**

<b>Reference #:</b>	<b>Description:</b>	<b>Criteria:</b>
<b>PS-04699</b>	<b>General Building / non-obstruction / intact / stupa (point)</b>	Height Above Surface Level [HGT] < 46
	AND	Condition of Facility [FUN] = (Fully Functional [6], Unknown [0])
	AND	Feature Function [FFN] = (Place of Worship [931], Religious Activities [930])
	AND	House of Worship Type [HWT] = Stupa [21]

**Label Rules**

Label Placement Rules (see Annex J): LP-3505, LP-9999

<b>Reference #:</b>	<b>Description:</b>	<b>Criteria:</b>
<b>PL-04699_1</b>	<b>General Building / non-obstruction / intact / stupa (point)</b>	N/A

Label String: [Name]  
 Characteristics: 1  
 1 (Black, Condensed, 6 pt, Mixed case)

**Symbol Samples**



**General Building / non-obstruction / intact / judaism (point)**



Symbol Graphic

Symbol Placement Instructions: Origin: Center of filled square  
 Symbol Type: Simple

Component Ref #: P00077      Component Type: Point - Shape      Color Token: Black  
 Description: Building Judaism  
[Parameters:](#)  
 Note: See Annex H for detailed drawing instructions.

**Symbol Rules**

<b>Reference #:</b>	<b>Description:</b>	<b>Criteria:</b>
<b>PS-04700</b>	<b>General Building / non-obstruction / intact / judaism (point)</b>	Height Above Surface Level [HGT] < 46
	AND	Condition of Facility [FUN] = (Fully Functional [6], Unknown [0])
	AND	Feature Function [FFN] = (Place of Worship [931], Religious Activities [930])
	AND	House of Worship Type [HWT] = Synagogue [20]

**Label Rules**

Label Placement Rules (see Annex J): LP-3505, LP-9999

<b>Reference #:</b>	<b>Description:</b>	<b>Criteria:</b>
<b>PL-04700_1</b>	<b>General Building / non-obstruction / intact / judaism (point)</b>	N/A

Label String: [Name]  
 Characteristics: 1  
 1 (Black, Condensed, 6 pt, Mixed case)

**Symbol Samples**

I

Amuna  
I

**General Building / non-obstruction / intact / temple (point)**



Symbol Graphic

Symbol Placement Instructions: Origin: Center of open rectangle

Symbol Type: Simple

Component Ref #: P00018      Component Type: Point - Shape      Color Token: Black  
 Description: Building temple  
 Parameters:  
 Note: See Annex H for detailed drawing instructions.

**Symbol Rules**

Reference #:	Description:	Criteria:
<b>PS-04701</b>	<b>General Building / non-obstruction / intact / temple (point)</b>	Height Above Surface Level [HGT] < 46
	AND	Condition of Facility [FUN] = (Fully Functional [6], Unknown [0])
	AND	Feature Function [FFN] = (Place of Worship [931], Religious Activities [930])
	AND	House of Worship Type [HWT] = Temple [16]

**Label Rules**

Label Placement Rules (see Annex J): LP-3505, LP-9999

Reference #:	Description:	Criteria:
<b>PL-04701_1</b>	<b>General Building / non-obstruction / intact / temple (point)</b>	N/A

Label String: [Name]  
 Characteristics: 1  
 1 (Black, Condensed, 6 pt, Mixed case)

**Symbol Samples**



Wat Buddha Lela

**General Building / non-obstruction / intact / house of worship (point)**



Symbol Graphic

Symbol Placement Instructions: Origin: Center of symbol

Symbol Type: Simple

Component Ref #: P00006      Component Type: Point - Simple      Color Token: Black  
 Description: Black filled square with all sides 0.8mm  
 Parameters:  
 Length: 0.8mm  
 Note: The component is a square and is filled with the solid color.

Symbol Rules

<b>Reference #:</b>	<b>Description:</b>	<b>Criteria:</b>
<b>PS-04704</b>	<b>General Building / non-obstruction / intact / house of worship (point)</b>	Height Above Surface Level [HGT] < 46
	AND	Condition of Facility [FUN] = (Fully Functional [6], Unknown [0])
	AND	Feature Function [FFN] = (Place of Worship [931], Religious Activities [930])
	AND	House of Worship Type [HWT] = (Not Applicable [998], Other [999], Religious Community [7], Shrine [14], Unknown [0])

Label Rules

Label Placement Rules (see Annex J): LP-3505, LP-4813, LP-9999

<b>Reference #:</b>	<b>Description:</b>	<b>Criteria:</b>
<b>PL-04704_1</b>	<b>General Building / non-obstruction / intact / house of worship / known(point)</b>	House of Worship Type [HWT] = (Religious Community [7], Shrine [14])
	<b>Label String:</b> [Name] [House of Worship Type]	
	<b>Characteristics:</b> 1, 1 1 (Black, Condensed, 6 pt, Mixed case)	
<b>PL-04704_2</b>	<b>General Building / non-obstruction / intact / house of worship / other (point)</b>	House of Worship Type [HWT] = (Not Applicable [998], Other [999], Unknown[0])
	AND	Name [NAM] <> Unknown
	<b>Label String:</b> [Name]	
	<b>Characteristics:</b> 1 1 (Black, Condensed, 6 pt, Mixed case) 22 (Black, Condensed, 6 pt, Lower case)	
<b>PL-04704_3</b>	<b>General Building / non-obstruction / intact / house of worship / unknown (point)</b>	House of Worship Type [HWT] = (Not Applicable [998], Other [999], Unknown[0])
	AND	Name [NAM] = Unknown
	<b>Label String:</b> "House of worship"	
	<b>Characteristics:</b> 1 1 (Black, Condensed, 6 pt, Mixed case)	

Symbol Samples

■ House of worship

■ Shrine

General Building / non-obstruction / intact / school (point)



Symbol Graphic

Symbol Placement Instructions: Origin: Center of filled square

Symbol Type: Simple

<b>Component Ref #:</b>	P00118	<b>Component Type:</b>	Point - Shape	<b>Color Token:</b>	Black
<b>Description:</b>	Building school				
<b>Parameters:</b>					
<b>Note:</b>	See Annex H for detailed drawing instructions.				

Symbol Rules

<b>Reference #:</b>	<b>Description:</b>	<b>Criteria:</b>
<b>PS-04706</b>	<b>General Building / non-obstruction / intact / school (point)</b>	Height Above Surface Level [HGT] < 46
	AND	Condition of Facility [FUN] = (Fully Functional [6], Unknown [0])
	AND	Feature Function [FFN] = (Education [850], Higher Education [855])

Label Rules

Label Placement Rules (see Annex J): LP-3505, LP-9999

Reference #: Description: Criteria:  
**PL-04706\_1** **General Building / non-obstruction / intact / school (point)** N/A

Label String: [Name]  
 Characteristics: 1  
 1 (Black, Condensed, 6 pt, Mixed case)

Symbol Samples



General Building / non-obstruction / intact / hospital (point)



Symbol Graphic

Symbol Placement Instructions: Origin: Center of symbol  
 Symbol Type: Simple

Component Ref #: P00012 Component Type: Point - Shape Color Token: Black  
 Description: Building hospital  
[Parameters:](#)  
 Note: See Annex H for detailed drawing instructions.

Symbol Rules

Reference #: Description: Criteria:  
**PS-04707** **General Building / non-obstruction / intact / hospital (point)** Height Above Surface Level [HGT] < 46  
 AND Condition of Facility [FUN] = (Fully Functional [6], Unknown [0])  
 AND Feature Function [FFN] = (Human Health Activities [860], In-patient Care [861])

Label Rules

Label Placement Rules (see Annex J): LP-3505, LP-9999

Reference #: Description: Criteria:  
**PL-04707\_1** **General Building / non-obstruction / intact / hospital (point)** N/A

Label String: [Name]  
 Characteristics: 1  
 1 (Black, Condensed, 6 pt, Mixed case)

Symbol Samples



General Building / non-obstruction / intact / diplomatic (point)



Symbol Graphic

Symbol Placement Instructions: Origin: Center of filled square

Symbol Type: Simple

Component Ref #:	P00186	Component Type:	Point - Shape	Color Token:	Black
Description:	Building diplomatic				
<a href="#">Parameters:</a>					
Note:	See Annex H for detailed drawing instructions.				

### Symbol Rules

Reference #:	Description:	Criteria:
PS-04476	General Building / non-obstruction / intact / diplomatic (point)	Height Above Surface Level [HGT] < 46
	AND	Condition of Facility [FUN] = (Fully Functional [6], Unknown [0])
	AND	Feature Function [FFN] = (Diplomacy [825], Embassy [827])

### Label Rules

Label Placement Rules (see Annex J): LP-3505, LP-9999

Reference #:	Description:	Criteria:
PL-04476_1	General Building / non-obstruction / intact / diplomatic (point)	N/A
	Label String: [Name]	
	Characteristics: 1	
	1 (Black, Condensed, 6 pt, Mixed case)	

### Symbol Samples



U. S. Embassy

## General Building / non-obstruction / intact / petrol sale (point)



Symbol Graphic

Symbol Placement Instructions: Origin: Center of filled square

Symbol Type: Simple

Component Ref #:	P00165	Component Type:	Point - Shape	Color Token:	Black
Description:	Motor vehicle station				
<a href="#">Parameters:</a>					
Note:	See Annex H for detailed drawing instructions.				

### Symbol Rules

Reference #:	Description:	Criteria:
PS-04709	General Building / non-obstruction / intact / petrol sale (point)	Height Above Surface Level [HGT] < 46
	AND	Condition of Facility [FUN] = (Fully Functional [6], Unknown [0])
	AND	Feature Function [FFN] = Petrol Sale [470]

### Symbol Samples

Y

**General Building / non-obstruction / not intact (point)**



Symbol Graphic

Symbol Placement Instructions: Origin: Center of symbol

Symbol Type: Simple

Component Ref #: P00293      Component Type: Point - Shape      Color Token: Black/Black-12  
 Description: Not intact square 0.6mm  
 Parameters:  
 Note: See Annex H for detailed drawing instructions.

**Symbol Rules**

Reference #:	Description:	Criteria:
PS-04714	<b>General Building / non-obstruction / not intact (point)</b>	Height Above Surface Level [HGT] < 46
	AND	Condition of Facility [FUN] = (Abandoned [2], Damaged [13], Destroyed [3], Dismantled [4], Under Construction [1])

**Symbol Samples**

•

**Geologic Fault (DB110)**

Generalization Rules (see Annex J): GA-9999

**Geologic Fault / all (line)**



Symbol Graphic

Symbol Placement Instructions: The symbol is applied to the geometry of the feature.

Symbol Type: Simple

Component Ref #: L00023      Component Type: Line - Simple      Color Token: Dk-Brown1815  
 Description: Dk-Brown1815 0.2mm Solid Line  
 Parameters:  
 Line Weight: 0.2mm

**Symbol Rules**

Reference #:	Description:	Criteria:
PS-04252	<b>Geologic Fault / all (line)</b>	All

**Label Rules**

Label Placement Rules (see Annex J): LP-3630, LP-4813, LP-9999

Reference #:	Description:	Criteria:
PL-04252_1	<b>Geologic Fault / all (line)</b>	N/A

Label String: [Name] "Fault"

Characteristics: 5, 5  
5 (Black, Condensed, Italic, 6 pt, Mixed case)

Symbol Samples

*Fault*

*San Andreas Fault*

## Geophysical Prospecting Grid (FA090)

Generalization Rules (see Annex J): GA-9999

### Geophysical Prospecting Grid / all (line)

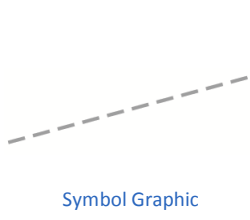

Symbol Placement Instructions: The symbol is applied to the geometry of the feature.

Symbol Type: Simple

Component Ref #:	L00452	Component Type:	Line - Styled	Color Token:	Black-54
Description:	Black-54 0.2mm Screened Dashed Line (0.2mm wt, 1.0mm dash, 0.5mm gap)				
Parameters:					
Line Weight:	0.2mm	Dash Length:	1.0mm	Dash Spacing:	0.5mm
Screen Angle:	45 degrees				
Screen Percent:	54%				

### Symbol Rules

Reference #:	Description:	Criteria:
PS-04899	Geophysical Prospecting Grid / all (line)	All

Symbol Samples

-----

## Geopolitical Entity (FA002)

Generalization Rules (see Annex J): GA-9999

### Geopolitical Entity / other (area)

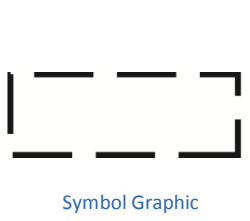

Symbol Placement Instructions: The symbol is applied to the geometry of the feature.

Symbol Type: Simple

Component Ref #:	L00237	Component Type:	Line - Styled	Color Token:	Black
Description:	Black 0.25mm Dashed Line (0.25mm wt, 5.0mm dash, 1.0mm gap)				
Parameters:					
Line Weight:	0.25mm	Dash Length:	5.0mm	Dash Spacing:	1.0mm

### Symbol Rules

Reference #:	Description:	Criteria:

**PS-04537 Geopolitical Entity / other (area)**

Geopolitical Entity Type [GEC] = (Area of No Sovereignty [5], Demilitarized Zone (DMZ) [7], Dependent Political Entity [11], Economic Region [15], Freely Associated State [12], Independent Political Entity [13], Leased Area [9], Other [999], Political Entity [10], Semi-independent Political Entity [14], Territory [16], Unknown [0], Zone of Occupation [8])

**Label Rules**

Label Placement Rules (see Annex J): LP-3506, LP-4813, LP-9999

Reference #: Description:

Criteria:

**PL-04537\_1 Geopolitical Entity / demilitarized zone (DMZ) (area)**

Geopolitical Entity Type [GEC] = Demilitarized Zone (DMZ) [7]

Label String: "DEMILITARIZED ZONE"

Characteristics: 48  
48 (Black, Condensed, Bold, 10 pt, Upper case)

**PL-04537\_2 Geopolitical Entity / zone of occupation (area)**

Geopolitical Entity Type [GEC] = Zone of Occupation [8]

Label String: [Name] "OCCUPIED"

Characteristics: 48, 48  
48 (Black, Condensed, Bold, 10 pt, Upper case)

**PL-04537\_3 Geopolitical Entity / other (area)**

Geopolitical Entity Type [GEC] = (Area of No Sovereignty [5], Buffer Zone [17], Dependent Political Entity [11], Economic Region [15], Freely Associated State [12], Independent Political Entity [13], Leased Area [9], Other [999], Political Entity [10], Semi-independent Political Entity [14], Territory [16], Unknown [0])

Label String: [Name]

Characteristics: 48  
48 (Black, Condensed, Bold, 10 pt, Upper case)

**Symbol Samples**

**DEMILITARIZED ZONE**

**SOUTH OSSETIA OCCUPIED**

**Geopolitical Entity / buffer zone (area)**



Symbol Graphic

Symbol Placement Instructions: The symbol is applied to the geometry of the feature.

Symbol Type: Complex

Repeating Point and Interval: Component P00044 is centered on the first dash of Component L00398, then every fourth dash after that.

Note: Component L00398 is applied to the perimeter and Components L00123 and P00044 are placed on the inside of the surface. Component P00044 is attached on the inside of surface and perpendicular to Component L00398.

Component Ref #:	L00398	Component Type:	Line - Styled	Color Token:	Black
Description:	Black 0.4mm Dashed Line (0.4mm wt, 3.0mm dash, 1.0mm gap)				
Parameters:					
Line Weight:	0.4mm	Dash Length:	3.0mm	Dash Spacing:	1.0mm
Component Ref #:	L00123	Component Type:	Line - Simple	Color Token:	Dk-Brown1815-54
Description:	Dk-Brown1815-54 2.0mm Screened Line				
Parameters:					
Line Weight:	2.0mm	Screen Angle:	60 degrees	Screen Percent:	54%
Component Ref #:	P00044	Component Type:	Point - Simple	Color Token:	Black
Description:	Black 1.5mm length line with a 0.15mm linewidth				
Parameters:					
Line Weight:	0.15mm	Length:	1.5mm		

**Symbol Rules**

Reference #: Description:

Criteria:



**PS-04876 Geopolitical Entity / buffer zone (area)**

Geopolitical Entity Type [GEC] = Buffer Zone [17]

**Label Rules**

Label Placement Rules (see Annex J): LP-3506, LP-9999

Reference #:	Description:	Criteria:
<b>PL-04876_1</b>	<b>Geopolitical Entity / buffer zone (area)</b>	N/A

Label String: [Name]  
 Characteristics: 48  
 48 (Black, Condensed, Bold, 10 pt, Upper case)

**Symbol Samples**

**GIBRALTAR-SPAIN NEUTRAL ZONE**

**Geothermal Outlet (DB115)**

Generalization Rules (see Annex J): GA-9999

**Geothermal Outlet / all (area)**



Symbol Graphic

Symbol Placement Instructions: The symbol is applied to the geometry of the feature.  
 Symbol Type: Simple

Component Ref #:	L00105	Component Type:	Line - Simple	Color Token:	Dk-Brown1815
Description:	Dk-Brown1815 0.3mm Solid Line				
<u>Parameters:</u>					
Line Weight:	0.3mm				

**Symbol Rules**

Reference #:	Description:	Criteria:
<b>PS-04253</b>	<b>Geothermal Outlet / all (area)</b>	All

**Label Rules**

Label Placement Rules (see Annex J): LP-3505, LP-4813, LP-9999

Reference #:	Description:	Criteria:
<b>PL-04253_1</b>	<b>Geothermal Outlet / all (area)</b>	N/A

Label String: [Name] "Geothermal outlet"  
 Characteristics: 1, 1  
 1 (Black, Condensed, 6 pt, Mixed case)

**Symbol Samples**



**Geothermal Outlet / all (point)**



Symbol Graphic

Symbol Placement Instructions: Origin: Center of solid circle

Symbol Type: Simple

Note: Tail of symbol is oriented downstream.

Component Ref #:	P00027	Component Type:	Point - Shape	Color Token:	Dk-Brown1815
Description:	Geothermal outlet				
<a href="#">Parameters:</a>					
Note:	See Annex H for detailed drawing instructions.				

### Symbol Rules

Reference #:	Description:	Criteria:
PS-04254	Geothermal Outlet / all (point)	All

### Label Rules

Label Placement Rules (see Annex J): LP-3505, LP-4813, LP-9999

Reference #:	Description:	Criteria:
PL-04254_1	Geothermal Outlet / all (point)	N/A

Label String: [Name] "Geothermal outlet"  
 Characteristics: 1, 1  
 1 (Black, Condensed, 6 pt, Mixed case)

### Symbol Samples



Geothermal outlet

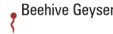

Beehive Geyser

## Glacier (BJ030)

Generalization Rules (see Annex J): GA-9999

### Glacier / all (area)



Symbol Graphic

Symbol Placement Instructions: The symbol is applied to the geometry of the feature.

Symbol Type: Complex

Note: Component L00041 is applied to the perimeter and is filled with Component A00017.

Component Ref #:	A00017	Component Type:	Area - Pattern	Color Token:	Cyan
Description:	Cyan Glacier Fill				
<a href="#">Parameters:</a>					
Area Pattern:	AP-104, see Annex I				

Component Ref #:	L00041	Component Type:	Line - Styled	Color Token:	Cyan
Description:	Cyan 0.2mm Dashed Line (0.2mm wt, 2.0mm dash, 0.5mm gap)				
<a href="#">Parameters:</a>					
Line Weight:	0.2mm	Dash Length:	2.0mm	Dash Spacing:	0.5mm

### Symbol Rules

Reference #:	Description:	Criteria:
PS-04228	Glacier / all (area)	All

### Label Rules

Label Placement Rules (see Annex J): LP-0050, LP-3506, LP-9999

Reference #:	Description:	Criteria:
PL-04228_1	Glacier / all (area)	N/A

Label String: [Name]  
 Characteristics: 38  
 38 (Cyan, Condensed, Italic, 6-16 pt, Mixed case)

Symbol Samples



**Golf Course (AK100)**

Generalization Rules (see Annex J): GA-9999

**Golf Course / all (area)**



Symbol Graphic

Symbol Placement Instructions: The symbol is applied to the geometry of the feature.

Symbol Type: Complex

Note: Component L00368 is applied to the perimeter and is filled with Component A00101.

Component Ref #:	A00101	Component Type:	Area - Fill	Color Token:	Green362-12
Description:	Green362-12 area fill				
Parameters:					
Screen Angle:	45 degrees				
Screen Percent:	12%				

Component Ref #:	L00368	Component Type:	Line - Styled	Color Token:	Green362
Description:	Green362 0.15mm Dashed Line (0.15mm wt, 1.0mm dash, 0.5mm gap)				
Parameters:					
Line Weight:	0.15mm	Dash Length:	1.0mm	Dash Spacing:	0.5mm

Symbol Rules

Reference #:	Description:	Criteria:
PS-04058	Golf Course / all (area)	All

Label Rules

Label Placement Rules (see Annex J): LP-3506, LP-4813, LP-9999

Reference #:	Description:	Criteria:
PL-04058_1	Golf Course / all (area)	N/A

Label String: [Name] "Golf course"  
 Characteristics: 1, 1  
 1 (Black, Condensed, 6 pt, Mixed case)

Symbol Samples



**Grain Elevator (AM030)**

Generalization Rules (see Annex J): GA-9999, GC-9983, GC-9993, GC-9994

**Grain Elevator / non-obstruction / intact (area)**



Symbol Graphic

Symbol Placement Instructions: The symbol is applied to the geometry of the feature.

Symbol Type: Simple

Component Ref #: A00006      Component Type: Area - Fill      Color Token: Black  
 Description: Black solid fill  
[Parameters:](#)  
 Note: The surface geometry is filled with the solid color.

Symbol Rules

Reference #: Description: Criteria:  
**PS-04106** Grain Elevator / non-obstruction / intact (area) Height Above Surface Level [HGT] < 46  
 AND Condition of Facility [FUN] = (Fully Functional [6], Unknown [0])

Label Rules

Label Placement Rules (see Annex J): LP-3505

Reference #: Description: Criteria:  
**PL-04106\_1** Grain Elevator / non-obstruction / intact (area) N/A

Label String: "Grain elevator"  
 Characteristics: 1  
 1 (Black, Condensed, 6 pt, Mixed case)

Symbol Samples

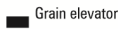

Grain Elevator / non-obstruction / not intact (area)



Symbol Graphic

Symbol Placement Instructions: The symbol is applied to the geometry of the feature.

Symbol Type: Complex

Note: Component L00007 is applied to the perimeter and is filled with Component A00064.

Component Ref #: A00064      Component Type: Area - Fill      Color Token: Black-12  
 Description: Black-12 area fill  
[Parameters:](#)  
 Screen Angle: 45 degrees  
 Screen Percent: 12%

Component Ref #: L00007      Component Type: Line - Simple      Color Token: Black  
 Description: Black 0.1mm Solid Line  
[Parameters:](#)  
 Line Weight: 0.1mm

Symbol Rules

Reference #: Description: Criteria:  
**PS-04781** Grain Elevator / non-obstruction / not intact (area) Height Above Surface Level [HGT] < 46  
 AND Condition of Facility [FUN] = (Abandoned [2], Damaged [13], Destroyed [3], Dismantled [4], Under Construction [1])

Label Rules

Label Placement Rules (see Annex J): LP-3505

Reference #: Description: Criteria:  
**PL-04781\_1** **Grain Elevator / non-obstruction / not intact (area)** N/A

Label String: "Grain elevator"  
 Characteristics: 1  
 1 (Black, Condensed, 6 pt, Mixed case)

Symbol Samples

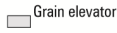

**Grain Elevator / non-obstruction (point)**



Symbol Graphic

Symbol Placement Instructions: Origin: Center of symbol  
 Symbol Type: Simple

Component Ref #: P00010 Component Type: Point - Shape Color Token: Black  
 Description: Located object  
 Parameters:  
 Note: See Annex H for detailed drawing instructions.

Symbol Rules

Reference #: Description: Criteria:  
**PS-04105** **Grain Elevator / non-obstruction (point)** Height Above Surface Level [HGT] < 46

Label Rules

Label Placement Rules (see Annex J): LP-3505

Reference #: Description: Criteria:  
**PL-04105\_1** **Grain Elevator / non-obstruction (point)** N/A

Label String: "Grain elevator"  
 Characteristics: 1  
 1 (Black, Condensed, 6 pt, Mixed case)

Symbol Samples

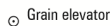

**Grain Storage Structure (AM020)**

Generalization Rules (see Annex J): GA-9999, GC-9983, GC-9993, GC-9994

**Grain Storage Structure / non-obstruction / intact (area)**



Symbol Graphic

Symbol Placement Instructions: The symbol is applied to the geometry of the feature.  
 Symbol Type: Simple

Component Ref #: A00006      Component Type: Area - Fill      Color Token: Black  
 Description: Black solid fill  
Parameters:  
 Note: The surface geometry is filled with the solid color.

**Symbol Rules**

Reference #: Description: Criteria:  
**PS-04101** Grain Storage Structure / non-obstruction / intact (area) Height Above Surface Level [HGT] < 46  
 AND Condition of Facility [FUN] = (Fully Functional [6], Unknown [0])

**Label Rules**

Label Placement Rules (see Annex J): LP-3505

Reference #: Description: Criteria:  
**PL-04101\_1** Grain Storage Structure / non-obstruction / intact (area) N/A

Label String: "Silo"  
 Characteristics: 1  
 1 (Black, Condensed, 6 pt, Mixed case)

**Symbol Samples**



Silo

**Grain Storage Structure / non-obstruction / not intact (area)**



Symbol Graphic

Symbol Placement Instructions: The symbol is applied to the geometry of the feature.  
 Symbol Type: Complex

Note: Component L00007 is applied to the perimeter and is filled with Component A00064.

Component Ref #: A00064      Component Type: Area - Fill      Color Token: Black-12  
 Description: Black-12 area fill  
Parameters:  
 Screen Angle: 45 degrees  
 Screen Percent: 12%

Component Ref #: L00007      Component Type: Line - Simple      Color Token: Black  
 Description: Black 0.1mm Solid Line  
Parameters:  
 Line Weight: 0.1mm

**Symbol Rules**

Reference #: Description: Criteria:  
**PS-04784** Grain Storage Structure / non-obstruction / not intact (area) Height Above Surface Level [HGT] < 46  
 AND Condition of Facility [FUN] = (Abandoned [2], Damaged [13], Destroyed [3], Dismantled [4], Under Construction [1])

**Label Rules**

Label Placement Rules (see Annex J): LP-3505

Reference #: Description: Criteria:  
**PL-04784\_1** Grain Storage Structure / non-obstruction / not intact (area) N/A

Label String: "Silo"  
 Characteristics: 1  
 1 (Black, Condensed, 6 pt, Mixed case)

**Symbol Samples**



## Grain Storage Structure / non-obstruction (point)



Symbol Graphic

Symbol Placement Instructions: Origin: Center of symbol

Symbol Type: Simple

Component Ref #: P00010      Component Type: Point - Shape      Color Token: Black  
 Description: Located object  
Parameters:  
 Note: See Annex H for detailed drawing instructions.

### Symbol Rules

Reference #:	Description:	Criteria:
<b>PS-04102</b>	<b>Grain Storage Structure / non-obstruction (point)</b>	Height Above Surface Level [HGT] < 46

### Label Rules

Label Placement Rules (see Annex J): LP-3505

Reference #:	Description:	Criteria:
<b>PL-04102_1</b>	<b>Grain Storage Structure / non-obstruction (point)</b>	N/A

Label String: "Silo"  
 Characteristics: 1  
 1 (Black, Condensed, 6 pt, Mixed case)

### Symbol Samples



## Grassland (EB010)

Generalization Rules (see Annex J): GA-9999

## Grassland / all (area)



Symbol Graphic

Symbol Placement Instructions: The symbol is applied to the geometry of the feature.

Symbol Type: Simple

Component Ref #: A00126      Component Type: Area - Pattern      Color Token: Green362  
 Description: Green362 Grassland Fill  
Parameters:  
 Area Pattern: No existing MIL\_STD\_2410 area pattern. See Annex I for detailed drawing instructions.

### Symbol Rules

Reference #:	Description:	Criteria:
<b>PS-04030</b>	<b>Grassland / all (area)</b>	All

Symbol Samples



**Greenhouse (AJ110)**

Generalization Rules (see Annex J): GA-9999, GC-9994, GC-9996

**Greenhouse / all (area)**

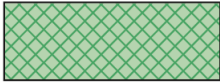

Symbol Graphic

Symbol Placement Instructions: The symbol is applied to the geometry of the feature.

Symbol Type: Complex

Note: Component L00007 is applied to the perimeter and is filled with Components A00059 and A00124. Display level from bottom to top: Component A00059; Component A00124.

Component Ref #:	A00059	Component Type:	Area - Fill	Color Token:	Green362-42
Description:	Green362-42 area fill				
Parameters:					
Screen Angle:	45 degrees				
Screen Percent:	42%				
Component Ref #:	A00124	Component Type:	Area - Pattern	Color Token:	Green362
Description:	Green362 Greenhouse Fill				
Parameters:					
Area Pattern:	LP-6, see Annex I				
Component Ref #:	L00007	Component Type:	Line - Simple	Color Token:	Black
Description:	Black 0.1mm Solid Line				
Parameters:					
Line Weight:	0.1mm				

Symbol Rules

Reference #:	Description:	Criteria:
PS-04396	Greenhouse / all (area)	All

Symbol Samples



**Greenhouse / all (point)**



Symbol Graphic

Symbol Placement Instructions: Origin: Center of symbol

Symbol Type: Simple

Component Ref #:	P00171	Component Type:	Point - Shape	Color Token:	Black/Green362-42
Description:	Greenhouse				
Parameters:					
Note:	See Annex H for detailed drawing instructions.				



Symbol Rules

Reference #: Description: Criteria:  
**PS-04397** **Greenhouse / all (point)** All

Symbol Samples

**Groin (BB043)**

Generalization Rules (see Annex J): GA-9999

**Groin / dry (area)**



Symbol Graphic

Symbol Placement Instructions: The symbol is applied to the geometry of the feature.

Symbol Type: Simple

Note: This symbol is portrayed in conjunction with the Tidal Water symbol and shall mask out the Tidal Water symbol.

Component Ref #: L00007      Component Type: Line - Simple      Color Token: Black  
 Description: Black 0.1mm Solid Line  
Parameters:  
 Line Weight: 0.1mm

Symbol Rules

Reference #: Description: Criteria:  
**PS-04760** **Groin / dry (area)** Water Level Effect [WLE] = (Always Dry [2], Floating [8], Not Applicable [998], Other [999], Unknown [0])

Label Rules

Label Placement Rules (see Annex J): LP-3505

Reference #: Description: Criteria:  
**PL-04760\_1** **Groin / dry (area)** N/A

Label String: "Groin"  
 Characteristics: 1  
 1 (Black, Condensed, 6 pt, Mixed case)

Symbol Samples

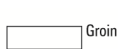

**Groin / not dry (area)**



Symbol Graphic

Symbol Placement Instructions: The symbol is applied to the geometry of the feature.

Symbol Type: Complex

Note: The symbol is shown in conjunction with with Tidal Water symbol and shall not mask out the Tidal Water symbol.

Component Ref #: A00048      Component Type: Area - Fill      Color Token: Black-12  
 Description: Black-12 area fill  
[Parameters:](#)  
 Screen Angle: 15 degrees  
 Screen Percent: 12%

Component Ref #: L00210      Component Type: Line - Styled      Color Token: Black  
 Description: Black 0.1mm Dashed line (0.1mm wt, 1.0mm dash, 0.5mm gap)  
[Parameters:](#)  
 Line Weight: 0.1mm      Dash Length: 1.0mm      Dash Spacing: 0.5mm

**Symbol Rules**

Reference #: Description: Criteria:  
**PS-04761**    **Groin / not dry (area)**      Water Level Effect [WLE] = (Always Submerged [3], Covers and Uncovers [4], Partly Submerged [1])

**Label Rules**

Label Placement Rules (see Annex J): LP-3505

Reference #: Description: Criteria:  
**PL-04761\_1**    **Groin / not dry (area)**      N/A

Label String: "Groin"  
 Characteristics: 1  
 1 (Black, Condensed, 6 pt, Mixed case)

**Symbol Samples**

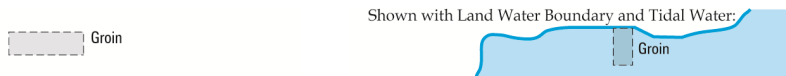

**Groin / dry (line)**

Symbol Placement Instructions: The symbol is applied to the geometry of the feature.  
 Symbol Type: Simple

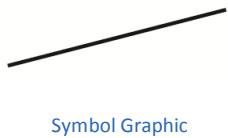

Component Ref #: L00009      Component Type: Line - Simple      Color Token: Black  
 Description: Black 0.2mm Solid Line  
[Parameters:](#)  
 Line Weight: 0.2mm

**Symbol Rules**

Reference #: Description: Criteria:  
**PS-04762**    **Groin / dry (line)**      Water Level Effect [WLE] = (Always Dry [2], Floating [8], Not Applicable [998], Other [999], Unknown [0])

**Label Rules**

Label Placement Rules (see Annex J): LP-3505

Reference #: Description: Criteria:  
**PL-04762\_1**    **Groin / dry (line)**      N/A

Label String: "Groin"  
 Characteristics: 1  
 1 (Black, Condensed, 6 pt, Mixed case)

**Symbol Samples**

Groin

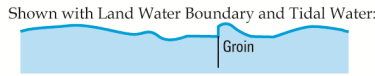

### Groin / not dry (line)

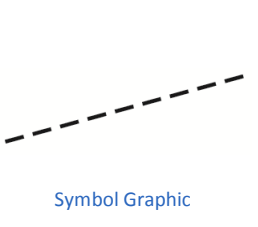

Symbol Placement Instructions: The symbol is applied to the geometry of the feature.

Symbol Type: Simple

Component Ref #:	L00031	Component Type:	Line - Styled	Color Token:	Black
Description:	Black 0.2mm Dashed Line (0.2mm wt, 1.0mm dash, 0.5mm gap)				
Parameters:					
Line Weight:	0.2mm	Dash Length:	1.0mm	Dash Spacing:	0.5mm

#### Symbol Rules

Reference #:	Description:	Criteria:
PS-04763	Groin / not dry (line)	Water Level Effect [WLE] = (Always Submerged [3], Covers and Uncovers [4], Partly Submerged [1])

#### Label Rules

Label Placement Rules (see Annex J): LP-3505

Reference #:	Description:	Criteria:
PL-04763_1	Groin / not dry (line)	N/A

Label String: "Groin"  
 Characteristics: 1  
 1 (Black, Condensed, 6 pt, Mixed case)

#### Symbol Samples

Groin

### Gully (DB200)

Generalization Rules (see Annex J): GA-9999

#### Gully / all (area)

[NAM]

Symbol Graphic

Symbol Placement Instructions: Text label only. No graphic parameters

Symbol Type: Simple

#### Symbol Rules

Reference #:	Description:	Criteria:
PS-04566	Gully / all (area)	All

#### Label Rules

Label Placement Rules (see Annex J): LP-3506, LP-9999

Reference #:	Description:	Criteria:
PL-04566_1	Gully / all (area)	N/A

Label String: [Name]  
 Characteristics: 5  
 5 (Black, Condensed, Italic, 6 pt, Mixed case)

Symbol Samples

*Coley Gully*

**Gully / all (line)**

Symbol Placement Instructions: Text label only. No graphic parameters

Symbol Type: Simple

*[NAM]*

Symbol Graphic

Symbol Rules

Reference #:	Description:	Criteria:
PS-04567	Gully / all (line)	All

Label Rules

Label Placement Rules (see Annex J): LP-3630, LP-9999

Reference #:	Description:	Criteria:
PL-04567_1	Gully / all (line)	N/A

Label String: [Name]  
 Characteristics: 5  
 5 (Black, Condensed, Italic, 6 pt, Mixed case)

Symbol Samples

*Water Mill Gully*

**Harbour (BB005)**

Generalization Rules (see Annex J): GA-9999

**Harbour / all (area)**

Symbol Placement Instructions: Text label only. No graphic parameters

Symbol Type: Simple

*[NAM]*

Symbol Graphic

Symbol Rules

Reference #:	Description:	Criteria:
PS-04602	Harbour / all (area)	All

Label Rules

Label Placement Rules (see Annex J): LP-0050, LP-3506, LP-9999

Reference #:	Description:	Criteria:
PL-04602_1	Harbour / all (area)	N/A

Label String: [Name]  
 Characteristics: 8  
 8 (Black, Condensed, Italic, 6-16 pt, Mixed case)

Symbol Samples

Pearl Harbor

**Hazardous Rock (BD130)**

**Hazardous Rock / exposed (point)**



Symbol Graphic

Symbol Placement Instructions: Origin: Center of symbol

Symbol Type: Simple

Note: No symbol is portrayed if the Water Level Effect (WLE) = Always Submerged [3].

Component Ref #:	P00095	Component Type:	Point - Shape	Color Token:	Black
Description:	Hazardous rock/reef				
Parameters:					
Note:	See Annex H for detailed drawing instructions.				

Symbol Rules

Reference #:	Description:	Criteria:
PS-04658	Hazardous Rock / exposed (point)	Water Level Effect [WLE] = (Always Dry [2], Covers and Uncovers [4], Floating [8], Not Applicable [998], Other [999], Partly Submerged [1], Unknown [0])

Symbol Samples

\*

**Heating Facility (AD050)**

Generalization Rules (see Annex J): GA-9999

**Heating Facility / all (area)**



Symbol Graphic

Symbol Placement Instructions: The symbol is applied to the geometry of the feature.

Symbol Type: Simple

Component Ref #:	L00210	Component Type:	Line - Styled	Color Token:	Black
Description:	Black 0.1mm Dashed line (0.1mm wt, 1.0mm dash, 0.5mm gap)				
Parameters:					
Line Weight:	0.1mm	Dash Length:	1.0mm	Dash Spacing:	0.5mm

Symbol Rules

Reference #:	Description:	Criteria:
PS-04299	Heating Facility / all (area)	All

Label Rules

Label Placement Rules (see Annex J): LP-3506, LP-4813, LP-9950, LP-9999

<p>Reference #: <b>PL-04299_1</b></p> <p>Description: <b>Heating Facility / intact (area)</b></p> <p>Label String: [Name] "Heating facility"</p> <p>Characteristics: 1, 1 1 (Black, Condensed, 6 pt, Mixed case)</p>	<p>Criteria:</p> <p>Condition of Facility [FUN] = (Fully Functional [6], Unknown [0])</p>
--	---

<p>Reference #: <b>PL-04299_2</b></p> <p>Description: <b>Heating Facility / not intact (area)</b></p> <p>Label String: [Name] "Heating facility" "["[Condition of Facility]""]"</p> <p>Characteristics: 1, 1, 22, 22, 22 1 (Black, Condensed, 6 pt, Mixed case) 22 (Black, Condensed, 6 pt, Lower case)</p>	<p>Criteria:</p> <p>Condition of Facility [FUN] = (Abandoned [2], Damaged [13], Destroyed [3], Dismantled [4], Under Construction [1])</p>
---	--

Symbol Samples

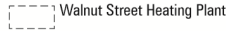

**Heating Facility / intact (point)**



Symbol Graphic

Symbol Placement Instructions: Origin: Center of symbol  
Symbol Type: Simple

Component Ref #:	P00006	Component Type:	Point - Simple	Color Token:	Black
Description:	Black filled square with all sides 0.8mm				
Parameters:					
Length:	0.8mm				
Note:	The component is a square and is filled with the solid color.				

Symbol Rules

<p>Reference #: <b>PS-04300</b></p> <p>Description: <b>Heating Facility / intact (point)</b></p>	<p>Criteria:</p> <p>Condition of Facility [FUN] = (Fully Functional [6], Unknown [0])</p>
--	---

Label Rules

Label Placement Rules (see Annex J): LP-3505, LP-4813, LP-9999

<p>Reference #: <b>PL-04300_1</b></p> <p>Description: <b>Heating Facility / intact (point)</b></p> <p>Label String: [Name] "Heating facility"</p> <p>Characteristics: 1, 1 1 (Black, Condensed, 6 pt, Mixed case)</p>	<p>Criteria:</p> <p>N/A</p>
---	-----------------------------

Symbol Samples



**Heating Facility / not intact (point)**



Symbol Graphic

Symbol Placement Instructions: Origin: Center of symbol

Symbol Type: Simple

Component Ref #:	P00173	Component Type:	Point - Shape	Color Token:	Black/Black-12
Description:	Not intact square 0.8mm				
<a href="#">Parameters:</a>					
Note:	See Annex H for detailed drawing instructions.				

### Symbol Rules

Reference #:	Description:	Criteria:
PS-04907	Heating Facility / not intact (point)	Condition of Facility [FUN] = (Abandoned [2], Damaged [13], Destroyed [3], Dismantled [4], Under Construction [1])

### Label Rules

Label Placement Rules (see Annex J): LP-3505

Reference #:	Description:	Criteria:
PL-04907_1	Heating Facility / not intact (point)	N/A

Label String: "Heating facility"  
 Characteristics: 1  
 1 (Black, Condensed, 6 pt, Mixed case)

### Symbol Samples

Heating facility

## Hedgerow (EA020)

Generalization Rules (see Annex J): GA-9999

### Hedgerow / all (line)

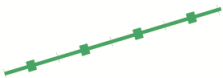

Symbol Graphic

Symbol Placement Instructions: The symbol is applied to the geometry of the feature.

Symbol Type: Complex

Repeating Point and Interval: Component P00235 has an initial offset of 1.0mm; after that 2.0mm.

Note: Component P00235 is centered perpendicular to Component L00361.

Component Ref #:	L00361	Component Type:	Line - Simple	Color Token:	Green362
Description:	Green362 0.15mm Solid Line				
<a href="#">Parameters:</a>					
Line Weight:	0.15mm				

Component Ref #:	P00235	Component Type:	Point - Simple	Color Token:	Green362
Description:	Green362 0.35mm length line with a 0.45mm lineweight				
<a href="#">Parameters:</a>					
Line Weight:	0.45mm				
Length:	0.35mm				

### Symbol Rules

Reference #:	Description:	Criteria:
PS-04307	Hedgerow / all (line)	All

### Symbol Samples

## Helipad (GB030)

### Helipad / non-hospital (point)



Symbol Graphic

Symbol Placement Instructions: Origin: Center of symbol

Symbol Type: Simple

Component Ref #: P00090      Component Type: Point - Shape      Color Token: Blue072  
 Description: Helipad  
[Parameters:](#)  
 Note: See Annex H for detailed drawing instructions.

#### Symbol Rules

Reference #:	Description:	Criteria:
PS-04326	Helipad / non-hospital (point)	Helipad Associated Facility [HAF] = (Heliport [1], Land Aerodrome [2], Non-hospital Building [4], Offshore Construction [9], Other [999], Rig [6], Unknown [0])

#### Label Rules

Label Placement Rules (see Annex J): LP-3505, LP-9950, LP-9998, LP-9999

Reference #:	Description:	Criteria:
PL-04326_1	Helipad / non-hospital (point)	Condition of Facility [FUN] = (Abandoned [2], Damaged [13], Destroyed [3], Dismantled [4], Under Construction [1])
	Label String: "[Condition of Facility]"	
	Characteristics: 26, 26, 26 26 (Blue072, Condensed, 7 pt, Lower case)	

#### Symbol Samples

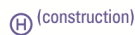

### Helipad / hospital (point)



Symbol Graphic

Symbol Placement Instructions: Origin: Center of symbol

Symbol Type: Simple

Component Ref #: P00089      Component Type: Point - Shape      Color Token: Blue072  
 Description: Helipad at hospital  
[Parameters:](#)  
 Note: See Annex H for detailed drawing instructions.

#### Symbol Rules

Reference #:	Description:	Criteria:
PS-04327	Helipad / hospital (point)	Helipad Associated Facility [HAF] = Hospital [3]

#### Label Rules

Label Placement Rules (see Annex J): LP-3505, LP-9950, LP-9998, LP-9999



Reference #: Description:  
**PL-04327\_1 Helipad / hospital (point)**

Criteria:  
 Condition of Facility [FUN] = (Abandoned [2], Damaged [13], Destroyed [3], Dismantled [4], Under Construction [1])

Label String: "[Condition of Facility]"  
 Characteristics: 26, 26, 26  
 26 (Blue072, Condensed, 7 pt, Lower case)

Symbol Samples



**Heliport (GB035)**

Generalization Rules (see Annex J): GA-9999

**Heliport / all (area)**



Symbol Graphic

Symbol Placement Instructions: The symbol is applied to the geometry of the feature.  
 Symbol Type: Simple

Component Ref #:	L00210	Component Type:	Line - Styled	Color Token:	Black
Description:	Black 0.1mm Dashed line (0.1mm wt, 1.0mm dash, 0.5mm gap)				
Parameters:					
Line Weight:	0.1mm	Dash Length:	1.0mm	Dash Spacing:	0.5mm

Symbol Rules

Reference #: Description: Criteria:  
**PS-04328 Heliport / all (area)** All

Label Rules

Label Placement Rules (see Annex J): LP-3506, LP-9950, LP-9999

Reference #: Description: Criteria:  
**PL-04328\_1 Heliport / intact (area)** Condition of Facility [FUN] = (Fully Functional [6], Unknown [0])

Label String: [Name] [ICAO Location Indicator]  
 [Aerodrome Elevation]  
 Characteristics: 24, 29  
 26  
 24 (Blue072, Condensed, 7 pt, Mixed case)  
 26 (Blue072, Condensed, 7 pt, Lower case)  
 29 (Blue072, Condensed, 7 pt, Upper case)

**PL-04328\_2 Heliport / not intact (area)** Condition of Facility [FUN] = (Abandoned [2], Damaged [13], Destroyed [3], Dismantled [4], Under Construction [1])

Label String: [Name] [ICAO Location Indicator]  
 "[Condition of Facility]"  
 [Aerodrome Elevation]  
 Characteristics: 24, 29  
 26, 26, 26  
 26  
 24 (Blue072, Condensed, 7 pt, Mixed case)  
 26 (Blue072, Condensed, 7 pt, Lower case)  
 29 (Blue072, Condensed, 7 pt, Upper case)

Symbol Samples



## Holding Pen (AJ030)

Generalization Rules (see Annex J): GA-9999

### Holding Pen / all (area)

Symbol Placement Instructions: The symbol is applied to the geometry of the feature.

Symbol Type: Simple



Symbol Graphic

Component Ref #:	L00240	Component Type:	Line - Simple	Color Token:	Dk-Brown1815
Description:	Dk-Brown1815 0.15mm Solid Line				
<u>Parameters:</u>					
Line Weight:	0.15mm				

#### Symbol Rules

Reference #:	Description:	Criteria:
PS-04048	Holding Pen / all (area)	All

#### Label Rules

Label Placement Rules (see Annex J): LP-3505

Reference #:	Description:	Criteria:
PL-04048_1	Holding Pen / all (area)	N/A

Label String: "Holding Pen"  
 Characteristics: 1  
 1 (Black, Condensed, 6 pt, Mixed case)

#### Symbol Samples



### Holding Pen / all (point)

Symbol Placement Instructions: Origin: Center of symbol

Symbol Type: Simple



Symbol Graphic

Component Ref #:	P00168	Component Type:	Point - Simple	Color Token:	Dk-Brown1815
Description:	Holding pen				
<u>Parameters:</u>					
Line Weight:	0.15mm				
Length:	0.8mm				
Note:	The component is an open square.				

#### Symbol Rules

Reference #:	Description:	Criteria:
--------------	--------------	-----------

Symbol Samples

**Hop Field (EA055)**

Generalization Rules (see Annex J): GA-9999

**Hop Field / all (area)**

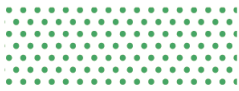

Symbol Graphic

Symbol Placement Instructions: The symbol is applied to the geometry of the feature.

Symbol Type: Simple

Component Ref #:	A00029	Component Type:	Area - Pattern	Color Token:	Green362
Description:	Green362 Vineyard / Hops Fill				
Parameters:	<a href="#">Parameters:</a>				
Area Pattern:	AP-77, see Annex I				

Symbol Rules

Reference #:	Description:	Criteria:
PS-04316	Hop Field / all (area)	All

Label Rules

Label Placement Rules (see Annex J): LP-3506

Reference #:	Description:	Criteria:
PL-04316_1	Hop Field / all (area)	N/A

Label String: "Hops"  
 Characteristics: 1  
 1 (Black, Condensed, 6 pt, Mixed case)

Symbol Samples



**Hut (AL099)**

**Hut / all (point)**



Symbol Graphic

Symbol Placement Instructions: Origin: Center of symbol

Symbol Type: Simple

Component Ref #:	P00284	Component Type:	Point - Simple	Color Token:	Black
Description:	Hut				
Parameters:	<a href="#">Parameters:</a>				

Line Weight: 0.1mm  
 Length: 0.6mm  
 Note: The component is an open square.

Symbol Rules

Reference #:	Description:	Criteria:
PS-04545	Hut / all (point)	All

Symbol Samples

**Hydrocarbons Field (AA052)**

Generalization Rules (see Annex J): GA-9999

**Hydrocarbons Field / all (area)**



Symbol Graphic

Symbol Placement Instructions: The symbol is applied to the geometry of the feature.

Symbol Type: Simple

Component Ref #:	L00210	Component Type:	Line - Styled	Color Token:	Black
Description:	Black 0.1mm Dashed line (0.1mm wt, 1.0mm dash, 0.5mm gap)				
Parameters:					
Line Weight:	0.1mm	Dash Length:	1.0mm	Dash Spacing:	0.5mm

Symbol Rules

Reference #:	Description:	Criteria:
PS-04548	Hydrocarbons Field / all (area)	All

Label Rules

Label Placement Rules (see Annex J): LP-3506, LP-4813, LP-9999

Reference #:	Description:	Criteria:
PL-04548_1	Hydrocarbons Field / all (area)	N/A

Label String: [Name] "Hydrocarbons field"  
 Characteristics: 1, 1  
 1 (Black, Condensed, 6 pt, Mixed case)

Symbol Samples

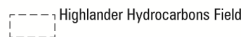
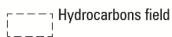

**Ice Cliff (BJ040)**

Generalization Rules (see Annex J): GA-9999

**Ice Cliff / all (line)**



Symbol Graphic

**Symbol Placement Instructions:** The symbol is applied to the geometry of the feature.

**Symbol Type:** Complex

**Repeating Point and Interval:** Component P00055 has an initial offset of 0.0mm; after that 0.5mm.

**Note:** Component P00055 is perpendicular to and on the downhill side of Component L00015.

<b>Component Ref #:</b>	L00015	<b>Component Type:</b>	Line - Simple	<b>Color Token:</b>	Cyan
<b>Description:</b>	Cyan 0.2mm Solid Line				
<b>Parameters:</b>					
<b>Line Weight:</b>	0.2mm				

<b>Component Ref #:</b>	P00055	<b>Component Type:</b>	Point - Simple	<b>Color Token:</b>	Cyan
<b>Description:</b>	Cyan 0.5mm length line with a 0.1mm lineweight				
<b>Parameters:</b>					
<b>Line Weight:</b>	0.1mm				
<b>Length:</b>	0.5mm				

**Symbol Rules**

<b>Reference #:</b>	<b>Description:</b>	<b>Criteria:</b>
PS-04229	Ice Cliff / all (line)	All

**Symbol Samples**



**Ice Peak (BJ060)**

**Ice Peak / all (point)**



Symbol Graphic

**Symbol Placement Instructions:** Origin: Center of symbol

**Symbol Type:** Simple

<b>Component Ref #:</b>	P00066	<b>Component Type:</b>	Point - Shape	<b>Color Token:</b>	Dk-Brown1815
<b>Description:</b>	Ice peak not frozen water				
<b>Parameters:</b>					
<b>Note:</b>	See Annex H for detailed drawing instructions.				

**Symbol Rules**

<b>Reference #:</b>	<b>Description:</b>	<b>Criteria:</b>
PS-04230	Ice Peak / all (point)	All

**Symbol Samples**



**Ice Route (AQ075)**

Generalization Rules (see Annex J): GA-9999

## Ice Route / all (line)



Symbol Graphic

Symbol Placement Instructions: The symbol is applied to the geometry of the feature.

Symbol Type: Simple

Component Ref #:	L00032	Component Type:	Line - Styled	Color Token:	Black
Description:	Black 0.2mm Dashed Line (0.2mm wt, 2.0mm dash, 0.5mm gap)				
<u>Parameters:</u>					
Line Weight:	0.2mm	Dash Length:	2.0mm	Dash Spacing:	0.5mm

### Symbol Rules

Reference #:	Description:	Criteria:
PS-04138	Ice Route / all (line)	All

### Label Rules

Label Placement Rules (see Annex J): LP-3630, LP-4813, LP-9999

Reference #:	Description:	Criteria:
PL-04138_1	Ice Route / all (line)	N/A

Label String: [Name] "ICE ROUTE"  
 Characteristics: 27, 27  
 27 (Black, Light Condensed, Italic, 6 pt, Upper case)

### Symbol Samples

----- ICE ROUTE -----

----- MADELINE ISLAND ICE ROUTE -----

## Island (BA030)

Generalization Rules (see Annex J): GA-9999

## Island / all (area)

*[NAM]*

Symbol Graphic

Symbol Placement Instructions: Text label only. No graphic parameters

Symbol Type: Simple

### Symbol Rules

Reference #:	Description:	Criteria:
PS-04164	Island / all (area)	All

### Label Rules

Label Placement Rules (see Annex J): LP-0050, LP-3506, LP-9999

Reference #:	Description:	Criteria:
PL-04164_1	Island / all (area)	N/A

Label String: [Name]  
 Characteristics: 12  
 12 (Black, Condensed, Italic, 6-16 pt, Upper case)

### Symbol Samples

MAUI

KODIAK ISLAND

Shown with Land Water Boundary and Tidal Water:



## Lake (BH080)

Generalization Rules (see Annex J): GA-9999

### Lake / perennial (area)



Symbol Graphic

Symbol Placement Instructions: The symbol is applied to the geometry of the feature.

Symbol Type: Complex

Note: Component L00015 is applied to the perimeter and is filled with Component A00007.

Component Ref #:	A00007	Component Type:	Area - Fill	Color Token:	Cyan-31
Description:	Cyan-31 area fill				
Parameters:					
Screen Angle:	45 degrees				
Screen Percent:	31%				

Component Ref #:	L00015	Component Type:	Line - Simple	Color Token:	Cyan
Description:	Cyan 0.2mm Solid Line				
Parameters:					
Line Weight:	0.2mm				

### Symbol Rules

Reference #:	Description:	Criteria:
PS-04764	Lake / perennial (area)	Hydrologic Persistence [HYP] = (Perennial [1], Unknown [0])

### Label Rules

Label Placement Rules (see Annex J): LP-0050, LP-3506, LP-9999

Reference #:	Description:	Criteria:
PL-04764_1	Lake / perennial / fresh (area)	Water Type [SCC] = (Fresh [11], Unknown [0])

Label String: [Name]  
 Characteristics: 37  
 37 (Cyan, Condensed, Italic, 7-16 pt, Upper case)

PL-04764_2	Lake / perennial / salt (area)	Water Type [SCC] = (Brackish [12], Salty [10])
------------	--------------------------------	--

Label String: [Name] "(salt)"  
 Characteristics: 37, 33  
 37 (Cyan, Condensed, Italic, 7-16 pt, Upper case)  
 33 (Cyan, Condensed, Italic, 7-16 pt, Lower case)

### Symbol Samples



### Lake / intermittent, dry (area)



Symbol Graphic

Symbol Placement Instructions: The symbol is applied to the geometry of the feature.

Symbol Type: Complex

Note: Component L00041 is applied to the perimeter and is filled with Component A00020.

Component Ref #:	A00020	Component Type:	Area - Pattern	Color Token:	Cyan
Description:	Cyan Dry Drainage Fill				
Parameters:					
Area Pattern:	AP-95, see Annex I				
Component Ref #:	L00041	Component Type:	Line - Styled	Color Token:	Cyan
Description:	Cyan 0.2mm Dashed Line (0.2mm wt, 2.0mm dash, 0.5mm gap)				
Parameters:					
Line Weight:	0.2mm	Dash Length:	2.0mm	Dash Spacing:	0.5mm

Symbol Rules

Reference #:	Description:	Criteria:
PS-04765	Lake / intermittent, dry (area)	Hydrologic Persistence [HYP] = (Dry [4], Intermittent [2])

Label Rules

Label Placement Rules (see Annex J): LP-0050, LP-3506, LP-9999		
Reference #:	Description:	Criteria:
PL-04765_1	Lake / intermittent, dry / fresh (area)	Water Type [SCC] = (Fresh [11], Unknown [0])
	Label String: [Name]	
	Characteristics: 37 37 (Cyan, Condensed, Italic, 7-16 pt, Upper case)	
PL-04765_2	Lake / intermittent, dry / salt (area)	Water Type [SCC] = (Brackish [12], Salty [10])
	Label String: [Name] "(salt)"	
	Characteristics: 37, 33 37 (Cyan, Condensed, Italic, 7-16 pt, Upper case) 33 (Cyan, Condensed, Italic, 7-16 pt, Lower case)	

Symbol Samples



COYOTE LAKE



MAKGADIKGADI PANS  
(salt)

Land Aerodrome (GB005)

Generalization Rules (see Annex J): GA-9999

Land Aerodrome / all (area)



Symbol Graphic

Symbol Placement Instructions: The symbol is applied to the geometry of the feature.

Symbol Type: Simple

Note: The label string for the associated Runway is included as part of the label string for Land Aerodrome.

Component Ref #:	L00210	Component Type:	Line - Styled	Color Token:	Black
Description:	Black 0.1mm Dashed line (0.1mm wt, 1.0mm dash, 0.5mm gap)				
Parameters:					
Line Weight:	0.1mm	Dash Length:	1.0mm	Dash Spacing:	0.5mm

Symbol Rules

Reference #:	Description:	Criteria:
--------------	--------------	-----------



PS-04317 Land Aerodrome / all (area) All

Label Rules

Label Placement Rules (see Annex J): LP-9950, LP-9990, LP-9999

Reference #: Description:

Criteria:

PL-04317\_1 Land Aerodrome / intact (area)

Condition of Facility [FUN] = (Fully Functional [6], Unknown [0])

Label String: [Name] [ICAO Location Indicator]  
{label string of associated Runway}  
[Aerodrome Elevation]

Characteristics: 24, 29  
24  
26  
24 (Blue072, Condensed, 7 pt, Mixed case)  
26 (Blue072, Condensed, 7 pt, Lower case)  
29 (Blue072, Condensed, 7 pt, Upper case)

PL-04317\_2 Land Aerodrome / not intact (area)

Condition of Facility [FUN] = (Abandoned [2], Damaged [13], Destroyed [3], Dismantled [4], Under Construction [1])

Label String: [Name] [ICAO Location Indicator]  
{label string of associated Runway}  
"("[Condition of Facility]")"  
[Aerodrome Elevation]

Characteristics: 24, 29  
24  
26  
26  
24 (Blue072, Condensed, 7 pt, Mixed case)  
26 (Blue072, Condensed, 7 pt, Lower case)  
29 (Blue072, Condensed, 7 pt, Upper case)

Symbol Samples

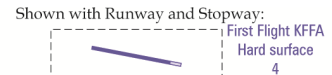

Land Subject To Inundation (BH090)

Generalization Rules (see Annex J): GA-9999

Land Subject To Inundation / not controlled (area)



Symbol Graphic

Symbol Placement Instructions: The symbol is applied to the geometry of the feature.

Symbol Type: Simple

Component Ref #: A00015 Component Type: Area - Pattern Color Token: Cyan  
Description: Cyan Land Subject to Inundation Fill  
Parameters:  
Area Pattern: AP-10, see Annex I

Symbol Rules

Reference #: Description:

Criteria:

PS-04192 Land Subject To Inundation / not controlled (area)

Controlled [CNS] = (Uncontrolled [1000], Unknown [0])

Symbol Samples



### Land Subject To Inundation / controlled (area)



Symbol Graphic

**Symbol Placement Instructions:** The symbol is applied to the geometry of the feature.

**Symbol Type:** Complex

**Note:** Component L00041 is applied to the perimeter and is filled with Component A00015.

<b>Component Ref #:</b>	A00015	<b>Component Type:</b>	Area - Pattern	<b>Color Token:</b>	Cyan
<b>Description:</b>	Cyan Land Subject to Inundation Fill				
<b>Parameters:</b>					
<b>Area Pattern:</b>	AP-10, see Annex I				

<b>Component Ref #:</b>	L00041	<b>Component Type:</b>	Line - Styled	<b>Color Token:</b>	Cyan
<b>Description:</b>	Cyan 0.2mm Dashed Line (0.2mm wt, 2.0mm dash, 0.5mm gap)				
<b>Parameters:</b>					
<b>Line Weight:</b>	0.2mm	<b>Dash Length:</b>	2.0mm	<b>Dash Spacing:</b>	0.5mm

#### Symbol Rules

<b>Reference #:</b>	<b>Description:</b>	<b>Criteria:</b>
PS-04193	Land Subject To Inundation / controlled (area)	Controlled [CNS] = Controlled [1001]

#### Symbol Samples



### Land Water Boundary (BA010)

Generalization Rules (see Annex J): GA-9999

### Land Water Boundary / other (line)



Symbol Graphic

**Symbol Placement Instructions:** The symbol is applied to the geometry of the feature.

**Symbol Type:** Simple

<b>Component Ref #:</b>	L00015	<b>Component Type:</b>	Line - Simple	<b>Color Token:</b>	Cyan
<b>Description:</b>	Cyan 0.2mm Solid Line				
<b>Parameters:</b>					
<b>Line Weight:</b>	0.2mm				

#### Symbol Rules

<b>Reference #:</b>	<b>Description:</b>	<b>Criteria:</b>
PS-04162	Land Water Boundary / other (line)	Shoreline Type [SLT] = (Building Rubble [11], Other [999], Sandy [13], Shingly [14], Stony [10], Unknown [0])

#### Symbol Samples



## Land Water Boundary / mangrove, marsh (line)

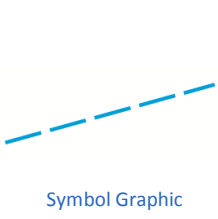

**Symbol Placement Instructions:** The symbol is applied to the geometry of the feature.

**Symbol Type:** Simple

<b>Component Ref #:</b>	L00041	<b>Component Type:</b>	Line - Styled	<b>Color Token:</b>	Cyan
<b>Description:</b>	Cyan 0.2mm Dashed Line (0.2mm wt, 2.0mm dash, 0.5mm gap)				
<b>Parameters:</b>					
<b>Line Weight:</b>	0.2mm	<b>Dash Length:</b>	2.0mm	<b>Dash Spacing:</b>	0.5mm

### Symbol Rules

<b>Reference #:</b>	<b>Description:</b>	<b>Criteria:</b>
PS-04163	Land Water Boundary / mangrove, marsh (line)	Shoreline Type [SLT] = (Mangrove [6], Marshy [8])

### Symbol Samples



## Launch Pad (GB040)

### Launch Pad / all (point)



Symbol Graphic

**Symbol Placement Instructions:** Origin: Center of symbol

**Symbol Type:** Simple

<b>Component Ref #:</b>	P00010	<b>Component Type:</b>	Point - Shape	<b>Color Token:</b>	Black
<b>Description:</b>	Located object				
<b>Parameters:</b>					
<b>Note:</b>	See Annex H for detailed drawing instructions.				

### Symbol Rules

<b>Reference #:</b>	<b>Description:</b>	<b>Criteria:</b>
PS-04315	Launch Pad / all (point)	All

### Label Rules

**Label Placement Rules (see Annex J):** LP-3505, LP-9950

<b>Reference #:</b>	<b>Description:</b>	<b>Criteria:</b>
PL-04315_1	Launch Pad / intact (point)	Condition of Facility [FUN] = (Fully Functional [6], Unknown [0])

**Label String:** "Launch pad"  
**Characteristics:** 1  
 1 (Black, Condensed, 6 pt, Mixed case)

**PL-04315\_2 Launch Pad / not intact (point)**

Condition of Facility [FUN] = (Abandoned [2], Damaged [13], Destroyed [3], Dismantled [4], Under Construction [1])

**Label String:** "Launch pad" "["[Condition of Facility]"  
**Characteristics:** 1, 22, 22, 22  
 1 (Black, Condensed, 6 pt, Mixed case)  
 22 (Black, Condensed, 6 pt, Lower case)

Symbol Samples

○ Launch pad

**Leader Line (No Code)**

**Leader Line / black (curve)**



**Symbol Placement Instructions:** The symbol is manually positioned to point from a label to a feature symbol.

**Symbol Type:** Simple

**Note:** The color of the leader matches the color of the feature symbol it is pointing to.

<b>Component Ref #:</b>	L00007	<b>Component Type:</b>	Line - Simple	<b>Color Token:</b>	Black
<b>Description:</b>	Black 0.1mm Solid Line				
<b>Parameters:</b>					
<b>Line Weight:</b>	0.1mm				

Symbol Rules

<b>Reference #:</b>	<b>Description:</b>	<b>Criteria:</b>
PS-04948	Leader Line / black (curve)	Portray as needed

Symbol Samples

Shown with Launch pad:  
 Launch pad ○

**Leader Line / cyan (curve)**



**Symbol Placement Instructions:** The symbol is manually positioned to point from a label to a feature symbol.

**Symbol Type:** Simple

**Note:** The color of the leader matches the color of the feature symbol it is pointing to.

<b>Component Ref #:</b>	L00108	<b>Component Type:</b>	Line - Simple	<b>Color Token:</b>	Cyan
<b>Description:</b>	Cyan 0.1mm Solid Line				
<b>Parameters:</b>					
<b>Line Weight:</b>	0.1mm				

Symbol Rules

<b>Reference #:</b>	<b>Description:</b>	<b>Criteria:</b>
PS-04949	Leader Line / cyan (curve)	Portray as needed

Symbol Samples



Shown with Rapids:  
Snake Rapids

Leader Line / aero blue (curve)



Symbol Graphic

Symbol Placement Instructions: The symbol is manually positioned to point from a label to a feature symbol.

Symbol Type: Simple

Note: The color of the leader matches the color of the feature symbol it is pointing to.

Component Ref #:	L00217	Component Type:	Line - Simple	Color Token:	Blue072
Description:	Blue072 0.1mm Solid Line				
Parameters:					
Line Weight:	0.1mm				

Symbol Rules

Reference #:	Description:	Criteria:
PS-04950	Leader Line / aero blue (curve)	Portray as needed

Symbol Samples

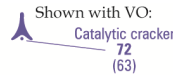

Shown with VO:  
Catalytic cracker  
72  
(63)

Lock (BI030)

Generalization Rules (see Annex J): GA-9999, GC-9990, GC-9991

Lock / all (area)



Symbol Graphic

Symbol Placement Instructions: The symbol is applied to the geometry of the feature.

Symbol Type: Compound

Note: Component L00010 is applied to the longest edges of the surface geometry. Component L00451 is connected at each end of component L00010 with apex of each "V" pointing upstream.

Component Ref #:	L00451	Component Type:	Line - Simple	Color Token:	Black
Description:	Black surface lock "V" (0.15mm wt)				
Parameters:					
Line Weight:	0.15mm				
Note:	Each leg is equal and based on width of the surface geometry, and is connected to form a "V" at a 90 degree angle.				

Component Ref #:	L00010	Component Type:	Line - Simple	Color Token:	Black
Description:	Black 0.25mm Solid Line				
Parameters:					
Line Weight:	0.25mm				

Symbol Rules

Reference #:	Description:	Criteria:
PS-04221	Lock / all (area)	All

Label Rules

Label Placement Rules (see Annex J): LP-3505, LP-4813, LP-9950, LP-9999

Reference #: Description:  
**PL-04221\_1 Lock / intact (area)**

Criteria:  
 Condition of Facility [FUN] = (Fully Functional [6], Unknown [0])

Label String: [Name] "Lock"  
 Characteristics: 1, 1  
 1 (Black, Condensed, 6 pt, Mixed case)

**PL-04221\_2 Lock / not intact (area)**

Condition of Facility [FUN] = (Abandoned [2], Damaged [13], Destroyed [3], Dismantled [4], Under Construction [1])

Label String: [Name] "Lock" "["[Condition of Facility]""]  
 Characteristics: 1, 1, 22, 22, 22  
 1 (Black, Condensed, 6 pt, Mixed case)  
 22 (Black, Condensed, 6 pt, Lower case)

Symbol Samples

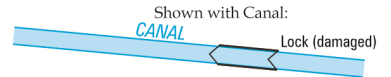

Lock / all (line)



Symbol Graphic

Symbol Placement Instructions: The symbol is applied to the geometry of the feature.

Symbol Type: Complex

Note: Apex of Component P00105 is fixed at the start and end of Component L00145 and each "V" points upstream. The 90 degree angle of the "V" is bisected equally by the line component.

Component Ref #:	L00145	Component Type:	Line - Simple	Color Token:	N/A
Description:	0mm Line weight line. This is a place holder for lines that do not have any line component only a point element at each end of the line.				
Parameters:					
Line Weight:	0.0mm				

Component Ref #:	P00105	Component Type:	Point - Shape	Color Token:	Black
Description:	Lock/pedestrian bridge/sluice gate "V"				
Parameters:					
Note:	See Annex H for detailed drawing instructions.				

Symbol Rules

Reference #:	Description:	Criteria:
PS-04222	Lock / all (line)	All

Symbol Samples



Shown with Canal:



Lock / all (point)



Symbol Graphic

Symbol Placement Instructions: Origin: Center of symbol

Symbol Type: Simple

Note: Component P00035 is centered on the associated drainage symbol with apex pointing upstream.

Component Ref #: P00035      Component Type: Point - Shape      Color Token: Black  
 Description: Basin gate/lock  
[Parameters:](#)  
 Note: See Annex H for detailed drawing instructions.

Symbol Rules

Reference #: Description: Criteria:  
**PS-04223** Lock / all (point) All

Symbol Samples

«      Shown with Canal:      «

**Mangrove Swamp (ED030)**

Generalization Rules (see Annex J): GA-9999

**Mangrove Swamp (area)**



Symbol Graphic

Symbol Placement Instructions: The symbol is applied to the geometry of the feature.

Symbol Type: Complex

Note: Component L00041 is applied to the perimeter and is filled with Components A00007 and A00025. Display level from bottom to top: Component A00007; Component A00025.

Component Ref #: A00007      Component Type: Area - Fill      Color Token: Cyan-31  
 Description: Cyan-31 area fill  
[Parameters:](#)  
 Screen Angle: 45 degrees  
 Screen Percent: 31%

Component Ref #: A00025      Component Type: Area - Pattern      Color Token: Green362  
 Description: Green362 Mangrove Fill  
[Parameters:](#)  
 Area Pattern: AP-8, see Annex I

Component Ref #: L00041      Component Type: Line - Styled      Color Token: Cyan  
 Description: Cyan 0.2mm Dashed Line (0.2mm wt, 2.0mm dash, 0.5mm gap)  
[Parameters:](#)  
 Line Weight: 0.2mm      Dash Length: 2.0mm      Dash Spacing: 0.5mm

Symbol Rules

Reference #: Description: Criteria:  
**PS-04302** Mangrove Swamp (area) All

Label Rules

Label Placement Rules (see Annex J): LP-0050, LP-3506, LP-9999

Reference #: Description: Criteria:  
**PL-04302\_1** Mangrove Swamp (area) N/A

Label String: [Name]  
 Characteristics: 39  
 39 (Black, Condensed, Italic, 7-16 pt, Upper case)

Symbol Samples



## Mariculture Site (BH050)

Generalization Rules (see Annex J): GA-9999, GC-9999

### Mariculture Site / all (area)



Symbol Graphic

Symbol Placement Instructions: The symbol is applied to the geometry of the feature.

Symbol Type: Simple

Component Ref #:	L00210	Component Type:	Line - Styled	Color Token:	Black
Description:	Black 0.1mm Dashed line (0.1mm wt, 1.0mm dash, 0.5mm gap)				
Parameters:					
Line Weight:	0.1mm	Dash Length:	1.0mm	Dash Spacing:	0.5mm

#### Symbol Rules

Reference #:	Description:	Criteria:
PS-04767	Mariculture Site / all (area)	All

#### Label Rules

Label Placement Rules (see Annex J): LP-3506, LP-4813, LP-9950, LP-9999

Reference #:	Description:	Criteria:
PL-04767_1	Mariculture Site / intact (area)	Condition of Facility [FUN] = (Fully Functional [6], Unknown [0])
	Label String: [Name] "Mariculture site"	
	Characteristics: 1, 1 1 (Black, Condensed, 6 pt, Mixed case)	
PL-04767_2	Mariculture Site / not intact (area)	Condition of Facility [FUN] = (Abandoned [2], Damaged [13], Destroyed [3], Dismantled [4], Under Construction [1])
	Label String: [Name] "Mariculture site" "["[Condition of Facility]"	
	Characteristics: 1, 1, 22, 22, 22 1 (Black, Condensed, 6 pt, Mixed case) 22 (Black, Condensed, 6 pt, Lower case)	

#### Symbol Samples

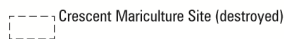

### Mariculture Site / intact (point)



Symbol Graphic

Symbol Placement Instructions: Origin: Center of symbol

Symbol Type: Simple

Component Ref #:	P00006	Component Type:	Point - Simple	Color Token:	Black
Description:	Black filled square with all sides 0.8mm				
Parameters:					



Length: 0.8mm

Note: The component is a square and is filled with the solid color.

Symbol Rules

Reference #:	Description:	Criteria:
PS-04779	Mariculture Site / intact (point)	Condition of Facility [FUN] = (Fully Functional [6], Unknown [0])

Label Rules

Label Placement Rules (see Annex J): LP-3505, LP-4813, LP-9999

Reference #:	Description:	Criteria:
PL-04779_1	Mariculture Site / intact (point)	N/A

Label String: [Name] "Mariculture site"  
 Characteristics: 1, 1  
 1 (Black, Condensed, 6 pt, Mixed case)

Symbol Samples



Mariculture Site / not intact (point)



Symbol Graphic

Symbol Placement Instructions: Origin: Center of symbol  
 Symbol Type: Simple

Component Ref #:	P00173	Component Type:	Point - Shape	Color Token:	Black/Black-12
Description:	Not intact square 0.8mm				
Parameters:					
Note:	See Annex H for detailed drawing instructions.				

Symbol Rules

Reference #:	Description:	Criteria:
PS-04780	Mariculture Site / not intact (point)	Condition of Facility [FUN] = (Abandoned [2], Damaged [13], Destroyed [3], Dismantled [4], Under Construction [1])

Label Rules

Label Placement Rules (see Annex J): LP-3505

Reference #:	Description:	Criteria:
PL-04780_1	Mariculture Site / not intact (point)	N/A

Label String: "Mariculture site"  
 Characteristics: 1  
 1 (Black, Condensed, 6 pt, Mixed case)

Symbol Samples



Maritime Signal Station (BB155)

Maritime Signal Station / intact (point)

Symbol Placement Instructions: Origin: Center of symbol

Symbol Type: Simple



Symbol Graphic

Component Ref #: P00006      Component Type: Point - Simple      Color Token: Black  
 Description: Black filled square with all sides 0.8mm  
[Parameters:](#)  
 Length: 0.8mm  
 Note: The component is a square and is filled with the solid color.

Symbol Rules

Reference #: Description: Criteria:  
**PS-04599** Maritime Signal Station / intact (point) Condition of Facility [FUN] = (Fully Functional [6], Unknown [0])

Label Rules

Label Placement Rules (see Annex J): LP-3505, LP-4813, LP-9999

Reference #: Description: Criteria:  
**PL-04599\_1** Maritime Signal Station / intact / known (point) Maritime Station Type [STA] = (Bridge Signal Station [29], Coast Guard Station [1], Fireboat Station [2], Ice Signal Station [4], International Port Signals Station [32], Lock Signal Station [30], Military Practice Signal Station [33], Pilot Lookout Station [37], Pilot Station [11], Port Control Station [6], Radar Surveillance Station [36], Rescue Station [5], Signal Station [13], Storm Signal Station [15], Tidal Stream Station [27], Tide Station [17], Time Signal Station [19], Traffic Signal Station [28], Warning Signal Station [35], Water-police Station [3], Weather Signal Station [21])

Label String: [Name] [Maritime Station Type]  
 Characteristics: 1, 1  
 1 (Black, Condensed, 6 pt, Mixed case)

**PL-04599\_2** Maritime Signal Station / intact / unknown (point) Maritime Station Type [STA] = (Other [999], Unknown [0])

Label String: [Name] "Signal station"  
 Characteristics: 1, 1  
 1 (Black, Condensed, 6 pt, Mixed case)

Symbol Samples

Signal station

Fairfax Rescue Station

Maritime Signal Station / not intact (point)

Symbol Placement Instructions: Origin: Center of symbol

Symbol Type: Simple



Symbol Graphic

Component Ref #: P00293      Component Type: Point - Shape      Color Token: Black/Black-12  
 Description: Not intact square 0.6mm  
[Parameters:](#)  
 Note: See Annex H for detailed drawing instructions.

Symbol Rules

Reference #: Description: Criteria:

**PS-04103 Maritime Signal Station / not intact (point)**

Condition of Facility [FUN] = (Abandoned [2], Damaged [13], Destroyed [3], Dismantled [4], Under Construction [1])

**Label Rules**

Label Placement Rules (see Annex J): LP-3505, LP-4813, LP-9999

Reference #: Description:

**PL-04103\_1 Maritime Signal Station / not intact / known (point)**

Criteria:

Maritime Station Type [STA] = (Bridge Signal Station [29], Coast Guard Station [1], Fireboat Station [2], Ice Signal Station [4], International Port Signals Station [32], Lock Signal Station [30], Military Practice Signal Station [33], Pilot Lookout Station [37], Pilot Station [11], Port Control Station [6], Radar Surveillance Station [36], Rescue Station [5], Signal Station [13], Storm Signal Station [15], Tidal Stream Station [27], Tide Station [17], Time Signal Station [19], Traffic Signal Station [28], Warning Signal Station [35], Water-police Station [3], Weather Signal Station [21])

Label String: [Name] [Maritime Station Type]

Characteristics: 1, 1  
1 (Black, Condensed, 6 pt, Mixed case)

**PL-04103\_2 Maritime Signal Station / not intact / unknown (point)**

Maritime Station Type [STA] = (Other [999], Unknown [0])

Label String: [Name] "Signal station"

Characteristics: 1, 1  
1 (Black, Condensed, 6 pt, Mixed case)

**Symbol Samples**

□ Signal station

□ Kitty Hawk Coast Guard Station

**Marsh (ED010)**

Generalization Rules (see Annex J): GA-9999

**Marsh / all (area)**



Symbol Graphic

Symbol Placement Instructions: The symbol is applied to the geometry of the feature.

Symbol Type: Complex

Note: Component P00167 is applied to the perimeter with a spacing of 0.8mm, center to center, and is filled with Component A00018.

Component Ref #:	A00018	Component Type:	Area - Pattern	Color Token:	Cyan
Description:	Cyan Bog, Marsh Fill				
Parameters:	AP-12, see Annex I				

Component Ref #:	P00167	Component Type:	Point - Simple	Color Token:	Cyan
Description:	Cyan 0.25mm diameter filled circle				
Parameters:	Diameter: 0.25mm				
Note:	The component is a circle and is filled with the solid color.				

**Symbol Rules**

Reference #: Description: Criteria:  
**PS-04312 Marsh / all (area)** All

**Label Rules**

Label Placement Rules (see Annex J): LP-0050, LP-3506, LP-9999

Reference #: Description:

**PL-04312\_1 Marsh / all (area)**

Criteria:

N/A

Label String: [Name]

Characteristics: 37  
 37 (Cyan, Condensed, Italic, 7-16 pt, Upper case)

Symbol Samples



**Memorial Monument (AL130)**

**Memorial Monument / non-obstruction (point)**



Symbol Graphic

Symbol Placement Instructions: Origin: Center of symbol  
 Symbol Type: Simple

Component Ref #: P00136      Component Type: Point - Shape      Color Token: Black  
 Description: Memorial monument  
 Parameters:  
 Note: See Annex H for detailed drawing instructions.

Symbol Rules

Reference #: PS-04087      Description: Memorial Monument / non-obstruction (point)      Criteria: Height Above Surface Level [HGT] < 46

Label Rules

Label Placement Rules (see Annex J): LP-3505, LP-9999

Reference #: PL-04087\_1      Description: Memorial Monument / non-obstruction (point)      Criteria: N/A

Label String: [Name]  
 Characteristics: 1  
 1 (Black, Condensed, 6 pt, Mixed case)

Symbol Samples



District of Columbia War Memorial

**Military Installation (SU001)**

Generalization Rules (see Annex J): GA-9999

**Military Installation / all (area)**



Symbol Graphic

Symbol Placement Instructions: The symbol is applied to the geometry of the feature.  
 Symbol Type: Simple

Note: Repeating pattern is Component L00450 followed by Component P00047 centered within each gap. Component L00455 is centered on Component L00450.

Component Ref #: L00450      Component Type: Line - Styled      Color Token: Black  
 Description: Black 0.15mm Dashed line (0.15mm wt, 3.0mm dash, 2.0mm gap)  
 Parameters:

Line Weight: 0.15mm      Dash Length: 3.0mm      Dash Spacing: 2.0mm

Component Ref #: L00455      Component Type: Line - Simple      Color Token: Black-42  
 Description: Black-42 1.0mm Screened Line  
[Parameters:](#)  
 Line Weight: 1.0mm  
 Screen Angle: 60 degrees  
 Screen Percent: 42%

Component Ref #: P00047      Component Type: Point - Simple      Color Token: Black  
 Description: Black 0.25mm diameter filled circle  
[Parameters:](#)  
 Diameter: 0.25mm  
 Note: The component is a circle and is filled with the solid color.

**Symbol Rules**

Reference #: Description: Criteria:  
**PS-04324** Military Installation / all (area) All

**Label Rules**

Label Placement Rules (see Annex J): LP-0050, LP-3506, LP-4813, LP-9950, LP-9999

Reference #: Description: Criteria:  
**PL-04324\_1** Military Installation / intact (area) Condition of Facility [FUN] = (Fully Functional [6], Unknown [0])

Label String: [Name] "Military Installation"  
 Characteristics: 1, 1  
 1 (Black, Condensed, 6 pt, Mixed case)

**PL-04324\_2** Military Installation / not intact (area) Condition of Facility [FUN] = (Abandoned [2], Damaged [13], Destroyed [3], Dismantled [4], Under Construction [1])

Label String: [Name] "Military Installation" "["[Condition of Facility]""]  
 Characteristics: 1, 1, 22, 22, 22  
 1 (Black, Condensed, 6 pt, Mixed case)  
 22 (Black, Condensed, 6 pt, Lower case)

**Symbol Samples**



MILITARY INSTALLATION



MILITARY INSTALLATION (destroyed)

**Military Installation / intact (point)**

Symbol Placement Instructions: Origin: Center of symbol  
 Symbol Type: Simple



Symbol Graphic

Component Ref #: P00006      Component Type: Point - Simple      Color Token: Black  
 Description: Black filled square with all sides 0.8mm  
[Parameters:](#)  
 Length: 0.8mm  
 Note: The component is a square and is filled with the solid color.

**Symbol Rules**

Reference #: Description: Criteria:  
**PS-04325** Military Installation / intact (point) Condition of Facility [FUN] = (Fully Functional [6], Unknown [0])

**Label Rules**

Label Placement Rules (see Annex J): LP-3505, LP-4813, LP-9999

Reference #: Description: Criteria:

PL-04325\_1 Military Installation / intact (point) N/A

Label String: [Name] "Military installation"  
 Characteristics: 1, 1  
 1 (Black, Condensed, 6 pt, Mixed case)

Symbol Samples



Military Installation / not intact (point)

Symbol Placement Instructions: Origin: Center of symbol  
 Symbol Type: Simple



Symbol Graphic

Component Ref #: P00173 Component Type: Point - Shape Color Token: Black/Black-12  
 Description: Not intact square 0.8mm  
 Parameters:  
 Note: See Annex H for detailed drawing instructions.

Symbol Rules

Reference #:	Description:	Criteria:
PS-04913	Military Installation / not intact (point)	Condition of Facility [FUN] = (Abandoned [2], Damaged [13], Destroyed [3], Dismantled [4], Under Construction [1])

Label Rules

Label Placement Rules (see Annex J): LP-3505, LP-4813, LP-9999

Reference #:	Description:	Criteria:
PL-04913_1	Military Installation / not intact (point)	N/A

Label String: [Name] "Military installation"  
 Characteristics: 1, 1  
 1 (Black, Condensed, 6 pt, Mixed case)

Symbol Samples

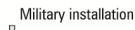

Mineral Pile (AM040)

Generalization Rules (see Annex J): GA-9999, GC-9983

Mineral Pile / non-obstruction (area)

Symbol Placement Instructions: The symbol is applied to the geometry of the feature.  
 Symbol Type: Simple



Symbol Graphic

Component Ref #: L00210      Component Type: Line - Styled      Color Token: Black  
 Description: Black 0.1mm Dashed line (0.1mm wt, 1.0mm dash, 0.5mm gap)  
Parameters:  
 Line Weight: 0.1mm      Dash Length: 1.0mm      Dash Spacing: 0.5mm

**Symbol Rules**

Reference #: Description: Criteria:  
**PS-04109 Mineral Pile / non-obstruction (area)**      Height Above Surface Level [HGT] < 46

**Label Rules**

Label Placement Rules (see Annex J): LP-3506, LP-9999

Reference #: Description: Criteria:  
**PL-04109\_1 Mineral Pile / non-obstruction / known (area)**      Product [PPO] = (Coal [18], Coke [21], Gravel [53], Metal [69], Salt [95], Sand [96], Stone [110])

Label String: [Product] "pile"  
 Characteristics: 1, 22  
 1 (Black, Condensed, 6 pt, Mixed case)  
 22 (Black, Condensed, 6 pt, Lower case)

**PL-04109\_2 Mineral Pile / non-obstruction / unknown (area)**      Product [PPO] = (Multiple [996], Other [999], Unkown [0])

Label String: "Mineral pile"  
 Characteristics: 1  
 1 (Black, Condensed, 6 pt, Mixed case)

**Symbol Samples**

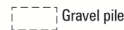

**Mineral Pile / non-obstruction (point)**



Symbol Graphic

Symbol Placement Instructions: Origin: Center of symbol  
 Symbol Type: Simple

Component Ref #: P00010      Component Type: Point - Shape      Color Token: Black  
 Description: Located object  
Parameters:  
 Note: See Annex H for detailed drawing instructions.

**Symbol Rules**

Reference #: Description: Criteria:  
**PS-04110 Mineral Pile / non-obstruction (point)**      Height Above Surface Level [HGT] < 46

**Label Rules**

Label Placement Rules (see Annex J): LP-3505, LP-9999

Reference #: Description: Criteria:  
**PL-04110\_1 Mineral Pile / non-obstruction / known (point)**      Product [PPO] = (Coal [18], Coke [21], Gravel [53], Metal [69], Salt [95], Sand [96], Stone [110])

Label String: [Product] "pile"  
 Characteristics: 1, 22  
 1 (Black, Condensed, 6 pt, Mixed case)  
 22 (Black, Condensed, 6 pt, Lower case)

PL-04110\_2 Mineral Pile / non-obstruction / unknown (point)

Product [PPO] = (Multiple [996], Other [999], Unkown [0])

Label String: "Mineral pile"  
 Characteristics: 1  
 1 (Black, Condensed, 6 pt, Mixed case)

Symbol Samples

⦿ Mineral pile

⦿ Coal pile

## Mooring Mast (AQ110)

### Mooring Mast / non-obstruction (point)



Symbol Graphic

Symbol Placement Instructions: Origin: Center of open circle

Symbol Type: Simple

Component Ref #:	P00198	Component Type:	Point - Shape	Color Token:	Black
Description:	Mooring mast				
<a href="#">Parameters:</a>					
Note:	See Annex H for detailed drawing instructions.				

#### Symbol Rules

Reference #:	Description:	Criteria:
PS-04139	Mooring Mast / non-obstruction (point)	Height Above Surface Level [HGT] < 46

Symbol Samples

⦿

## Moraine (BJ020)

Generalization Rules (see Annex J): GA-9999

### Moraine / all (area)



Symbol Graphic

Symbol Placement Instructions: The symbol is applied to the geometry of the feature.

Symbol Type: Simple

Component Ref #:	A00036	Component Type:	Area - Pattern	Color Token:	Dk-Brown1815
Description:	Dk-Brown1815 Gravel Fill				
<a href="#">Parameters:</a>					
Area Pattern:	AP-99, see Annex I				

#### Symbol Rules

Reference #:	Description:	Criteria:
PS-04227	Moraine / all (area)	All



Symbol Samples

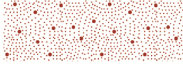

**Mountain Pass (DB150)**

**Mountain Pass / all (point)**



Symbol Graphic

Symbol Placement Instructions: Origin: Center of symbol

Symbol Type: Simple

Note: The symbol shall be aligned along the associated transportation feature, if present. Otherwise, the symbol shall be aligned so that the "open" ends are towards the lower elevations.

Component Ref #:	P00029	Component Type:	Point - Shape	Color Token:	Black
Description:	Mountain pass				
Parameters:					
Note:	See Annex H for detailed drawing instructions.				

Symbol Rules

Reference #:	Description:	Criteria:
PS-04255	Mountain Pass / all (point)	All

Label Rules

Label Placement Rules (see Annex J): LP-3505, LP-9999

Reference #:	Description:	Criteria:
PL-04255_1	Mountain Pass / all (point)	N/A

- Label String: [Name]  
[Highest Elevation]
- Characteristics: 1  
22  
1 (Black, Condensed, 6 pt, Mixed case)  
22 (Black, Condensed, 6 pt, Lower case)

Symbol Samples



**Named Location (ZD040)**

**Named Location / all (point)**



Symbol Graphic

Symbol Placement Instructions: Text label only. No graphic parameters

Symbol Type: Simple

Symbol Rules

Reference #:	Description:	Criteria:
--------------	--------------	-----------

PS-04323 Named Location / all (point) All

Label Rules

Label Placement Rules (see Annex J): LP-3505, LP-9999

Reference #:	Description:	Criteria:
PL-04323_1	Named Location / other (point)	Apply to all named locations except for populated places.

Label String: [Name]  
 Characteristics: 45  
 45 (Black, Light Condensed, 6-16 pt, Upper case)

PL-04323_2	Named Location / populated place (point)	Apply to populated place named locations.
------------	--	---

Label String: [Name]  
 Characteristics: 42  
 42 (Black, Condensed, 8 pt, Mixed case)

Symbol Samples

BADLANDS

Georgetown

Natural Pool (BH170)

Natural Pool / perennial (point)



Symbol Graphic

Symbol Placement Instructions: Origin: Center of solid circle

Symbol Type: Simple

Note: Tail of symbol is oriented downstream.

Component Ref #:	P00026	Component Type:	Point - Shape	Color Token:	Cyan
Description:	Natural pool perennial				
Parameters:					
Note:	See Annex H for detailed drawing instructions.				

Symbol Rules

Reference #:	Description:	Criteria:
PS-04210	Natural Pool / perennial (point)	Hydrologic Persistence [HYP] = Perennial [1]

Label Rules

Label Placement Rules (see Annex J): LP-3505, LP-9999

Reference #:	Description:	Criteria:
PL-04210_1	Natural Pool / perennial (point)	N/A

Label String: [Name]  
 Characteristics: 16  
 16 (Cyan, Condensed, Italic, 6 pt, Mixed case)

Symbol Samples



Natural Pool / intermittent, dry (point)



Symbol Graphic

Symbol Placement Instructions: Origin: Center of open circle

Symbol Type: Simple

Note: Tail of symbol is oriented downstream.

Component Ref #:	P00032	Component Type:	Point - Shape	Color Token:	Cyan
Description:	Natural pool intermittent				
<a href="#">Parameters:</a>					
Note:	See Annex H for detailed drawing instructions.				

### Symbol Rules

Reference #:	Description:	Criteria:
PS-04211	Natural Pool / intermittent, dry (point)	Hydrologic Persistence [HYP] = (Dry [4], Intermittent [2], Unknown [0])

### Label Rules

Label Placement Rules (see Annex J): LP-3505, LP-9999

Reference #:	Description:	Criteria:
PL-04211_1	Natural Pool / intermittent, dry (point)	N/A

Label String: [Name]  
 Characteristics: 16  
 16 (Cyan, Condensed, Italic, 6 pt, Mixed case)

### Symbol Samples



## Oasis (EC020)

Generalization Rules (see Annex J): GA-9999, GC-9999

### Oasis / all (area)



Symbol Graphic

Symbol Placement Instructions: The symbol is applied to the geometry of the feature.

Symbol Type: Simple

Component Ref #:	L00021	Component Type:	Line - Simple	Color Token:	Green362
Description:	Green362 0.2mm Solid Line				
<a href="#">Parameters:</a>					
Line Weight:	0.2mm				

### Symbol Rules

Reference #:	Description:	Criteria:
PS-04310	Oasis / all (area)	All

### Label Rules

Label Placement Rules (see Annex J): LP-0050, LP-3506, LP-4813, LP-9999

Reference #:	Description:	Criteria:
PL-04310_1	Oasis / all (area)	N/A

Label String: [Name] "Oasis"  
 Characteristics: 3, 3  
 3 (Black, Condensed, 6-16 pt, Mixed case)

Symbol Samples



Oasis

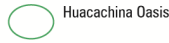

Huacachina Oasis

Oasis / all (point)



Symbol Graphic

Symbol Placement Instructions: Origin: Center of symbol  
 Symbol Type: Simple

Component Ref #: P00260      Component Type: Point - Shape      Color Token: Green362  
 Description: Oasis  
Parameters:  
 Note: See Annex H for detailed drawing instructions.

Symbol Rules

Reference #:	Description:	Criteria:
PS-04654	Oasis / all (point)	All

Label Rules

Label Placement Rules (see Annex J): LP-3505, LP-9999

Reference #:	Description:	Criteria:
PL-04654_1	Oasis / all (point)	N/A

Label String: [Name]  
 Characteristics: 1  
 1 (Black, Condensed, 6 pt, Mixed case)

Symbol Samples



Quara Oasis

Offshore Platform (BD110)

Offshore Platform / non-obstruction (point)



Symbol Graphic

Symbol Placement Instructions: Origin: Center of symbol  
 Symbol Type: Simple

Component Ref #: P00163      Component Type: Point - Shape      Color Token: Black  
 Description: Offshore construction point  
Parameters:  
 Note: See Annex H for detailed drawing instructions.

Symbol Rules

Reference #:	Description:	Criteria:
PS-04201	Offshore Platform / non-obstruction (point)	Height Above Surface Level [HGT] < 46

Label Rules

Label Placement Rules (see Annex J): LP-3505

Reference #: Description: Criteria:  
**PL-04201\_1** **Offshore Platform / non-obstruction (point)** N/A

Label String: "Platform"  
 Characteristics: 1  
 1 (Black, Condensed, 6 pt, Mixed case)

Symbol Samples

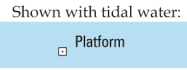

Orchard (EA040)

Generalization Rules (see Annex J): GA-9999

Orchard / all (area)

Symbol Placement Instructions: The symbol is applied to the geometry of the feature.  
 Symbol Type: Simple



Symbol Graphic

Component Ref #: A00028 Component Type: Area - Pattern Color Token: Green362  
 Description: Green362 Orchard / Plantation Fill  
 Parameters:  
 Area Pattern: AP-74, see Annex I

Symbol Rules

Reference #: Description: Criteria:  
**PS-04305** **Orchard / all (area)** All

Label Rules

Label Placement Rules (see Annex J): LP-3506, LP-4813, LP-9999

Reference #: Description: Criteria:  
**PL-04305\_1** **Orchard / crop known (area)** Crop Species [CSP] = (Banana [41], Fruit Tree [15], Nut [113], Palm [157], Rubber [29])  
 Label String: [Name] [Crop Species]  
 Characteristics: 1, 1  
 1 (Black, Condensed, 6 pt, Mixed case)  
**PL-04305\_2** **Orchard / crop unknown (area)** Crop Species [CSP] = ( Other [999], Unknown [0])  
 Label String: [Name]  
 Characteristics: 1  
 1 (Black, Condensed, 6 pt, Mixed case)

Symbol Samples



Park (AK120)

Generalization Rules (see Annex J): GA-9999, GC-9999

**Park / all (area)**



Symbol Graphic

Symbol Placement Instructions: The symbol is applied to the geometry of the feature.

Symbol Type: Complex

Note: Component L00368 is applied to the perimeter and is filled with Component A00101.

Component Ref #:	A00101	Component Type:	Area - Fill	Color Token:	Green362-12
Description:	Green362-12 area fill				
Parameters:					
Screen Angle:	45 degrees				
Screen Percent:	12%				

Component Ref #:	L00368	Component Type:	Line - Styled	Color Token:	Green362
Description:	Green362 0.15mm Dashed Line (0.15mm wt, 1.0mm dash, 0.5mm gap)				
Parameters:					
Line Weight:	0.15mm	Dash Length:	1.0mm	Dash Spacing:	0.5mm

**Symbol Rules**

Reference #:	Description:	Criteria:
PS-04059	Park / all (area)	All

**Label Rules**

Label Placement Rules (see Annex J): LP-0050, LP-3506, LP-4813, LP-9999

Reference #:	Description:	Criteria:
PL-04059_1	Park / all (area)	N/A

Label String: [Name] "Park"  
 Characteristics: 3, 3  
 3 (Black, Condensed, 6-16 pt, Mixed case)

**Symbol Samples**



**Park / all (point)**



Symbol Graphic

Symbol Placement Instructions: Origin: Center of symbol

Symbol Type: Simple

Component Ref #:	P00146	Component Type:	Point - Simple	Color Token:	Green362
Description:	Green362 filled square with all sides 0.8mm				
Parameters:					
Length:	0.8mm				
Note:	The component is a square and is filled with the solid color.				

**Symbol Rules**

Reference #:	Description:	Criteria:
PS-04594	Park / all (point)	All

**Label Rules**

Label Placement Rules (see Annex J): LP-3505, LP-4813, LP-9999

Reference #:	Description:	Criteria:

PL-04594\_1 Park / all (point)

N/A

Label String: [Name] "Park"  
 Characteristics: 1, 1  
 1 (Black, Condensed, 6 pt, Mixed case)

Symbol Samples



Particle Accelerator (AL140)

Generalization Rules (see Annex J): GA-9999, GC-9989

Particle Accelerator / all (area)



Symbol Graphic

Symbol Placement Instructions: The symbol is applied to the geometry of the feature.  
 Symbol Type: Simple

Component Ref #:	L00210	Component Type:	Line - Styled	Color Token:	Black
Description:	Black 0.1mm Dashed line (0.1mm wt, 1.0mm dash, 0.5mm gap)				
Parameters:					
Line Weight:	0.1mm	Dash Length:	1.0mm	Dash Spacing:	0.5mm

Symbol Rules

Reference #:	Description:	Criteria:
PS-04090	Particle Accelerator / all (area)	All

Label Rules

Label Placement Rules (see Annex J): LP-3505, LP-4813, LP-9999

Reference #:	Description:	Criteria:
PL-04090_1	Particle Accelerator / all (area)	N/A

Label String: [Name] "Particle accelerator"  
 Characteristics: 1, 1  
 1 (Black, Condensed, 6 pt, Mixed case)

Symbol Samples



Particle Accelerator / all (line)



Symbol Graphic

Symbol Placement Instructions: The symbol is applied to the geometry of the feature.  
 Symbol Type: Simple

Component Ref #:	L00014	Component Type:	Line - Simple	Color Token:	Black
Description:	Black 0.5mm Solid Line				
Parameters:					

Line Weight: 0.5mm

Symbol Rules

Reference #: Description: Criteria:  
**PS-04597 Particle Accelerator / all (line)** All

Label Rules

Label Placement Rules (see Annex J): LP-3630, LP-4813, LP-9999

Reference #: Description: Criteria:  
**PL-04597\_1 Particle Accelerator / all (line)** N/A

Label String: [Name] "Particle accelerator"  
 Characteristics: 1, 1  
 1 (Black, Condensed, 6 pt, Mixed case)

Symbol Samples

Particle accelerator

Stanford Linear Collider Particle Accelerator

**Penstock (BH110)**

Generalization Rules (see Annex J): GA-9999

**Penstock / on surface (line)**



Symbol Graphic

Symbol Placement Instructions: The symbol is applied to the geometry of the feature.

Symbol Type: Simple

Component Ref #: L00016      Component Type: Line - Simple      Color Token: Cyan  
 Description: Cyan 0.3mm Solid Line  
Parameters:  
 Line Weight: 0.3mm

Symbol Rules

Reference #: Description: Criteria:  
**PS-04194 Penstock / on surface (line)** Vertical Relative Location [LOC] = (On Surface [44], Unknown [0])

Label Rules

Label Placement Rules (see Annex J): LP-3630

Reference #: Description: Criteria:  
**PL-04194\_1 Penstock / on surface (line)** N/A

Label String: "Penstock"  
 Characteristics: 16  
 16 (Cyan, Condensed, Italic, 6 pt, Mixed case)

Symbol Samples

Penstock

**Penstock / below surface (line)**





Symbol Placement Instructions: The symbol is applied to the geometry of the feature.  
 Symbol Type: Simple

Symbol Graphic

Component Ref #:	L00235	Component Type:	Line - Styled	Color Token:	Cyan
Description:	Cyan 0.3mm Dashed Line (0.3mm wt, 1.0mm dash, 0.5mm gap)				
<u>Parameters:</u>					
Line Weight:	0.3mm	Dash Length:	1.0mm	Dash Spacing:	0.5mm

**Symbol Rules**

Reference #:	Description:	Criteria:
PS-04195	Penstock / below surface (line)	Vertical Relative Location [LOC] = Below Ground Surface [40]

**Label Rules**

Label Placement Rules (see Annex J):	LP-3630	
Reference #:	Description:	Criteria:
PL-04195_1	Penstock / below surface (line)	N/A
Label String:	"Penstock"	
Characteristics:	16 16 (Cyan, Condensed, Italic, 6 pt, Mixed case)	

**Symbol Samples**



**Penstock / above surface (line)**



Symbol Placement Instructions: The symbol is applied to the geometry of the feature.  
 Symbol Type: Complex

Symbol Graphic

Note: Apex of Component P00208 is fixed at the start and end of Component L00016 with each "V" facing away. The 90 degree angle of the "V" is bisected equally by Component L00016.

Component Ref #:	L00016	Component Type:	Line - Simple	Color Token:	Cyan
Description:	Cyan 0.3mm Solid Line				
<u>Parameters:</u>					
Line Weight:	0.3mm				

Component Ref #:	P00208	Component Type:	Point - Shape	Color Token:	Cyan
Description:	Aqueduct/penstock/water race "V"				
<u>Parameters:</u>					
Note:	See Annex H for detailed drawing instructions.				

**Symbol Rules**

Reference #:	Description:	Criteria:
PS-04196	Penstock / above surface (line)	Vertical Relative Location [LOC] = Above Surface [45]

**Label Rules**

Label Placement Rules (see Annex J):	LP-3630	
Reference #:	Description:	Criteria:
PL-04196_1	Penstock / above surface (line)	N/A
Label String:	"Penstock"	
Characteristics:	16	

Symbol Samples



Pipeline (AQ113)

Generalization Rules (see Annex J): GA-9999

Pipeline / on surface / not water (line)

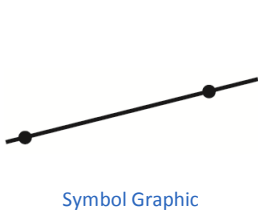

**Symbol Placement Instructions:** The symbol is applied to the geometry of the feature.  
**Symbol Type:** Complex  
**Repeating Point and Interval:** Component P00193 has an initial offset of 5.0mm; after that 10.0mm.  
**Note:** Component P00193 is centered along Component L00009.

Component Ref #:	L00009	Component Type:	Line - Simple	Color Token:	Black
Description:	Black 0.2mm Solid Line				
<u>Parameters:</u>					
Line Weight:	0.2mm				
Component Ref #:	P00193	Component Type:	Point - Simple	Color Token:	Black
Description:	Black 0.7mm diameter filled circle				
<u>Parameters:</u>					
Diameter:	0.7mm				
Note:	The component is a circle and is filled with the solid color.				

Symbol Rules

Reference #:	Description:	Criteria:
PS-04329	Pipeline / on surface / not water (line)	Vertical Relative Location [LOC] = (On Surface [44], Unknown [0])
	AND	Product [PPO] = (Chemical [16], Gas [45], Petrol [46], Oil [75], Other [999], Sewage [101], Unknown [0])

Label Rules

Label Placement Rules (see Annex J): LP-3630, LP-9950, LP-9999

Reference #:	Description:	Criteria:
PL-04329_1	Pipeline / on surface / not water / intact (line)	Condition of Facility [FUN] = (Fully Functional [6], Unknown [0])
	Label String: [Product]	
	Characteristics: 1 1 (Black, Condensed, 6 pt, Mixed case)	
PL-04329_2	Pipeline / on surface / not water / not intact (line)	Condition of Facility [FUN] = (Abandoned [2], Damaged [13], Destroyed [3], Dismantled [4], Under Construction [1])
	Label String: [Product] "["[Condition of Facility]"	
	Characteristics: 1, 22, 22, 22 1 (Black, Condensed, 6 pt, Mixed case) 22 (Black, Condensed, 6 pt, Lower case)	

Symbol Samples

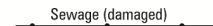

Pipeline / on surface / water (line)

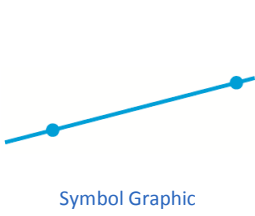

**Symbol Placement Instructions:** The symbol is applied to the geometry of the feature.  
**Symbol Type:** Complex  
**Repeating Point and Interval:** Component P00125 has an initial offset of 5.0mm; after that 10.0mm.  
**Note:** Component P00125 is centered along Component L00015.

<b>Component Ref #:</b>	L00015	<b>Component Type:</b>	Line - Simple	<b>Color Token:</b>	Cyan
<b>Description:</b>	Cyan 0.2mm Solid Line				
<b>Parameters:</b>	<a href="#">Line Weight:</a> 0.2mm				

<b>Component Ref #:</b>	P00125	<b>Component Type:</b>	Point - Simple	<b>Color Token:</b>	Cyan
<b>Description:</b>	Cyan 0.7mm diameter filled circle				
<b>Parameters:</b>	<a href="#">Diameter:</a> 0.7mm				
<b>Note:</b>	The component is a circle and is filled with the solid color.				

**Symbol Rules**

<b>Reference #:</b>	<b>Description:</b>	<b>Criteria:</b>
PS-04330	Pipeline / on surface / water (line)	Vertical Relative Location [LOC] = (On Surface [44], Unknown [0]) AND Product [PPO] = Water [122]

**Label Rules**

<b>Label Placement Rules (see Annex J):</b> LP-3630, LP-9950, LP-9999		
<b>Reference #:</b>	<b>Description:</b>	<b>Criteria:</b>
PL-04330_1	Pipeline / on surface / water / not intact (line)	Condition of Facility [FUN] = (Abandoned [2], Damaged [13], Destroyed [3], Dismantled [4], Under Construction [1])
	<b>Label String:</b> "[Condition of Facility]"	
	<b>Characteristics:</b> 93, 93, 93 93 (Cyan, Condensed, 6 pt, Lower case)	

**Symbol Samples**



**Pipeline / below surface / not water (line)**

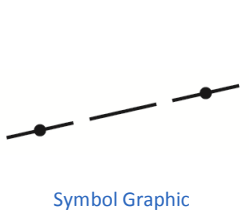

**Symbol Placement Instructions:** The symbol is applied to the geometry of the feature.  
**Symbol Type:** Complex  
**Repeating Point and Interval:** Component P00193 is centered on the first dash then every other dash of Component L00404.  
**Note:** Component P00193 is centered along Component L00404.

<b>Component Ref #:</b>	L00404	<b>Component Type:</b>	Line - Styled	<b>Color Token:</b>	Black
<b>Description:</b>	Black 0.2mm Dashed Line (0.2mm wt, 4.0mm dash, 1.0mm gap)				
<b>Parameters:</b>	<a href="#">Line Weight:</a> 0.2mm	<a href="#">Dash Length:</a> 4.0mm	<a href="#">Dash Spacing:</a> 1.0mm		

<b>Component Ref #:</b>	P00193	<b>Component Type:</b>	Point - Simple	<b>Color Token:</b>	Black
<b>Description:</b>	Black 0.7mm diameter filled circle				
<b>Parameters:</b>	<a href="#">Diameter:</a> 0.7mm				
<b>Note:</b>	The component is a circle and is filled with the solid color.				

**Symbol Rules**

<b>Reference #:</b>	<b>Description:</b>	<b>Criteria:</b>
---------------------	---------------------	------------------

**PS-04331 Pipeline / below surface / not water (line)** Vertical Relative Location [LOC] = (Above Waterbody Bottom [46], Below Waterbody Bottom [23], Below Ground Surface [40], On Waterbody Bottom [17])  
 AND Product [PPO] = (Chemical [16], Gas [45], Petrol [46], Oil [75], Other [999], Sewage [101], Unknown [0])

**Label Rules**

Label Placement Rules (see Annex J): LP-3630, LP-9950, LP-9999

Reference #: Description: Criteria:  
**PL-04331\_1 Pipeline / below surface / not water / intact (line)** Condition of Facility [FUN] = (Fully Functional [6], Unknown [0])

Label String: [Product]  
 Characteristics: 1  
 1 (Black, Condensed, 6 pt, Mixed case)

**PL-04331\_2 Pipeline / below surface / not water / not intact (line)** Condition of Facility [FUN] = (Abandoned [2], Damaged [13], Destroyed [3], Dismantled [4], Under Construction [1])

Label String: [Product] "["[Condition of Facility]""]  
 Characteristics: 1, 22, 22, 22  
 1 (Black, Condensed, 6 pt, Mixed case)  
 22 (Black, Condensed, 6 pt, Lower case)

**Symbol Samples**



**Pipeline / below surface / water (line)**

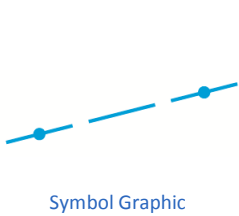

Symbol Placement Instructions: The symbol is applied to the geometry of the feature.  
 Symbol Type: Complex  
 Repeating Point and Interval: Component P00125 is centered on the first dash then every other dash of Component L00405.  
 Note: Component P00125 is centered along Component L00405.

Component Ref #:	L00405	Component Type:	Line - Styled	Color Token:	Cyan
Description:	Cyan 0.2mm Dashed Line (0.2mm wt, 4.0mm dash, 1.0mm gap)				
Parameters:					
Line Weight:	0.2mm	Dash Length:	4.0mm	Dash Spacing:	1.0mm

Component Ref #:	P00125	Component Type:	Point - Simple	Color Token:	Cyan
Description:	Cyan 0.7mm diameter filled circle				
Parameters:					
Diameter:	0.7mm				
Note:	The component is a circle and is filled with the solid color.				

**Symbol Rules**

Reference #: Description: Criteria:  
**PS-04332 Pipeline / below surface / water (line)** Vertical Relative Location [LOC] = (Above Waterbody Bottom [46], Below Waterbody Bottom [23], Below Ground Surface [40], On Waterbody Bottom [17])  
 AND Product [PPO] = Water [122]

**Label Rules**

Label Placement Rules (see Annex J): LP-3630, LP-9950, LP-9999

Reference #: Description: Criteria:  
**PL-04332\_1 Pipeline / below surface / water / not intact (line)** Condition of Facility [FUN] = (Abandoned [2], Damaged [13], Destroyed [3], Dismantled [4], Under Construction [1])

Label String: "["[Condition of Facility]""]  
 Characteristics: 93, 93, 93  
 93 (Cyan, Condensed, 6 pt, Lower case)

**Symbol Samples**



(construction)

**Pipeline / above surface / not water (line)**

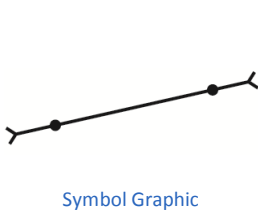

**Symbol Placement Instructions:** The symbol is applied to the geometry of the feature.

**Symbol Type:** Complex

**Repeating Point and Interval:** Component P00193 has an initial offset of 5.0mm; after that 10.0mm.

**Note:** Apex of Component P00045 is fixed at the start and end of Component L00009 with each "V" facing away. The 90 degree angle of the "V" is bisected equally by Component L00009. Component P00193 is centered along Component L00009.

<b>Component Ref #:</b>	L00009	<b>Component Type:</b>	Line - Simple	<b>Color Token:</b>	Black
<b>Description:</b>	Black 0.2mm Solid Line				
<b>Parameters:</b>	Line Weight: 0.2mm				
<b>Component Ref #:</b>	P00193	<b>Component Type:</b>	Point - Simple	<b>Color Token:</b>	Black
<b>Description:</b>	Black 0.7mm diameter filled circle				
<b>Parameters:</b>	Diameter: 0.7mm				
<b>Note:</b>	The component is a circle and is filled with the solid color.				
<b>Component Ref #:</b>	P00045	<b>Component Type:</b>	Point - Shape	<b>Color Token:</b>	Black
<b>Description:</b>	Pipeline elevated "V"				
<b>Parameters:</b>	Note: See Annex H for detailed drawing instructions.				

**Symbol Rules**

<b>Reference #:</b>	<b>Description:</b>	<b>Criteria:</b>
PS-04333	Pipeline / above surface / not water (line)	Vertical Relative Location [LOC] = Above Surface [45]
	AND	Product [PPO] = (Chemical [16], Gas [45], Petrol [46], Oil [75], Other [999], Sewage [101], Unknown [0])

**Label Rules**

Label Placement Rules (see Annex J): LP-3630, LP-9950, LP-9999

<b>Reference #:</b>	<b>Description:</b>	<b>Criteria:</b>
PL-04333_1	Pipeline / above surface / not water / intact (line)	Condition of Facility [FUN] = (Fully Functional [6], Unknown [0])
	Label String: [Product]	
	Characteristics: 1 1 (Black, Condensed, 6 pt, Mixed case)	
PL-04333_2	Pipeline / above surface / not water / not intact (line)	Condition of Facility [FUN] = (Abandoned [2], Damaged [13], Destroyed [3], Dismantled [4], Under Construction [1])
	Label String: [Product] "["[Condition of Facility]"	
	Characteristics: 1, 22, 22, 22 1 (Black, Condensed, 6 pt, Mixed case) 22 (Black, Condensed, 6 pt, Lower case)	

**Symbol Samples**

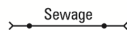

**Pipeline / above surface / water (line)**

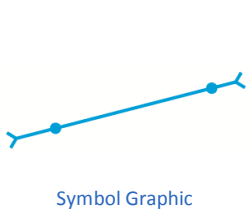

**Symbol Placement Instructions:** The symbol is applied to the geometry of the feature.

**Symbol Type:** Complex

**Repeating Point and Interval:** Component P00125 has an initial offset of 5.0mm; after that 10.0mm.

**Note:** Apex of Component P00058 is fixed at the start and end of Component L00015 with each "V" facing away. The 90 degree angle of the "V" is bisected equally by Component L00015. Component P00125 is centered along Component L00015.

<b>Component Ref #:</b>	L00015	<b>Component Type:</b>	Line - Simple	<b>Color Token:</b>	Cyan
<b>Description:</b>	Cyan 0.2mm Solid Line				
<b>Parameters:</b>	<a href="#">Line Weight:</a> 0.2mm				
<b>Component Ref #:</b>	P00125	<b>Component Type:</b>	Point - Simple	<b>Color Token:</b>	Cyan
<b>Description:</b>	Cyan 0.7mm diameter filled circle				
<b>Parameters:</b>	<a href="#">Diameter:</a> 0.7mm				
<b>Note:</b>	The component is a circle and is filled with the solid color.				
<b>Component Ref #:</b>	P00058	<b>Component Type:</b>	Point - Shape	<b>Color Token:</b>	Cyan
<b>Description:</b>	Pipeline water elevated "V"				
<b>Parameters:</b>	<a href="#">Note:</a> See Annex H for detailed drawing instructions.				

### Symbol Rules

<b>Reference #:</b>	<b>Description:</b>	<b>Criteria:</b>
<b>PS-04334</b>	<b>Pipeline / above surface / water (line)</b>	Vertical Relative Location [LOC] = Above Surface [45]
	AND	Product [PPO] = Water [122]

### Label Rules

<b>Label Placement Rules (see Annex J):</b>	LP-3630, LP-9950, LP-9999	
<b>Reference #:</b>	<b>Description:</b>	<b>Criteria:</b>
<b>PL-04334_1</b>	<b>Pipeline / above surface / water / not intact (line)</b>	Condition of Facility [FUN] = (Abandoned [2], Damaged [13], Destroyed [3], Dismantled [4], Under Construction [1])
	<b>Label String:</b> "[Condition of Facility]"	
	<b>Characteristics:</b> 93, 93, 93 93 (Cyan, Condensed, 6 pt, Lower case)	

### Symbol Samples



## Point of Change (No Code)

### Point of Change / all (point)

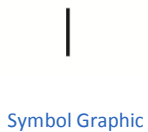

**Symbol Placement Instructions:** The symbol is applied to the geometry of the feature.

**Symbol Type:** Simple

**Note:** The symbol is placed perpendicular to and on the upper side (north) of the associated feature symbol. It is used only where necessary to denote a non-symbolized change in information or classification.

<b>Component Ref #:</b>	P00153	<b>Component Type:</b>	Point - Simple	<b>Color Token:</b>	Black
<b>Description:</b>	Black 2.0mm length line with a 0.15mm linewidth				
<b>Parameters:</b>	<a href="#">Line Weight:</a> 0.15mm				
<b>Length:</b>	2.0mm				

Symbol Rules

Reference #: **PS-04857** Description: **Point of Change / all (point)** Criteria: All

Symbol Samples

Shown with Road:  
8 LANES | 6 LANES

**Power Line (AT030)**

Generalization Rules (see Annex J): GA-9999, GC-9988

**Power Line / non-obstruction (line)**



Symbol Graphic

Symbol Placement Instructions: The symbol is applied to the geometry of the feature.

Symbol Type: Complex

Repeating Point and Interval: Component P00020 has an initial offset of 10.0mm; after that 20.0mm.

Note: Component P00020 is centered along Component L00005. Default orientation for top of component P00020 should point in a northerly direction.

Component Ref #:	L00005	Component Type:	Line - Simple	Color Token:	Blue072
Description:	Blue072 0.4mm Solid Line				
Parameters:					
Line Weight:	0.4mm				

Component Ref #:	P00020	Component Type:	Point - Shape	Color Token:	Blue072
Description:	Pylon				
Parameters:					
Note:	See Annex H for detailed drawing instructions.				

Symbol Rules

Reference #: **PS-04433** Description: **Power Line / non-obstruction (line)** Criteria: Height Above Surface Level [HGT] < 46

Label Rules

Label Placement Rules (see Annex J): LP-3630, LP-9950, LP-9999

Reference #: **PL-04433\_1** Description: **Power Line / non-obstruction / not intact (line)** Criteria: Condition of Facility [FUN] = (Abandoned [2], Damaged [13], Destroyed [3], Dismantled [4], Under Construction [1])

Label String: ("["Condition of Facility"]")

Characteristics: 15  
15 (Blue072, Condensed, 6 pt, Mixed case)

Symbol Samples



**Power Line / obstruction (line)**



Symbol Placement Instructions: The symbol is applied to the geometry of the feature.  
 Symbol Type: Simple

Symbol Graphic

Component Ref #:	L00006	Component Type:	Line - Simple	Color Token:	Blue072
Description:	Blue072 0.73mm Solid Line				
<u>Parameters:</u>					
Line Weight:	0.73mm				

### Symbol Rules

Reference #:	Description:	Criteria:
PS-04474	Power Line / obstruction (line)	Height Above Surface Level [HGT] >= 46

### Label Rules

Label Placement Rules (see Annex J): LP-9991

Reference #:	Description:	Criteria:
PL-04474_1	Power Line / obstruction (line)	N/A

Label String: "Powerline"  
 [Highest Elevation]  
 "["[Height Above Surface Level]""]"

Characteristics: 15  
 46  
 95, 95, 95  
 15 (Blue072, Condensed, 6 pt, Mixed case)  
 46 (Blue072, Condensed, Bold, 6 pt, Lower case)

### Symbol Samples

Powerline  
 242  
 (72)



## Power Substation (AD030)

Generalization Rules (see Annex J): GA-9999, GC-9982

### Power Substation / all (area)



Symbol Placement Instructions: The symbol is applied to the geometry of the feature.  
 Symbol Type: Complex

Symbol Graphic

Note: Component L00210 is applied to the perimeter and Component P00138 is placed in the center.

Component Ref #:	L00210	Component Type:	Line - Styled	Color Token:	Black
Description:	Black 0.1mm Dashed line (0.1mm wt, 1.0mm dash, 0.5mm gap)				
<u>Parameters:</u>					
Line Weight:	0.1mm	Dash Length:	1.0mm	Dash Spacing:	0.5mm

Component Ref #:	P00138	Component Type:	Point - Shape	Color Token:	Black/Blue072-42
Description:	Power substation				
<u>Parameters:</u>					
Note:	See Annex H for detailed drawing instructions.				

### Symbol Rules

Reference #:	Description:	Criteria:
PS-04297	Power Substation / all (area)	All

### Label Rules



Label Placement Rules (see Annex J): LP-3506, LP-9950, LP-9999

Reference #: Description:

**PL-04297\_1** Power Substation / not intact (area)

Criteria:

Condition of Facility [FUN] = (Abandoned [2], Damaged [13], Destroyed [3], Dismantled [4], Under Construction [1])

Label String: "[Condition of Facility]"

Characteristics: 22, 22, 22  
22 (Black, Condensed, 6 pt, Lower case)

Symbol Samples

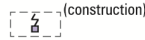

Power Substation / all (point)



Symbol Graphic

Symbol Placement Instructions: Origin: Center of open square

Symbol Type: Simple

Component Ref #:	P00138	Component Type:	Point - Shape	Color Token:	Black/Blue072-42
Description:	Power substation				
Parameters:					
Note:	See Annex H for detailed drawing instructions.				

Symbol Rules

Reference #: Description: Criteria:

**PS-04298** Power Substation / all (point) All

Label Rules

Label Placement Rules (see Annex J): LP-3505, LP-9950, LP-9999

Reference #: Description:

**PL-04298\_1** Power Substation /not intact (point)

Criteria:

Condition of Facility [FUN] = (Abandoned [2], Damaged [13], Destroyed [3], Dismantled [4], Under Construction [1])

Label String: "[Condition of Facility]"

Characteristics: 22, 22, 22  
22 (Black, Condensed, 6 pt, Lower case)

Symbol Samples



Processing Facility (AC000)

Generalization Rules (see Annex J): GA-9999

Processing Facility / all (area)



Symbol Graphic

Symbol Placement Instructions: The symbol is applied to the geometry of the feature.

Symbol Type: Simple

<b>Component Ref #:</b>	L00210	<b>Component Type:</b>	Line - Styled	<b>Color Token:</b>	Black
<b>Description:</b>	Black 0.1mm Dashed line (0.1mm wt, 1.0mm dash, 0.5mm gap)				
<b>Parameters:</b>					
<b>Line Weight:</b>	0.1mm	<b>Dash Length:</b>	1.0mm	<b>Dash Spacing:</b>	0.5mm

**Symbol Rules**

<b>Reference #:</b>	<b>Description:</b>	<b>Criteria:</b>
<b>PS-04410</b>	<b>Processing Facility / all (area)</b>	All

**Label Rules**

Label Placement Rules (see Annex J): LP-3506, LP-4813, LP-9950, LP-9999

<b>Reference #:</b>	<b>Description:</b>	<b>Criteria:</b>
<b>PL-04410_1</b>	<b>Processing Facility / intact / known (area)</b>	Condition of Facility [FUN] = (Fully Functional [6], Unknown [0])

AND Product [PPO] = (Aluminum [2], Asphalt [4], Biochemical [136], Brick [13], Cement [15], Chemical [16], Coal [18], Coke [21], Concrete [23], Copper [26], Explosive [38], Fish [39], Food [41], Gas [45], Glass [47], Gold [48], Ice [57], Iron [58], Lead [59], Lumber [63], Metal [69], Oil [75], Paper [80], Petrochemical [137], Petrol [46], Plastic [84], Radioactive Material [90], Rubber [94], Sewage [101], Silver [105], Snow [106], Steel [109], Sugar [111], Textile [114], Tobacco [117], Uranium [120], Vegetation Product [121], Water [122], Zinc [126])

**Label String:** [Name] [Product] "processing facility"  
**Characteristics:** 1, 1, 22  
 1 (Black, Condensed, 6 pt, Mixed case)  
 22 (Black, Condensed, 6 pt, Lower case)

<b>PL-04410_2</b>	<b>Processing Facility / intact / unknown (area)</b>	Condition of Facility [FUN] = (Fully Functional [6], Unknown [0])
-------------------	--	---

AND Product [PPO] = (Other [999], Unknown [0])

**Label String:** [Name] "Processing facility"  
**Characteristics:** 1, 1  
 1 (Black, Condensed, 6 pt, Mixed case)

<b>PL-04410_3</b>	<b>Processing Facility / not intact / known (area)</b>	Condition of Facility [FUN] = (Abandoned [2], Damaged [13], Destroyed [3], Dismantled [4], Under Construction [1])
-------------------	--	--

AND Product [PPO] = (Aluminum [2], Asphalt [4], Biochemical [136], Brick [13], Cement [15], Chemical [16], Coal [18], Coke [21], Concrete [23], Copper [26], Explosive [38], Fish [39], Food [41], Gas [45], Glass [47], Gold [48], Ice [57], Iron [58], Lead [59], Lumber [63], Metal [69], Oil [75], Paper [80], Petrochemical [137], Petrol [46], Plastic [84], Radioactive Material [90], Rubber [94], Sewage [101], Silver [105], Snow [106], Steel [109], Sugar [111], Textile [114], Tobacco [117], Uranium [120], Vegetation Product [121], Water [122], Zinc [126])

**Label String:** [Name] [Product] "processing facility" "["[Condition of Facility]""]"  
**Characteristics:** 1, 1, 22, 22, 22, 22  
 1 (Black, Condensed, 6 pt, Mixed case)  
 22 (Black, Condensed, 6 pt, Lower case)

<b>PL-04410_4</b>	<b>Processing Facility / not intact / unknown (area)</b>	Condition of Facility [FUN] = (Abandoned [2], Damaged [13], Destroyed [3], Dismantled [4], Under Construction [1])
-------------------	--	--

AND Product [PPO] = (Other [999], Unknown [0])

**Label String:** [Name] "Processing facility" "["[Condition of Facility]""]"  
**Characteristics:** 1, 1, 22, 22, 22  
 1 (Black, Condensed, 6 pt, Mixed case)  
 22 (Black, Condensed, 6 pt, Lower case)

**Symbol Samples**



**Processing Facility / intact (point)**

Symbol Placement Instructions: Origin: Center of symbol

Symbol Type: Simple



Symbol Graphic

**Component Ref #:** P00006      **Component Type:** Point - Simple      **Color Token:** Black  
**Description:** Black filled square with all sides 0.8mm  
Parameters:  
**Length:** 0.8mm  
**Note:** The component is a square and is filled with the solid color.

**Symbol Rules**

**Reference #:** **Description:**      **Criteria:**  
**PS-04411**      **Processing Facility / intact (point)**      Condition of Facility [FUN] = (Fully Functional [6], Unknown [0])

**Label Rules**

**Label Placement Rules (see Annex J):** LP-3505, LP-4813, LP-9999

**Reference #:** **Description:**      **Criteria:**  
**PL-04411\_1**      **Processing Facility / intact / known (point)**      Product [PPO] = (Aluminum [2], Asphalt [4], Biochemical [136], Brick [13], Cement [15], Chemical [16], Coal [18], Coke [21], Concrete [23], Copper [26], Explosive [38], Fish [39], Food [41], Gas [45], Glass [47], Gold [48], Ice [57], Iron [58], Lead [59], Lumber [63], Metal [69], Oil [75], Paper [80], Petrochemical [137], Petrol [46], Plastic [84], Radioactive Material [90], Rubber [94], Sewage [101], Silver [105], Snow [106], Steel [109], Sugar [111], Textile [114], Tobacco [117], Uranium [120], Vegetation Product [121], Water [122], Zinc [126])

**Label String:** [Name] [Product] "processing facility"  
**Characteristics:** 1, 1, 22  
 1 (Black, Condensed, 6 pt, Mixed case)  
 22 (Black, Condensed, 6 pt, Lower case)

**PL-04411\_2**      **Processing Facility / intact / unknown (point)**      Product [PPO] = (Other [999], Unknown [0])

**Label String:** [Name] "Processing facility"  
**Characteristics:** 1, 1  
 1 (Black, Condensed, 6 pt, Mixed case)

**Symbol Samples**

■ Processing facility

■ Hyperion Sewage Treatment Plant

■ Fish processing facility

**Processing Facility / not intact (point)**

Symbol Placement Instructions: Origin: Center of symbol

Symbol Type: Simple



Symbol Graphic

**Component Ref #:** P00173      **Component Type:** Point - Shape      **Color Token:** Black/Black-12  
**Description:** Not intact square 0.8mm  
Parameters:  
**Note:** See Annex H for detailed drawing instructions.

**Symbol Rules**

**Reference #:** **Description:**      **Criteria:**  
**PS-04412**      **Processing Facility / not intact (point)**      Condition of Facility [FUN] = (Abandoned [2], Damaged [13], Destroyed [3], Dismantled [4], Under Construction [1])

Label Rules

Label Placement Rules (see Annex J): LP-3505, LP-4813, LP-9999

Reference #: **PL-04412\_1** Description: **Processing Facility / not intact / known (point)**

Label String: [Name] [Product] "processing facility"  
 Characteristics: 1, 1, 22  
 1 (Black, Condensed, 6 pt, Mixed case)  
 22 (Black, Condensed, 6 pt, Lower case)

Criteria:  
 Product [PPO] = (Aluminum [2], Asphalt [4], Biochemical [136], Brick [13], Cement [15], Chemical [16], Coal [18], Coke [21], Concrete [23], Copper [26], Explosive [38], Fish [39], Food [41], Gas [45], Glass [47], Gold [48], Ice [57], Iron [58], Lead [59], Lumber [63], Metal [69], Oil [75], Paper [80], Petrochemical [137], Petrol [46], Plastic [84], Radioactive Material [90], Rubber [94], Sewage [101], Silver [105], Snow [106], Steel [109], Sugar [111], Textile [114], Tobacco [117], Uranium [120], Vegetation Product [121], Water [122], Zinc [126])

Reference #: **PL-04412\_2** Description: **Processing Facility / not intact / unknown (point)**

Label String: [Name] "Processing facility"  
 Characteristics: 1, 1  
 1 (Black, Condensed, 6 pt, Mixed case)

Product [PPO] = (Other [999], Unknown [0])

Symbol Samples

Processing facility

Protection Shed (AL210)

Generalization Rules (see Annex J): GA-9999, GC-9997

Protection Shed / all (line)



Symbol Graphic

Symbol Placement Instructions: The symbol is applied to the geometry of the feature.  
 Symbol Type: Complex

Component Ref #:	L00200	Component Type:	Line - Simple	Color Token:	Black
Description:	Black 1.5mm Solid Line				
Parameters:					
Line Weight:	1.5mm				

Symbol Rules

Reference #: **PS-04558** Description: **Protection Shed / all (line)** Criteria: All

Label Rules

Label Placement Rules (see Annex J): LP-3505

Reference #: **PL-04558\_1** Description: **Protection Shed / all (line)**

Label String: "Protection shed"  
 Characteristics: 1  
 1 (Black, Condensed, 6 pt, Mixed case)

Criteria:  
 N/A

Symbol Samples



## Protection Shed / all (point)



Symbol Graphic

Symbol Placement Instructions: Origin: Center of symbol

Symbol Type: Simple

Note: The symbol is aligned with the associated transportation feature.

Component Ref #:	P00152	Component Type:	Point - Simple	Color Token:	Black
Description:	Black 2.5mm length line with a 1.5mm lineweight				
Parameters:					
Line Weight:	1.5mm				
Length:	2.5mm				

### Symbol Rules

Reference #:	Description:	Criteria:
PS-04563	Protection Shed / all (point)	All

### Label Rules

Label Placement Rules (see Annex J): LP-3505

Reference #:	Description:	Criteria:
PL-04563_1	Protection Shed / all (point)	N/A

Label String: "Protection shed"  
 Characteristics: 1  
 1 (Black, Condensed, 6 pt, Mixed case)

### Symbol Samples

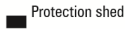

## Public Square (AL170)

Generalization Rules (see Annex J): GA-9999

## Public Square / all (area)

[NAM]

Symbol Graphic

Symbol Placement Instructions: Text label only. No graphic parameters

Symbol Type: Simple

### Symbol Rules

Reference #:	Description:	Criteria:
PS-04091	Public Square / all (area)	All

### Label Rules

Label Placement Rules (see Annex J): LP-3505, LP-9999

Reference #:	Description:	Criteria:
PL-04091_1	Public Square / all (area)	N/A

Label String: [Name]  
 Characteristics: 1  
 1 (Black, Condensed, 6 pt, Mixed case)

Symbol Samples

Union Square

**Pumping Station (AQ116)**

Generalization Rules (see Annex J): GA-9999

**Pumping Station / all (area)**



Symbol Graphic

Symbol Placement Instructions: The symbol is applied to the geometry of the feature.

Symbol Type: Simple

Component Ref #:	L00210	Component Type:	Line - Styled	Color Token:	Black
Description:	Black 0.1mm Dashed line (0.1mm wt, 1.0mm dash, 0.5mm gap)				
Parameters:					
Line Weight:	0.1mm	Dash Length:	1.0mm	Dash Spacing:	0.5mm

Symbol Rules

Reference #:	Description:	Criteria:
PS-04142	Pumping Station / all (area)	All

Label Rules

Label Placement Rules (see Annex J): LP-3506, LP-9950, LP-9999

Reference #:	Description:	Criteria:
PL-04142_1	Pumping Station / intact (area)	Condition of Facility [FUN] = (Fully Functional [6], Unknown [0])

Label String: [Product] "Pumping station"  
 Characteristics: 1, 1  
 1 (Black, Condensed, 6 pt, Mixed case)

Reference #:	Description:	Criteria:
PL-04142_2	Pumping Station / not intact (area)	Condition of Facility [FUN] = (Abandoned [2], Damaged [13], Destroyed [3], Dismantled [4], Under Construction [1])

Label String: [Product] "Pumping station" ("["Condition of Facility]")"  
 Characteristics: 1, 1, 22, 22, 22  
 1 (Black, Condensed, 6 pt, Mixed case)  
 22 (Black, Condensed, 6 pt, Lower case)

Symbol Samples

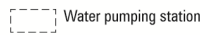

**Pumping Station / intact (point)**



Symbol Graphic

Symbol Placement Instructions: Origin: Center of symbol

Symbol Type: Simple

Component Ref #: P00006      Component Type: Point - Simple      Color Token: Black  
 Description: Black filled square with all sides 0.8mm  
Parameters:  
 Length: 0.8mm  
 Note: The component is a square and is filled with the solid color.

Symbol Rules

Reference #: Description: Criteria:  
**PS-04143**    **Pumping Station / intact (point)**      Condition of Facility [FUN] = (Fully Functional [6], Unknown [0])

Label Rules

Label Placement Rules (see Annex J): LP-3505, LP-9999

Reference #: Description: Criteria:  
**PL-04143\_1**    **Pumping Station / intact (point)**      N/A

Label String: [Product] "Pumping station"  
 Characteristics: 1, 1  
 1 (Black, Condensed, 6 pt, Mixed case)

Symbol Samples

■ Pumping station

■ Sewage pumping station

**Pumping Station / not intact (point)**



Symbol Graphic

Symbol Placement Instructions: Origin: Center of symbol

Symbol Type: Simple

Component Ref #: P00173      Component Type: Point - Shape      Color Token: Black/Black-12  
 Description: Not intact square 0.8mm  
Parameters:  
 Note: See Annex H for detailed drawing instructions.

Symbol Rules

Reference #: Description: Criteria:  
**PS-04917**    **Pumping Station / not intact (point)**      Condition of Facility [FUN] = (Abandoned [2], Damaged [13], Destroyed [3], Dismantled [4], Under Construction [1])

Label Rules

Label Placement Rules (see Annex J): LP-3505

Reference #: Description: Criteria:  
**PL-04917\_1**    **Pumping Station / not intact (point)**      N/A

Label String: "Pumping station"  
 Characteristics: 1  
 1 (Black, Condensed, 6 pt, Mixed case)

Symbol Samples

□ Pumping station

## Pylon (AT042)

### Pylon / non-obstruction (point)



Symbol Graphic

Symbol Placement Instructions: Origin: Center of dot

Symbol Type: Simple

Component Ref #:	P00010	Component Type:	Point - Shape	Color Token:	Black
Description:	Located object				
<a href="#">Parameters:</a>					
Note:	See Annex H for detailed drawing instructions.				

#### Symbol Rules

Reference #:	Description:	Criteria:
<b>PS-04866</b>	<b>Pylon / non-obstruction (point)</b>	Height Above Surface Level [HGT] < 46

#### Label Rules

Label Placement Rules (see Annex J): LP-3505

Reference #:	Description:	Criteria:
<b>PL-04866_1</b>	<b>Pylon / non-obstruction (point)</b>	N/A

Label String: "Pylon"  
 Characteristics: 1  
 1 (Black, Condensed, 6 pt, Mixed case)

#### Symbol Samples

○ Pylon

### Pylon / obstruction (point)



Symbol Graphic

Symbol Placement Instructions: Origin: Center of open circle

Symbol Type: Simple

Note: The vertical axis of the symbol is orientated perpendicular to the line element of the coincident Cableway, Communication Line or Power Line feature, with the top of the symbol pointing in a northerly direction.

Component Ref #:	P00292	Component Type:	Point - Shape	Color Token:	Blue072
Description:	Vertical obstruction pylon				
<a href="#">Parameters:</a>					
Note:	See Annex H for detailed drawing instructions.				

#### Symbol Rules

Reference #:	Description:	Criteria:
<b>PS-04947</b>	<b>Pylon / obstruction (point)</b>	Height Above Surface Level [HGT] >= 46

#### Label Rules

Label Placement Rules (see Annex J): LP-9992



Reference #: Description: Criteria:  
**PL-04947\_1** **Pylon / obstruction (point)** N/A

Label String: "Pylon"  
 [Highest Elevation]  
 "["[Height Above Surface Level]""]"  
 Characteristics: 15  
 46  
 95, 95, 95  
 15 (Blue072, Condensed, 6 pt, Mixed case)  
 46 (Blue072, Condensed, Bold, 6 pt, Lower case)

Symbol Samples



**Quarry (AA012)**

Generalization Rules (see Annex J): GA-9999, GC-9982

**Quarry / intact (area)**



Symbol Graphic

Symbol Placement Instructions: The symbol is applied to the geometry of the feature.

Symbol Type: Complex

Note: Component L00210 is applied to the perimeter and Component P00001 is placed in the center.

Component Ref #:	L00210	Component Type:	Line - Styled	Color Token:	Black
Description:	Black 0.1mm Dashed line (0.1mm wt, 1.0mm dash, 0.5mm gap)				
<u>Parameters:</u>					
Line Weight:	0.1mm	Dash Length:	1.0mm	Dash Spacing:	0.5mm

Component Ref #:	P00001	Component Type:	Point - Shape	Color Token:	Black
Description:	Extraction mine intact not peat				
<u>Parameters:</u>					
Note:	See Annex H for detailed drawing instructions.				

Symbol Rules

Reference #: Description: Criteria:  
**PS-04669** **Quarry / intact (area)** Condition of Facility [FUN] = (Fully Functional [6], Unknown [0])

Label Rules

Label Placement Rules (see Annex J): LP-3506, LP-4813, LP-9999

Reference #: Description: Criteria:  
**PL-04669\_1** **Quarry / intact / named / product known (area)** Name [NAM] <> "Unknown"

AND Product [PPO] = (Clay [17], Dolomite [35], Granite [50], Gravel [53], Marble [66], Rock [93], Sand [96], Stone [110], Madrepore [129])

Label String: [Name] "Quarry" "["[Product]""]"  
 Characteristics: 1, 1, 22, 22, 22  
 1 (Black, Condensed, 6 pt, Mixed case)  
 22 (Black, Condensed, 6 pt, Lower case)

**PL-04669\_2** **Quarry / intact / named / product unknown (area)** Name [NAM] <> "Unknown"

AND Product [PPO] = (Multiple [996], Other [999], Unknown [0])

Label String: [Name] "Quarry"  
 Characteristics: 1, 1  
 1 (Black, Condensed, 6 pt, Mixed case)

PL-04669\_3 Quarry / intact / unnamed / product known (area)

Name [NAM] = "Unknown"

AND Product [PPO] = (Clay [17], Dolomite [35], Granite [50], Gravel [53], Marble [66], Rock [93], Sand [96], Stone [110], Madrepore [129])

Label String: "Quarry" "("[Product]"")  
 Characteristics: 1, 22, 22, 22  
 1 (Black, Condensed, 6 pt, Mixed case)  
 22 (Black, Condensed, 6 pt, Lower case)

PL-04669\_4 Quarry / intact / unnamed / product unknown (area)

Name [NAM] = "Unknown"

AND Product [PPO] = (Multiple [996], Other [999], Unknown [0])

Label String: "Quarry"  
 Characteristics: 1  
 1 (Black, Condensed, 6 pt, Mixed case)

Symbol Samples



Quarry



Danby Quarry (marble)

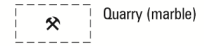

Quarry (marble)

Quarry / not intact (area)



Symbol Graphic

Symbol Placement Instructions: The symbol is applied to the geometry of the feature.

Symbol Type: Complex

Note: Component L00210 is applied to the perimeter and Component P00002 is placed in the center.

Component Ref #:	L00210	Component Type:	Line - Styled	Color Token:	Black
Description:	Black 0.1mm Dashed line (0.1mm wt, 1.0mm dash, 0.5mm gap)				
Parameters:					
Line Weight:	0.1mm	Dash Length:	1.0mm	Dash Spacing:	0.5mm

Component Ref #:	P00002	Component Type:	Point - Shape	Color Token:	Black
Description:	Extraction mine not intact not peat				
Parameters:					
Note:	See Annex H for detailed drawing instructions.				

Symbol Rules

Reference #:	Description:	Criteria:
PS-04670	Quarry / not intact (area)	Condition of Facility [FUN] = (Abandoned [2], Damaged [13], Destroyed [3], Dismantled [4], Under Construction [1])

Label Rules

Label Placement Rules (see Annex J):	LP-3506, LP-4813, LP-9999	
Reference #:	Description:	Criteria:
PL-04670_1	Quarry / not intact / named / product known (area)	Name [NAM] <> "Unknown"

AND Product [PPO] = (Clay [17], Dolomite [35], Granite [50], Gravel [53], Marble [66], Rock [93], Sand [96], Stone [110], Madrepore [129])

Label String: [Name] "Quarry" "["[Product]""]  
 Characteristics: 1, 1, 22, 22, 22  
 1 (Black, Condensed, 6 pt, Mixed case)  
 22 (Black, Condensed, 6 pt, Lower case)

PL-04670\_2 Quarry / not intact / named / product unknown (area) Name [NAM] <> "Unknown"

AND Product [PPO] = (Multiple [996], Other [999], Unknown [0])

Label String: [Name] "Quarry"  
 Characteristics: 1, 1  
 1 (Black, Condensed, 6 pt, Mixed case)

PL-04670\_3 Quarry / not intact / unnamed / product known (area) Name [NAM] = "Unknown"

AND Product [PPO] = (Clay [17], Dolomite [35], Granite [50], Gravel [53], Marble [66], Rock [93], Sand [96], Stone [110], Madrepore [129])

Label String: "Quarry" "["[Product]""]  
 Characteristics: 1, 22, 22, 22  
 1 (Black, Condensed, 6 pt, Mixed case)  
 22 (Black, Condensed, 6 pt, Lower case)

PL-04670\_4 Quarry / not intact / unnamed / product unknown (area) Name [NAM] = "Unknown"

AND Product [PPO] = (Multiple [996], Other [999], Unknown [0])

Label String: "Quarry"  
 Characteristics: 1  
 1 (Black, Condensed, 6 pt, Mixed case)

Symbol Samples



Quarry



Washington Quarry (stone)



Quarry (stone)

Quarry / intact (point)



Symbol Graphic

Symbol Placement Instructions: Origin: Center of symbol

Symbol Type: Simple

Component Ref #: P00001 Component Type: Point - Shape Color Token: Black  
 Description: Extraction mine intact not peat  
 Parameters:  
 Note: See Annex H for detailed drawing instructions.

Symbol Rules

Reference #: Description: Criteria:  
 PS-04671 Quarry / intact (point) Condition of Facility [FUN] = (Fully Functional [6], Unknown [0])

Label Rules

Label Placement Rules (see Annex J): LP-3505, LP-4813, LP-9999

Reference #: Description: Criteria:  
 PL-04671\_1 Quarry / intact / named / product known (point) Name [NAM] <> "Unknown"

AND Product [PPO] = (Clay [17], Dolomite [35], Granite [50], Gravel [53], Marble [66], Rock [93], Sand [96], Stone [110], Madrepore [129])

Label String: [Name] "Quarry" "["[Product]""]  
 Characteristics: 1, 1, 22, 22, 22  
 1 (Black, Condensed, 6 pt, Mixed case)  
 22 (Black, Condensed, 6 pt, Lower case)

PL-04671\_2 Quarry / intact / named / product unknown (point) Name [NAM] <> "Unknown"

AND Product [PPO] = (Multiple [996], Other [999], Unknown [0])

Label String: [Name] "Quarry"  
 Characteristics: 1, 1  
 1 (Black, Condensed, 6 pt, Mixed case)

PL-04671\_3 Quarry / intact / unnamed / product known (point) Name [NAM] = "Unknown"

Quarry / intact / unnamed / product known point AND Product [PPO] = (Clay [17], Dolomite [35], Granite [50], Gravel [53], Marble [66], Rock [93], Sand [96], Stone [110], Madrepore [129])

Label String: "Quarry" "["[Product]""]  
 Characteristics: 1, 22, 22, 22  
 1 (Black, Condensed, 6 pt, Mixed case)  
 22 (Black, Condensed, 6 pt, Lower case)

PL-04671\_4 Quarry / intact / unnamed / product unknown (point) Name [NAM] = "Unknown"

AND Product [PPO] = (Multiple [996], Other [999], Unknown [0])

Label String: "Quarry"  
 Characteristics: 1  
 1 (Black, Condensed, 6 pt, Mixed case)

Symbol Samples

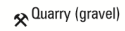

Quarry / not intact (point)



Symbol Graphic

Symbol Placement Instructions: Origin: Center of symbol  
 Symbol Type: Simple

Component Ref #: P00002 Component Type: Point - Shape Color Token: Black  
 Description: Extraction mine not intact not peat  
 Parameters:  
 Note: See Annex H for detailed drawing instructions.

Symbol Rules

Reference #: Description: Criteria:  
 PS-04672 Quarry / not intact (point) Condition of Facility [FUN] = (Abandoned [2], Damaged [13], Destroyed [3], Dismantled [4], Under Construction [1])

Label Rules

Label Placement Rules (see Annex J): LP-3505, LP-4813, LP-9999  
 Reference #: Description: Criteria:  
 PL-04672\_1 Quarry / not intact / named / product known (point) Name [NAM] <> "Unknown"

AND Product [PPO] = (Clay [17], Dolomite [35], Granite [50], Gravel [53], Marble [66], Rock [93], Sand [96], Stone [110], Madrepore [129])

Label String: [Name] "Quarry" "["[Product]"]"  
 Characteristics: 1, 1, 22, 22, 22  
 1 (Black, Condensed, 6 pt, Mixed case)  
 22 (Black, Condensed, 6 pt, Lower case)

PL-04672\_2 Quarry / not intact / named / product unknown (point) Name [NAM] <> "Unknown"

AND Product [PPO] = (Multiple [996], Other [999], Unknown [0])

Label String: [Name] "Quarry"  
 Characteristics: 1, 1  
 1 (Black, Condensed, 6 pt, Mixed case)

PL-04672\_3 Quarry / not intact / unnamed / product known (point) Name [NAM] = "Unknown"

AND Product [PPO] = (Clay [17], Dolomite [35], Granite [50], Gravel [53], Marble [66], Rock [93], Sand [96], Stone [110], Madrepore [129])

Label String: "Quarry" "["[Product]"]"  
 Characteristics: 1, 22, 22, 22  
 1 (Black, Condensed, 6 pt, Mixed case)  
 22 (Black, Condensed, 6 pt, Lower case)

PL-04672\_4 Quarry / not intact / unnamed / product unknown (point) Name [NAM] = "Unknown"

AND Product [PPO] = (Multiple [996], Other [999], Unknown [0])

Label String: "Quarry"  
 Characteristics: 1  
 1 (Black, Condensed, 6 pt, Mixed case)

Symbol Samples



Racetrack (AK130)

Generalization Rules (see Annex J): GA-9999, GC-9988

Racetrack / all (line)



Symbol Graphic

Symbol Placement Instructions: The symbol is applied to the geometry of the feature.  
 Symbol Type: Simple

Component Ref #:	L00013	Component Type:	Line - Simple	Color Token:	Black
Description:	Black 0.4mm Solid Line				
Parameters:					
Line Weight:	0.4mm				

Symbol Rules

Reference #:	Description:	Criteria:
PS-04060	Racetrack / all (line)	All

Label Rules

Label Placement Rules (see Annex J): LP-3505, LP-4813, LP-9999

Reference #:	Description:	Criteria:
PL-04060_1	Racetrack / all (line)	N/A

Label String: [Name] "Racetrack"  
 Characteristics: 1, 1  
 1 (Black, Condensed, 6 pt, Mixed case)

Symbol Samples



Racetrack



Taladega Superspeedway

Radar Station (AT045)

Radar Station / intact (point)



Symbol Graphic

Symbol Placement Instructions: Origin: Center of symbol  
 Symbol Type: Simple

Component Ref #: P00006      Component Type: Point - Simple      Color Token: Black  
 Description: Black filled square with all sides 0.8mm  
Parameters:  
 Length: 0.8mm  
 Note: The component is a square and is filled with the solid color.

Symbol Rules

Reference #: Description: Criteria:  
**PS-04159** Radar Station / intact (point) Condition of Facility [FUN] = (Fully Functional [6], Unknown [0])

Label Rules

Label Placement Rules (see Annex J): LP-3505, LP-4813, LP-9999

Reference #: Description: Criteria:  
**PL-04159\_1** Radar Station / intact (point) N/A

Label String: [Name] "Radar station"  
 Characteristics: 1, 1  
 1 (Black, Condensed, 6 pt, Mixed case)

Symbol Samples



Radar station



Gettysburg Air Force Radar Station

Radar Station / not intact (point)



Symbol Graphic

Symbol Placement Instructions: Origin: Center of symbol  
 Symbol Type: Simple

Component Ref #: P00173      Component Type: Point - Shape      Color Token: Black/Black-12  
 Description: Not intact square 0.8mm  
Parameters:  
 Note: See Annex H for detailed drawing instructions.

Symbol Rules

Reference #:	Description:	Criteria:
<b>PS-04918</b>	<b>Radar Station / not intact (point)</b>	Condition of Facility [FUN] = (Abandoned [2], Damaged [13], Destroyed [3], Dismantled [4], Under Construction [1])

Label Rules

Label Placement Rules (see Annex J): LP-3505

Reference #:	Description:	Criteria:
<b>PL-04918_1</b>	<b>Radar Station / not intact (point)</b>	N/A

Label String: "Radar station"  
 Characteristics: 1  
 1 (Black, Condensed, 6 pt, Mixed case)

Symbol Samples



Railway (AN010)

Generalization Rules (see Annex J): GA-9999

Railway / intact / broad, standard / electrified / >= 2 tracks (line)



Symbol Graphic

Symbol Placement Instructions: The symbol is applied to the geometry of the feature.  
 Symbol Type: Complex  
 Repeating Point and Interval: Component P00282 has an initial offset of 3.2mm; after that 12.8mm.  
 Repeating Point and Interval 2: Component P00278 has an initial offset of 9.6mm; after that 12.8mm.  
 Note: Components P00282 and P00278 are centered perpendicular to Component L00011 with the 0.7mm length line of P00282 on the northernmost side. No symbol is portrayed if the Vertical Relative Location [LOC] = Below Ground Surface [40].

Component Ref #:	L00011	Component Type:	Line - Simple	Color Token:	Black
Description:	Black 0.3mm Solid Line				
Parameters:					
Line Weight:	0.3mm				
Component Ref #:	P00282	Component Type:	Point - Shape	Color Token:	Black
Description:	Railway tick broad electrified double				
Parameters:					
Note:	See Annex H for detailed drawing instructions.				
Component Ref #:	P00278	Component Type:	Point - Shape	Color Token:	Black
Description:	Railway tick broad double				
Parameters:					
Note:	See Annex H for detailed drawing instructions.				

Symbol Rules

Reference #:	Description:	Criteria:
<b>PS-04383</b>	<b>Railway / intact / broad, standard / electrified / &gt;= 2 tracks (line)</b>	Condition of Facility [FUN] = (Fully Functional [6], Unknown [0])
	AND	Railway Gauge Classification [RGC] = (Broad [1], Standard [3], Unknown [0])
	AND	Railway Power Method [RRA] = (Electrified Track [1], Overhead Electrified [3])
	AND	Track or Lane Count [LTN] >= 2
	AND	Vertical Relative Location [LOC] = (Above Surface [45], On Surface [44], Unknown [0])
	AND	Railway in Road [RIR] = (Separated from Road [1000], Unknown [0])
	AND	Railway Use [RRC] = (Logging [8], Long-haul [33], Other [999], Unknown [0])

Label Rules

Label Placement Rules (see Annex J): LP-3630, LP-9999

Reference #:	Description:	Criteria:
--------------	--------------	-----------

**PL-04383\_1 Railway / intact / broad / electrified / > 2 tracks (line)**

Railway Gauge Classification [RGC] = Broad [1]

AND Track or Lane Count [LTN] > 2

**Label String:** [Name] [Track or Lane Count] "TRACKS" [Railway Gauge] "m"

**Characteristics:** 27, 28, 27, 28, 28,  
27 (Black, Light Condensed, Italic, 6 pt, Upper case)  
28 (Black, Light Condensed, Italic, 6 pt, Lower case)

**PL-04383\_2 Railway / intact / broad / electrified / 2 tracks (line)**

Railway Gauge Classification [RGC] = Broad [1]

AND Track or Lane Count [LTN] = 2

**Label String:** [Name] [Railway Gauge] "m"

**Characteristics:** 27, 28, 28  
27 (Black, Light Condensed, Italic, 6 pt, Upper case)  
28 (Black, Light Condensed, Italic, 6 pt, Lower case)

**PL-04383\_3 Railway / intact / standard / electrified / > 2 tracks (line)**

Railway Gauge Classification [RGC] = (Standard [3], Unknown [0])

AND Track or Lane Count [LTN] > 2

**Label String:** [Name] [Track or Lane Count] "TRACKS"

**Characteristics:** 27, 28, 27  
27 (Black, Light Condensed, Italic, 6 pt, Upper case)  
28 (Black, Light Condensed, Italic, 6 pt, Lower case)

**PL-04383\_4 Railway / intact / standard / electrified / 2 tracks (line)**

Railway Gauge Classification [RGC] = (Standard [3], Unknown [0])

AND Track or Lane Count [LTN] = 2

**Label String:** [Name]

**Characteristics:** 27  
27 (Black, Light Condensed, Italic, 6 pt, Upper case)

**Symbol Samples**



**Railway / intact / broad, standard / electrified / 1 track (line)**



Symbol Graphic

**Symbol Placement Instructions:** The symbol is applied to the geometry of the feature.

**Symbol Type:** Complex

**Repeating Point and Interval:** Component P00280 has an initial offset of 3.2mm; after that 12.8mm.

**Repeating Point and Interval 2:** Component P00044 has an initial offset of 9.6mm; after that 12.8mm.

**Note:** Components P00280 and P00044 are centered perpendicular to Component L00011 with the 0.7mm length line of P00280 on the northernmost side. No symbol is portrayed if the Vertical Relative Location [LOC] = Below Ground Surface [40].

<b>Component Ref #:</b>	L00011	<b>Component Type:</b>	Line - Simple	<b>Color Token:</b>	Black
<b>Description:</b>	Black 0.3mm Solid Line				
<b>Parameters:</b>					
<b>Line Weight:</b>	0.3mm				

<b>Component Ref #:</b>	P00280	<b>Component Type:</b>	Point - Shape	<b>Color Token:</b>	Black
<b>Description:</b>	Railway tick broad electrified				
<b>Parameters:</b>					
<b>Note:</b>	See Annex H for detailed drawing instructions.				

<b>Component Ref #:</b>	P00044	<b>Component Type:</b>	Point - Simple	<b>Color Token:</b>	Black
<b>Description:</b>	Black 1.5mm length line with a 0.15mm lineweight				
<b>Parameters:</b>					



Line Weight: 0.15mm  
 Length: 1.5mm

Symbol Rules

<p>Reference #: <b>PS-04382</b></p> <p>Description: <b>Railway / intact / broad, standard / electrified / 1 track (line)</b></p>	<p>Criteria:</p> <p>Condition of Facility [FUN] = (Fully Functional [6], Unknown [0])</p> <p>AND Railway Gauge Classification [RGC] = (Broad [1], Standard [3], Unknown [0])</p> <p>AND Railway Power Method [RRA] = (Electrified Track [1], Overhead Electrified [3])</p> <p>AND Track or Lane Count [LTN] &lt;= 1</p> <p>AND Vertical Relative Location [LOC] = (Above Surface [45], On Surface [44], Unknown [0])</p> <p>AND Railway in Road [RIR] = (Separated from Road [1000], Unknown [0])</p> <p>AND Railway Use [RRC] = (Logging [8], Long-haul [33], Other [999], Unknown [0])</p>
--	--

Label Rules

Label Placement Rules (see Annex J): LP-3630, LP-9999

<p>Reference #: <b>PL-04382_1</b></p> <p>Description: <b>Railway / intact / broad / electrified / 1 track (line)</b></p> <p>Label String: [Name] [Railway Gauge] "m"</p> <p>Characteristics: 27, 28, 28                  27 (Black, Light Condensed, Italic, 6 pt, Upper case)                  28 (Black, Light Condensed, Italic, 6 pt, Lower case)</p>	<p>Criteria:</p> <p>Railway Gauge Classification [RGC] = Broad [1]</p>
<p>Reference #: <b>PL-04382_2</b></p> <p>Description: <b>Railway / intact / standard / electrified / 1 track (line)</b></p> <p>Label String: [Name]</p> <p>Characteristics: 27                  27 (Black, Light Condensed, Italic, 6 pt, Upper case)</p>	<p>Criteria:</p> <p>Railway Gauge Classification [RGC] = (Standard [3], Unknown [0])</p>

Symbol Samples



Railway / intact / narrow / electrified / >= 2 tracks (line)



Symbol Graphic

**Symbol Placement Instructions:** The symbol is applied to the geometry of the feature.

**Symbol Type:** Complex

**Repeating Point and Interval:** Component P00281 has an initial offset of 3.2mm; after that 12.8mm on the northernmost side of Component L00011.

**Repeating Point and Interval 2:** Component P00277 has an initial offset of 9.6mm; after that 12.8mm on the southernmost side of Component L00011.

**Note:** Components P00281 and P00277 are perpendicular to and on alternating sides of Component L00011. No symbol is portrayed if the Vertical Relative Location [LOC] = Below Ground Surface [40].

Component Ref #: L00011	Component Type: Line - Simple	Color Token: Black
Description: Black 0.3mm Solid Line		
Parameters:		
Line Weight: 0.3mm		
Component Ref #: P00281	Component Type: Point - Shape	Color Token: Black
Description: Railway tick narrow electrified double		
Parameters:		
Note: See Annex H for detailed drawing instructions.		
Component Ref #: P00277	Component Type: Point - Shape	Color Token: Black
Description: Railway tick narrow double		
Parameters:		
Note: See Annex H for detailed drawing instructions.		

## Symbol Rules

Reference #:	Description:	Criteria:
<b>PS-04385</b>	<b>Railway / intact / narrow / electrified / &gt;= 2 tracks (line)</b>	Condition of Facility [FUN] = (Fully Functional [6], Unknown [0])
		AND Railway Gauge Classification [RGC] = (Monorail [6], Narrow [2])
		AND Railway Power Method [RRA] = (Electrified Track [1], Overhead Electrified [3])
		AND Track or Lane Count [LTN] >= 2
		AND Vertical Relative Location [LOC] = (Above Surface [45], On Surface [44], Unknown [0])
		AND Railway in Road [RIR] = (Separated from Road [1000], Unknown [0])
		AND Railway Use [RRC] = (Logging [8], Long-haul [33], Other [999], Unknown [0])

## Label Rules

Label Placement Rules (see Annex J): LP-3630, LP-9999

Reference #:	Description:	Criteria:
<b>PL-04385_1</b>	<b>Railway / intact / narrow / electrified / &gt; 2 tracks (line)</b>	Railway Gauge Classification [RGC] = Narrow [2]
		AND Track or Lane Count [LTN] > 2
	Label String: [Name] [Track or Lane Count] "TRACKS" [Track Information : Railway Gauge] "m"	
	Characteristics: 27, 28, 27, 28, 28 27 (Black, Light Condensed, Italic, 6 pt, Upper case) 28 (Black, Light Condensed, Italic, 6 pt, Lower case)	
<b>PL-04385_2</b>	<b>Railway / intact / narrow / electrified / 2 tracks (line)</b>	Railway Gauge Classification [RGC] = Narrow [2]
		AND Track or Lane Count [LTN] = 2
	Label String: [Name] [Track Information : Railway Gauge] "m"	
	Characteristics: 27, 28, 28 27 (Black, Light Condensed, Italic, 6 pt, Upper case) 28 (Black, Light Condensed, Italic, 6 pt, Lower case)	
<b>PL-04385_3</b>	<b>Railway / intact / monorail / electrified / &gt; 2 tracks (line)</b>	Railway Gauge Classification [RGC] = Monorail [6]
		AND Track or Lane Count [LTN] > 2
	Label String: [Name] [Railway Gauge Classification] [Track or Lane Count] "TRACKS"	
	Characteristics: 27, 27, 28, 27 27 (Black, Light Condensed, Italic, 6 pt, Upper case) 28 (Black, Light Condensed, Italic, 6 pt, Lower case)	
<b>PL-04385_4</b>	<b>Railway / intact / monorail / electrified / 2 tracks (line)</b>	Railway Gauge Classification [RGC] = Monorail [6]
		AND Track or Lane Count [LTN] = 2
	Label String: [Name] [Railway Gauge Classification]	
	Characteristics: 27, 27 27 (Black, Light Condensed, Italic, 6 pt, Upper case)	

## Symbol Samples



**Railway / intact / narrow / electrified / 1 track (line)**



Symbol Graphic

**Symbol Placement Instructions:** The symbol is applied to the geometry of the feature.

**Symbol Type:** Complex

**Repeating Point and Interval:** Component P00279 has an initial offset of 3.2mm; after that 12.8mm on the northernmost side of Component L00011.

**Repeating Point and Interval 2:** Component P00038 has an initial offset of 9.6mm; after that 12.8mm on the southernmost side of Component L00011.

**Note:** Components P00279 and P00038 are perpendicular to and on alternating sides of Component L00011. No symbol is portrayed if the Vertical Relative Location [LOC] = Below Ground Surface [40].

<b>Component Ref #:</b>	L00011	<b>Component Type:</b>	Line - Simple	<b>Color Token:</b>	Black
<b>Description:</b>	Black 0.3mm Solid Line				
<b>Parameters:</b>					
<b>Line Weight:</b>	0.3mm				
<b>Component Ref #:</b>	P00279	<b>Component Type:</b>	Point - Shape	<b>Color Token:</b>	Black
<b>Description:</b>	Railway tick narrow electrified				
<b>Parameters:</b>					
<b>Note:</b>	See Annex H for detailed drawing instructions.				
<b>Component Ref #:</b>	P00038	<b>Component Type:</b>	Point - Simple	<b>Color Token:</b>	Black
<b>Description:</b>	Black 0.75mm length line with a 0.15mm lineweight				
<b>Parameters:</b>					
<b>Line Weight:</b>	0.15mm				
<b>Length:</b>	0.75mm				

### Symbol Rules

<b>Reference #:</b>	<b>Description:</b>	<b>Criteria:</b>
<b>PS-04384</b>	<b>Railway / intact / narrow / electrified / 1 track (line)</b>	Condition of Facility [FUN] = (Fully Functional [6], Unknown [0])
		AND Railway Gauge Classification [RGC] = (Monorail [6], Narrow [2])
		AND Railway Power Method [RRA] = (Electrified Track [1], Overhead Electrified [3])
		AND Track or Lane Count [LTN] <= 1
		AND Vertical Relative Location [LOC] = (Above Surface [45], On Surface [44], Unknown [0])
		AND Railway in Road [RIR] = (Separated from Road [1000], Unknown [0])
		AND Railway Use [RRC] = (Logging [8], Long-haul [33], Other [999], Unknown [0])

### Label Rules

Label Placement Rules (see Annex J): LP-3630, LP-9999

<b>Reference #:</b>	<b>Description:</b>	<b>Criteria:</b>
<b>PL-04384_1</b>	<b>Railway / intact / narrow / electrified / 1 track (line)</b>	Railway Gauge Classification [RGC] = Narrow [2]
	<b>Label String:</b> [Name] [Track Information : Railway Gauge] "m"	
	<b>Characteristics:</b> 27, 28, 28	
	27 (Black, Light Condensed, Italic, 6 pt, Upper case)	
	28 (Black, Light Condensed, Italic, 6 pt, Lower case)	
<b>PL-04384_2</b>	<b>Railway / intact / monorail / electrified / 1 track (line)</b>	Railway Gauge Classification [RGC] = Monorail [6]
	<b>Label String:</b> [Name] [Railway Gauge Classification]	
	<b>Characteristics:</b> 27, 27	
	27 (Black, Light Condensed, Italic, 6 pt, Upper case)	

### Symbol Samples



### Railway / intact / broad, standard / non-electrified / >= 2 tracks (line)

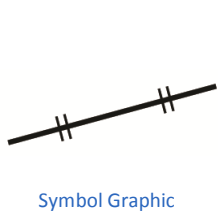

**Symbol Placement Instructions:** The symbol is applied to the geometry of the feature.

**Symbol Type:** Complex

**Repeating Point and Interval:** Component P00278 has an initial offset of 3.2mm; after that 6.4mm.

**Note:** Component P00278 is centered perpendicular to Component L00011. No symbol is portrayed if the Vertical Relative Location [LOC] = Below Ground Surface [40].

<b>Component Ref #:</b>	L00011	<b>Component Type:</b>	Line - Simple	<b>Color Token:</b>	Black
<b>Description:</b>	Black 0.3mm Solid Line				
<b>Parameters:</b>					
<b>Line Weight:</b>	0.3mm				
<b>Component Ref #:</b>	P00278	<b>Component Type:</b>	Point - Shape	<b>Color Token:</b>	Black
<b>Description:</b>	Railway tick broad double				
<b>Parameters:</b>					
<b>Note:</b>	See Annex H for detailed drawing instructions.				

## Symbol Rules

Reference #:	Description:	Criteria:
<b>PS-04378</b>	<b>Railway / intact / broad, standard / non-electrified / &gt;= 2 tracks (line)</b>	Condition of Facility [FUN] = (Fully Functional [6], Unknown [0])
		AND Railway Gauge Classification [RGC] = (Broad [1], Standard [3], Unknown [0])
		AND Railway Power Method [RRA] = (Non-electrified [4], Unknown [0])
		AND Track or Lane Count [LTN] >= 2
		AND Vertical Relative Location [LOC] = (Above Surface [45], On Surface [44], Unknown [0])
		AND Railway in Road [RIR] = (Separated from Road [1000], Unknown [0])
		AND Railway Use [RRC] = (Logging [8], Long-haul [33], Other [999], Unknown [0])

## Label Rules

Label Placement Rules (see Annex J): LP-3630, LP-9999

Reference #:	Description:	Criteria:
<b>PL-04378_1</b>	<b>Railway / intact / broad / non-electrified / &gt; 2 tracks (line)</b>	Railway Gauge Classification [RGC] = Broad [1]
		AND Track or Lane Count [LTN] > 2
	<b>Label String:</b> [Name] [Track or Lane Count] "TRACKS" [Railway Gauge] "m"	
	<b>Characteristics:</b> 27, 28, 27, 28, 28, 27 (Black, Light Condensed, Italic, 6 pt, Upper case) 28 (Black, Light Condensed, Italic, 6 pt, Lower case)	
<b>PL-04378_2</b>	<b>Railway / intact / broad / non-electrified / 2 tracks (line)</b>	Railway Gauge Classification [RGC] = Broad [1]
		AND Track or Lane Count [LTN] = 2
	<b>Label String:</b> [Name] [Railway Gauge] "m"	
	<b>Characteristics:</b> 27, 28, 28 27 (Black, Light Condensed, Italic, 6 pt, Upper case) 28 (Black, Light Condensed, Italic, 6 pt, Lower case)	
<b>PL-04378_3</b>	<b>Railway / intact / standard / non-electrified / &gt; 2 tracks (line)</b>	Railway Gauge Classification [RGC] = (Standard [3], Unknown [0])
		AND Track or Lane Count [LTN] > 2
	<b>Label String:</b> [Name][Track or Lane Count] "TRACKS"	
	<b>Characteristics:</b> 27, 28, 27 27 (Black, Light Condensed, Italic, 6 pt, Upper case) 28 (Black, Light Condensed, Italic, 6 pt, Lower case)	
<b>PL-04378_4</b>	<b>Railway / intact / standard / non-electrified / 2 tracks (line)</b>	Railway Gauge Classification [RGC] = (Standard [3], Unknown [0])

AND Track or Lane Count [LTN] = 2

Label String: [Name]  
 Characteristics: 27  
 27 (Black, Light Condensed, Italic, 6 pt, Upper case)

Symbol Samples



Railway / intact / broad, standard / non-electrified / 1 track (line)

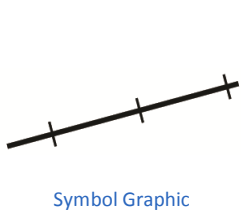

Symbol Placement Instructions: The symbol is applied to the geometry of the feature.  
 Symbol Type: Complex  
 Repeating Point and Interval: Component P00044 has an initial offset of 3.2mm; after that 6.4mm.

Note: Component P00044 is centered perpendicular to Component L00011. No symbol is portrayed if the Vertical Relative Location [LOC] = Below Ground Surface [40].

Component Ref #:	L00011	Component Type:	Line - Simple	Color Token:	Black
Description:	Black 0.3mm Solid Line				
Parameters:					
Line Weight:	0.3mm				
Component Ref #:	P00044	Component Type:	Point - Simple	Color Token:	Black
Description:	Black 1.5mm length line with a 0.15mm lineweight				
Parameters:					
Line Weight:	0.15mm				
Length:	1.5mm				

Symbol Rules

Reference #:	Description:	Criteria:
PS-04377	Railway / intact / broad, standard / non-electrified / 1 track (line)	Condition of Facility [FUN] = (Fully Functional [6], Unknown [0])
		AND Railway Gauge Classification [RGC] = (Broad [1], Standard [3], Unknown [0])
		AND Railway Power Method [RRA] = (Non-electrified [4], Unknown [0])
		AND Track or Lane Count [LTN] <= 1
		AND Vertical Relative Location [LOC] = (Above Surface [45], On Surface [44], Unknown [0])
		AND Railway in Road [RIR] = (Separated from Road [1000], Unknown [0])
		AND Railway Use [RRC] = (Logging [8], Long-haul [33], Other [999], Unknown [0])

Label Rules

Label Placement Rules (see Annex J): LP-3630, LP-9999

Reference #:	Description:	Criteria:
PL-04377_1	Railway / intact / broad / non-electrified / 1 track (line)	Railway Gauge Classification [RGC] = Broad [1]
	Label String: [Name] [Railway Gauge] "m"	
	Characteristics: 27, 28, 28	
	27 (Black, Light Condensed, Italic, 6 pt, Upper case)	
	28 (Black, Light Condensed, Italic, 6 pt, Lower case)	
PL-04377_2	Railway / intact / standard / non-electrified / 1 track (line)	Railway Gauge Classification [RGC] = (Standard [3], Unknown [0])
	Label String: [Name]	
	Characteristics: 27	
	27 (Black, Light Condensed, Italic, 6 pt, Upper case)	

Symbol Samples



**Railway / intact / narrow / non-electrified / >= 2 tracks (line)**

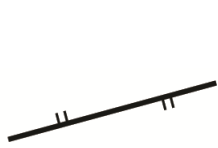

Symbol Graphic

**Symbol Placement Instructions:** The symbol is applied to the geometry of the feature.

**Symbol Type:** Complex

**Repeating Point and Interval:** Component P00277 has an initial offset of 3.2mm; after that 6.4mm.

**Note:** Component P00277 is perpendicular to and on alternating sides of Component L00011. No symbol is portrayed if the Vertical Relative Location [LOC] = Below Ground Surface [40].

<b>Component Ref #:</b>	L00011	<b>Component Type:</b>	Line - Simple	<b>Color Token:</b>	Black
<b>Description:</b>	Black 0.3mm Solid Line				
<b>Parameters:</b>					
<b>Line Weight:</b>	0.3mm				
<b>Component Ref #:</b>	P00277	<b>Component Type:</b>	Point - Shape	<b>Color Token:</b>	Black
<b>Description:</b>	Railway tick narrow double				
<b>Parameters:</b>					
<b>Note:</b>	See Annex H for detailed drawing instructions.				

**Symbol Rules**

Reference #:	Description:	Criteria:
<b>PS-04395</b>	<b>Railway / intact / narrow / non-electrified / &gt;= 2 tracks (line)</b>	Condition of Facility [FUN] = (Fully Functional [6], Unknown [0])
		AND Railway Gauge Classification [RGC] = (Monorail [6], Narrow [2])
		AND Railway Power Method [RRA] = (Non-electrified [4], Unknown [0])
		AND Track or Lane Count [LTN] >= 2
		AND Vertical Relative Location [LOC] = (Above Surface [45], On Surface [44], Unknown [0])
		AND Railway in Road [RIR] = (Separated from Road [1000], Unknown [0])
		AND Railway Use [RRC] = (Logging [8], Long-haul [33], Other [999], Unknown [0])

**Label Rules**

Reference #:	Description:	Criteria:
	<b>Label Placement Rules (see Annex J):</b> LP-3630, LP-9999	
<b>PL-04395_1</b>	<b>Railway / intact / narrow / non-electrified / &gt; 2 tracks (line)</b>	Railway Gauge Classification [RGC] = Narrow [2]
		AND Track or Lane Count [LTN] > 2
	<b>Label String:</b> [Name] [Track or Lane Count] "TRACKS" [Track Information : Railway Gauge] "m"	
	<b>Characteristics:</b> 27, 28, 27, 28, 28	
	27 (Black, Light Condensed, Italic, 6 pt, Upper case)	
	28 (Black, Light Condensed, Italic, 6 pt, Lower case)	
<b>PL-04395_2</b>	<b>Railway / intact / narrow / non-electrified / 2 tracks (line)</b>	Railway Gauge Classification [RGC] = Narrow [2]
		AND Track or Lane Count [LTN] = 2
	<b>Label String:</b> [Name] [Track Information : Railway Gauge] "m"	
	<b>Characteristics:</b> 27, 28, 28	
	27 (Black, Light Condensed, Italic, 6 pt, Upper case)	
	28 (Black, Light Condensed, Italic, 6 pt, Lower case)	
<b>PL-04395_3</b>	<b>Railway / intact / monorail / non-electrified / &gt; 2 tracks (line)</b>	Railway Gauge Classification [RGC] = Monorail [6]

AND Track or Lane Count [LTN] > 2

**Label String:** [Name] [Railway Gauge Classification] [Track or Lane Count] "TRACKS"

**Characteristics:** 27, 27, 28, 27

27 (Black, Light Condensed, Italic, 6 pt, Upper case)

28 (Black, Light Condensed, Italic, 6 pt, Lower case)

**PL-04395\_4 Railway / intact / monorail / non-electrified / 2 tracks (line)**

Railway Gauge Classification [RGC] = Monorail [6]

AND Track or Lane Count [LTN] = 2

**Label String:** [Name] [Railway Gauge Classification]

**Characteristics:** 27, 27

27 (Black, Light Condensed, Italic, 6 pt, Upper case)

**Symbol Samples**



**Railway / intact / narrow / non-electrified / 1 track (line)**



Symbol Graphic

**Symbol Placement Instructions:** The symbol is applied to the geometry of the feature.

**Symbol Type:** Complex

**Repeating Point and Interval:** Component P00038 has an initial offset of 3.2mm; after that 6.4mm.

**Note:** Components P00038 is perpendicular to and on alternating sides of Component L00011. No symbol is portrayed if the Vertical Relative Location [LOC] = Below Ground Surface [40].

<b>Component Ref #:</b> L00011	<b>Component Type:</b> Line - Simple	<b>Color Token:</b> Black
<b>Description:</b> Black 0.3mm Solid Line		
<b>Parameters:</b>		
<b>Line Weight:</b> 0.3mm		
<b>Component Ref #:</b> P00038	<b>Component Type:</b> Point - Simple	<b>Color Token:</b> Black
<b>Description:</b> Black 0.75mm length line with a 0.15mm lineweight		
<b>Parameters:</b>		
<b>Line Weight:</b> 0.15mm		
<b>Length:</b> 0.75mm		

**Symbol Rules**

<b>Reference #:</b> PS-04394	<b>Description:</b> Railway / intact / narrow / non-electrified / 1 track (line)	<b>Criteria:</b> Condition of Facility [FUN] = (Fully Functional [6], Unknown [0])
		AND Railway Gauge Classification [RGC] = (Monorail [6], Narrow [2])
		AND Railway Power Method [RRA] = (Non-electrified [4], Unknown [0])
		AND Track or Lane Count [LTN] <= 1
		AND Vertical Relative Location [LOC] = (Above Surface [45], On Surface [44], Unknown [0])
		AND Railway in Road [RIR] = (Separated from Road [1000], Unknown [0])
		AND Railway Use [RRC] = (Logging [8], Long-haul [33], Other [999], Unknown [0])

**Label Rules**

**Label Placement Rules (see Annex J):** LP-3630, LP-9999

<b>Reference #:</b> PL-04394_1	<b>Description:</b> Railway / intact / narrow / non-electrified / 1 track (line)	<b>Criteria:</b> Railway Gauge Classification [RGC] = Narrow [2]
--------------------------------	--	--

**Label String:** [Name] [Track Information : Railway Gauge] "m"

**Characteristics:** 27, 28, 28

27 (Black, Light Condensed, Italic, 6 pt, Upper case)

28 (Black, Light Condensed, Italic, 6 pt, Lower case)

**PL-04394\_2 Railway / intact / monorail / non-electrified / 1 track (line)**

Railway Gauge Classification [RGC] = Monorail [6]

**Label String:** [Name] [Railway Gauge Classification]  
**Characteristics:** 27, 27  
 27 (Black, Light Condensed, Italic, 6 pt, Upper case)

**Symbol Samples**



**Railway / not intact / broad, standard / electrified / >= 2 tracks (line)**



Symbol Graphic

**Symbol Placement Instructions:** The symbol is applied to the geometry of the feature.  
**Symbol Type:** Complex  
**Repeating Point and Interval:** Component P00282 is centered on the first dash then every other dash of Component L00039.  
**Repeating Point and Interval 2:** Component P00278 is centered on the second dash then every other dash of Component L00039.  
**Note:** Components P00282 and P00278 are centered perpendicular to Component L00039 with the 0.7mm length line of P00282 on the northernmost side. No symbol is portrayed if the Vertical Relative Location [LOC] = Below Ground Surface [40].

<b>Component Ref #:</b>	L00039	<b>Component Type:</b>	Line - Styled	<b>Color Token:</b>	Black
<b>Description:</b>	Black 0.3mm Dashed Line (0.3mm wt, 5.9mm dash, 0.5mm gap)				
<b>Parameters:</b>					
<b>Line Weight:</b>	0.3mm	<b>Dash Length:</b>	5.9mm	<b>Dash Spacing:</b>	0.5mm
<b>Component Ref #:</b>	P00282	<b>Component Type:</b>	Point - Shape	<b>Color Token:</b>	Black
<b>Description:</b>	Railway tick broad electrified double				
<b>Parameters:</b>					
<b>Note:</b>	See Annex H for detailed drawing instructions.				
<b>Component Ref #:</b>	P00278	<b>Component Type:</b>	Point - Shape	<b>Color Token:</b>	Black
<b>Description:</b>	Railway tick broad double				
<b>Parameters:</b>					
<b>Note:</b>	See Annex H for detailed drawing instructions.				

**Symbol Rules**

<b>Reference #:</b>	<b>Description:</b>	<b>Criteria:</b>
<b>PS-04391</b>	<b>Railway / not intact / broad, standard / electrified / &gt;= 2 tracks (line)</b>	Condition of Facility [FUN] = (Abandoned [2], Damaged [13], Under Construction [1])
	AND	Railway Gauge Classification [RGC] = (Broad [1], Standard [3], Unknown [0])
	AND	Railway Power Method [RRA] = (Electrified Track [1], Overhead Electrified [3])
	AND	Track or Lane Count [LTN] >= 2
	AND	Vertical Relative Location [LOC] = (Above Surface [45], On Surface [44], Unknown [0])
	AND	Railway in Road [RIR] = (Separated from Road [1000], Unknown [0])
	AND	Railway Use [RRC] = (Logging [8], Long-haul [33], Other [999], Unknown [0])

**Label Rules**

**Label Placement Rules (see Annex J):** LP-3630, LP-9950, LP-9999

<b>Reference #:</b>	<b>Description:</b>	<b>Criteria:</b>
<b>PL-04391_1</b>	<b>Railway / not intact / broad / electrified / &gt; 2 tracks (line)</b>	Railway Gauge Classification [RGC] = Broad [1]
	AND	Track or Lane Count [LTN] > 2

**Label String:** [Name] [Track or Lane Count] "TRACKS" [Railway Gauge] "m" ("[Condition of Facility]")  
**Characteristics:** 27, 28, 27, 28, 28, 27, 27, 27  
 27 (Black, Light Condensed, Italic, 6 pt, Upper case)  
 28 (Black, Light Condensed, Italic, 6 pt, Lower case)



**PL-04391\_2** **Railway / not intact / standard / electrified / > 2 tracks (line)** Railway Gauge Classification [RGC] = (Standard [3], Unknown [0])

AND Track or Lane Count [LTN] > 2

**Label String:** [Name] [Track or Lane Count] "TRACKS" "("[Condition of Facility]"")  
**Characteristics:** 27, 28, 27, 27, 27, 27  
 27 (Black, Light Condensed, Italic, 6 pt, Upper case)  
 28 (Black, Light Condensed, Italic, 6 pt, Lower case)

**PL-04391\_3** **Railway / not intact / broad / electrified / 2 tracks (line)** Railway Gauge Classification [RGC] = Broad [1]

AND Track or Lane Count [LTN] = 2

**Label String:** [Name] [Railway Gauge] "m" "("[Condition of Facility]"")  
**Characteristics:** 27, 28, 28, 27, 27, 27  
 27 (Black, Light Condensed, Italic, 6 pt, Upper case)  
 28 (Black, Light Condensed, Italic, 6 pt, Lower case)

**PL-04391\_4** **Railway / not intact / standard / electrified / 2 tracks (line)** Railway Gauge Classification [RGC] = (Standard [3], Unknown [0])

AND Track or Lane Count [LTN] = 2

**Label String:** [Name] "("[Condition of Facility]"")  
**Characteristics:** 27, 27, 27, 27  
 27 (Black, Light Condensed, Italic, 6 pt, Upper case)

**Symbol Samples**

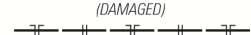
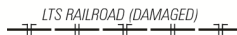

**Railway / not intact / broad, standard / electrified / 1 track (line)**



Symbol Graphic

**Symbol Placement Instructions:** The symbol is applied to the geometry of the feature.  
**Symbol Type:** Complex  
**Repeating Point and Interval:** Component P00280 is centered on the first dash then every other dash of Component L00039.  
**Repeating Point and Interval 2:** Component P00044 is centered on the second dash and then every other dash of Component L00039.  
**Note:** Components P00280 and P00044 are centered perpendicular to Component L00039 with the 0.7mm length line of P00280 on the northernmost side. No symbol is portrayed if the Vertical Relative Location [LOC] = Below Ground Surface [40].

<b>Component Ref #:</b> L00039	<b>Component Type:</b> Line - Styled	<b>Color Token:</b> Black
<b>Description:</b> Black 0.3mm Dashed Line (0.3mm wt, 5.9mm dash, 0.5mm gap)		
<b>Parameters:</b>		
<b>Line Weight:</b> 0.3mm	<b>Dash Length:</b> 5.9mm	<b>Dash Spacing:</b> 0.5mm
<b>Component Ref #:</b> P00280	<b>Component Type:</b> Point - Shape	<b>Color Token:</b> Black
<b>Description:</b> Railway tick broad electrified		
<b>Parameters:</b>		
<b>Note:</b> See Annex H for detailed drawing instructions.		
<b>Component Ref #:</b> P00044	<b>Component Type:</b> Point - Simple	<b>Color Token:</b> Black
<b>Description:</b> Black 1.5mm length line with a 0.15mm lineweight		
<b>Parameters:</b>		
<b>Line Weight:</b> 0.15mm		
<b>Length:</b> 1.5mm		

**Symbol Rules**

**Reference #:** **Description:** **Criteria:**  
**PS-04390** **Railway / not intact / broad, standard / electrified / 1 track (line)** Condition of Facility [FUN] = (Abandoned [2], Damaged [13], Under Construction [1])  
 AND Railway Gauge Classification [RGC] = (Broad [1], Standard [3], Unknown [0])

- AND Railway Power Method [RRA] = (Electrified Track [1], Overhead Electrified [3])
- AND Track or Lane Count [LTN] <= 1
- AND Vertical Relative Location [LOC] = (Above Surface [45], On Surface [44], Unknown [0])
- AND Railway in Road [RIR] = (Separated from Road [1000], Unknown [0])
- AND Railway Use [RRC] = (Logging [8], Long-haul [33], Other [999], Unknown [0])

**Label Rules**

Label Placement Rules (see Annex J): LP-3630, LP-9950, LP-9999

<p><b>Reference #:</b> <b>Description:</b></p> <p><b>PL-04390_1</b> <b>Railway / not intact / broad / electrified / 1 track (line)</b></p> <p><b>Label String:</b> [Name] [Railway Gauge] "m" ("[Condition of Facility]")</p> <p><b>Characteristics:</b> 27, 28, 28, 27, 27, 27 27 (Black, Light Condensed, Italic, 6 pt, Upper case) 28 (Black, Light Condensed, Italic, 6 pt, Lower case)</p>	<p><b>Criteria:</b></p> <p>Railway Gauge Classification [RGC] = Broad [1]</p>
<p><b>PL-04390_2</b> <b>Railway / not intact / standard / electrified / 1 track (line)</b></p> <p><b>Label String:</b> [Name] ("[Condition of Facility]")</p> <p><b>Characteristics:</b> 27, 27, 27, 27 27 (Black, Light Condensed, Italic, 6 pt, Upper case)</p>	<p>Railway Gauge Classification [RGC] = (Standard [3], Unknown [0])</p>

**Symbol Samples**



**Railway / not intact / narrow / electrified / >= 2 tracks (line)**



Symbol Graphic

**Symbol Placement Instructions:** The symbol is applied to the geometry of the feature.

**Symbol Type:** Complex

**Repeating Point and Interval:** Component P00281 is centered on the first dash then every other dash, on the northernmost side of Component L00039.

**Repeating Point and Interval 2:** Component P00277 is centered on the second dash then every other dash, on the southernmost side of Component L00039.

**Note:** Components P00281 and P00277 are perpendicular to and on alternating sides of Component L00039. No symbol is portrayed if the Vertical Relative Location [LOC] = Below Ground Surface [40].

<b>Component Ref #:</b> L00039	<b>Component Type:</b> Line - Styled	<b>Color Token:</b> Black
<b>Description:</b> Black 0.3mm Dashed Line (0.3mm wt, 5.9mm dash, 0.5mm gap)		
<b>Parameters:</b>		
<b>Line Weight:</b> 0.3mm	<b>Dash Length:</b> 5.9mm	<b>Dash Spacing:</b> 0.5mm
<b>Component Ref #:</b> P00281	<b>Component Type:</b> Point - Shape	<b>Color Token:</b> Black
<b>Description:</b> Railway tick narrow electrified double		
<b>Parameters:</b>		
<b>Note:</b> See Annex H for detailed drawing instructions.		
<b>Component Ref #:</b> P00277	<b>Component Type:</b> Point - Shape	<b>Color Token:</b> Black
<b>Description:</b> Railway tick narrow double		
<b>Parameters:</b>		
<b>Note:</b> See Annex H for detailed drawing instructions.		

**Symbol Rules**

<p><b>Reference #:</b> <b>Description:</b></p> <p><b>PS-04393</b> <b>Railway / not intact / narrow / electrified / &gt;= 2 tracks (line)</b></p>	<p><b>Criteria:</b></p> <p>Condition of Facility [FUN] = (Abandoned [2], Damaged [13], Under Construction [1])</p> <ul style="list-style-type: none"> <li>AND Railway Gauge Classification [RGC] = (Monorail [6], Narrow [2])</li> <li>AND Railway Power Method [RRA] = (Electrified Track [1], Overhead Electrified [3])</li> <li>AND Track or Lane Count [LTN] &gt;= 2</li> <li>AND Vertical Relative Location [LOC] = (Above Surface [45], On Surface [44], Unknown [0])</li> <li>AND Railway in Road [RIR] = (Separated from Road [1000], Unknown [0])</li> </ul>
--	---

AND Railway Use [RRC] = (Logging [8], Long-haul [33], Other [999], Unknown [0])

**Label Rules**

Label Placement Rules (see Annex J): LP-3630, LP-9950, LP-9999

- |   |   |
|---|---|
| <p><b>Reference #:</b> <b>PL-04393_1</b></p> <p><b>Description:</b> <b>Railway / not intact / narrow / electrified / &gt; 2 tracks (line)</b></p>   | <p><b>Criteria:</b> Railway Gauge Classification [RGC] = Narrow [2]</p> <p>AND Track or Lane Count [LTN] &gt; 2</p> <p><b>Label String:</b> [Name] [Track or Lane Count] "TRACKS" "("[Condition of Facility]"") [Track Information : Railway Gauge] "m"</p> <p><b>Characteristics:</b> 27, 28, 27, 27, 27, 27, 28, 28<br/>27 (Black, Light Condensed, Italic, 6 pt, Upper case)<br/>28 (Black, Light Condensed, Italic, 6 pt, Lower case)</p> |
| <p><b>Reference #:</b> <b>PL-04393_2</b></p> <p><b>Description:</b> <b>Railway / not intact / narrow / electrified / 2 tracks (line)</b></p>        | <p><b>Criteria:</b> Railway Gauge Classification [RGC] = Narrow [2]</p> <p>AND Track or Lane Count [LTN] = 2</p> <p><b>Label String:</b> [Name] "("[Condition of Facility]"") [Track Information : Railway Gauge] "m"</p> <p><b>Characteristics:</b> 27, 27, 27, 27, 28, 28<br/>27 (Black, Light Condensed, Italic, 6 pt, Upper case)<br/>28 (Black, Light Condensed, Italic, 6 pt, Lower case)</p>   |
| <p><b>Reference #:</b> <b>PL-04393_3</b></p> <p><b>Description:</b> <b>Railway / not intact / monorail / electrified / &gt; 2 tracks (line)</b></p> | <p><b>Criteria:</b> Railway Gauge Classification [RGC] = Monorail[6]</p> <p>AND Track or Lane Count [LTN] &gt; 2</p> <p><b>Label String:</b> [Name] [Railway Gauge Classification] [Track or Lane Count] "TRACKS" "("[Condition of Facility]"")</p> <p><b>Characteristics:</b> 27, 27, 28, 27, 27, 27, 27<br/>27 (Black, Light Condensed, Italic, 6 pt, Upper case)<br/>28 (Black, Light Condensed, Italic, 6 pt, Lower case)</p>             |
| <p><b>Reference #:</b> <b>PL-04393_4</b></p> <p><b>Description:</b> <b>Railway / not intact / monorail / electrified / 2 tracks (line)</b></p>      | <p><b>Criteria:</b> Railway Gauge Classification [RGC] = Monorail[6]</p> <p>AND Track or Lane Count [LTN] = 2</p> <p><b>Label String:</b> [Name] [Railway Gauge Classification] "("[Condition of Facility]"")</p> <p><b>Characteristics:</b> 27, 27, 27, 27, 27<br/>27 (Black, Light Condensed, Italic, 6 pt, Upper case)</p>   |

**Symbol Samples**



**Railway / not intact / narrow / electrified / 1 track (line)**



Symbol Graphic

**Symbol Placement Instructions:** The symbol is applied to the geometry of the feature.

**Symbol Type:** Complex

**Repeating Point and Interval:** Component P00279 is centered on the first dash then every other dash, on the northernmost side of Component L00039.

**Repeating Point and Interval 2:** Component P00038 is centered on the second dash then every other dash, on the southernmost side of Component L00039.

**Note:** Components P00279 and P00038 are perpendicular to and on alternating sides of Component L00039. No symbol is portrayed if the Vertical Relative Location [LOC] = Below Ground Surface [40].

<b>Component Ref #:</b> L00039	<b>Component Type:</b> Line - Styled	<b>Color Token:</b> Black
<b>Description:</b> Black 0.3mm Dashed Line (0.3mm wt, 5.9mm dash, 0.5mm gap)		
<b>Parameters:</b>		
<b>Line Weight:</b> 0.3mm	<b>Dash Length:</b> 5.9mm	<b>Dash Spacing:</b> 0.5mm

Component Ref #: P00279      Component Type: Point - Shape      Color Token: Black  
 Description: Railway tick narrow electrified  
[Parameters:](#)  
 Note: See Annex H for detailed drawing instructions.

Component Ref #: P00038      Component Type: Point - Simple      Color Token: Black  
 Description: Black 0.75mm length line with a 0.15mm lineweight  
[Parameters:](#)  
 Line Weight: 0.15mm  
 Length: 0.75mm

**Symbol Rules**

Reference #:	Description:	Criteria:
<b>PS-04392</b>	<b>Railway / not intact / narrow / electrified / 1 track (line)</b>	Condition of Facility [FUN] = (Abandoned [2], Damaged [13], Under Construction [1])
	AND	Railway Gauge Classification [RGC] = (Monorail [6], Narrow [2])
	AND	Railway Power Method [RRA] = (Electrified Track [1], Overhead Electrified [3])
	AND	Track or Lane Count [LTN] <= 1
	AND	Vertical Relative Location [LOC] = (Above Surface [45], On Surface [44], Unknown [0])
	AND	Railway in Road [RIR] = (Separated from Road [1000], Unknown [0])
	AND	Railway Use [RRC] = (Logging [8], Long-haul [33], Other [999], Unknown [0])

**Label Rules**

Label Placement Rules (see Annex J): LP-3630, LP-9950, LP-9999

Reference #:	Description:	Criteria:
<b>PL-04392_1</b>	<b>Railway / not intact / narrow / electrified / 1 track (line)</b>	Railway Gauge Classification [RGC] = Narrow [2]

Label String: [Name] "["[Condition of Facility]" [Track Information : Railway Gauge] "m"  
 Characteristics: 27, 27, 27, 27, 28, 28  
 27 (Black, Light Condensed, Italic, 6 pt, Upper case)  
 28 (Black, Light Condensed, Italic, 6 pt, Lower case)

<b>PL-04392_2</b>	<b>Railway / not intact / monorail / electrified / 1 track (line)</b>	Railway Gauge Classification [RGC] = Monorail [6]
-------------------	---	---

Label String: [Name] [Railway Gauge Classification] "["[Condition of Facility]"  
 Characteristics: 27, 27, 27, 27, 27  
 27 (Black, Light Condensed, Italic, 6 pt, Upper case)

**Symbol Samples**

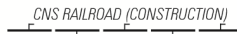

**Railway / not intact / broad, standard / non-electrified / >= 2 tracks (line)**



Symbol Graphic

Symbol Placement Instructions: The symbol is applied to the geometry of the feature.

Symbol Type: Complex

Repeating Point and Interval: Component P00278 is centered on every dash of Component L00039.

Note: Component P00278 is centered perpendicular to Component L00039. No symbol is portrayed if the Vertical Relative Location [LOC] = Below Ground Surface [40].

Component Ref #:	L00039	Component Type:	Line - Styled	Color Token:	Black
Description:	Black 0.3mm Dashed Line (0.3mm wt, 5.9mm dash, 0.5mm gap)				
<a href="#">Parameters:</a>					
Line Weight:	0.3mm	Dash Length:	5.9mm	Dash Spacing:	0.5mm

Component Ref #:	P00278	Component Type:	Point - Shape	Color Token:	Black
Description:	Railway tick broad double				
<a href="#">Parameters:</a>					

Note: See Annex H for detailed drawing instructions.

### Symbol Rules

Reference #:	Description:	Criteria:
<b>PS-04387</b>	<b>Railway / not intact / broad, standard / non-electrified / &gt;= 2 tracks (line)</b>	Condition of Facility [FUN] = (Abandoned [2], Damaged [13], Under Construction [1])
	AND	Railway Gauge Classification [RGC] = (Broad [1], Standard [3], Unknown [0])
	AND	Railway Power Method [RRA] = (Non-electrified [4], Unknown [0])
	AND	Track or Lane Count [LTN] >= 2
	AND	Vertical Relative Location [LOC] = (On Surface [44], Unknown [0])
	AND	Railway in Road [RIR] = (Separated from Road [1000], Unknown [0])
	AND	Railway Use [RRC] = (Logging [8], Long-haul [33], Other [999], Unknown [0])

### Label Rules

Label Placement Rules (see Annex J): LP-3630, LP-9950, LP-9999

Reference #:	Description:	Criteria:
<b>PL-04387_1</b>	<b>Railway / not intact / broad / non-electrified / &gt; 2 tracks (line)</b>	Railway Gauge Classification [RGC] = Broad [1]
	AND	Track or Lane Count [LTN] > 2
	<b>Label String:</b>	[Name] [Track or Lane Count] "TRACKS" [Railway Gauge] "m" ("[Condition of Facility]")
	<b>Characteristics:</b>	27, 28, 27, 28, 28, 27, 27, 27 27 (Black, Light Condensed, Italic, 6 pt, Upper case) 28 (Black, Light Condensed, Italic, 6 pt, Lower case)
<b>PL-04387_2</b>	<b>Railway / not intact / standard / non-electrified / &gt; 2 tracks (line)</b>	Railway Gauge Classification [RGC] = (Standard [3], Unknown [0])
	AND	Track or Lane Count [LTN] > 2
	<b>Label String:</b>	[Name] [Track or Lane Count] "TRACKS" ("[Condition of Facility]")
	<b>Characteristics:</b>	27, 28, 27, 27, 27, 27 27 (Black, Light Condensed, Italic, 6 pt, Upper case) 28 (Black, Light Condensed, Italic, 6 pt, Lower case)
<b>PL-04387_3</b>	<b>Railway / not intact / broad / non-electrified / 2 tracks (line)</b>	Railway Gauge Classification [RGC] = Broad [1]
	AND	Track or Lane Count [LTN] = 2
	<b>Label String:</b>	[Name] [Railway Gauge] "m" ("[Condition of Facility]")
	<b>Characteristics:</b>	27, 28, 28, 27, 27, 27 27 (Black, Light Condensed, Italic, 6 pt, Upper case) 28 (Black, Light Condensed, Italic, 6 pt, Lower case)
<b>PL-04387_4</b>	<b>Railway / not intact / standard / non-electrified / 2 tracks (line)</b>	Railway Gauge Classification [RGC] = (Standard [3], Unknown [0])
	AND	Track or Lane Count [LTN] = 2
	<b>Label String:</b>	[Name] ("[Condition of Facility]")
	<b>Characteristics:</b>	27, 27, 27, 27 27 (Black, Light Condensed, Italic, 6 pt, Upper case)

### Symbol Samples



### Railway / not intact / broad, standard / non-electrified / 1 track (line)



Symbol Graphic

**Symbol Placement Instructions:** The symbol is applied to the geometry of the feature.

**Symbol Type:** Complex

**Repeating Point and Interval:** Component P00044 is centered on every dash of Component L00039.

**Note:** Component P00044 is centered perpendicular to Component L00039. No symbol is portrayed if the Vertical Relative Location [LOC] = Below Ground Surface [40].

<b>Component Ref #:</b> L00039	<b>Component Type:</b> Line - Styled	<b>Color Token:</b> Black
<b>Description:</b> Black 0.3mm Dashed Line (0.3mm wt, 5.9mm dash, 0.5mm gap)		
<u>Parameters:</u>		
<b>Line Weight:</b> 0.3mm	<b>Dash Length:</b> 5.9mm	<b>Dash Spacing:</b> 0.5mm
<b>Component Ref #:</b> P00044	<b>Component Type:</b> Point - Simple	<b>Color Token:</b> Black
<b>Description:</b> Black 1.5mm length line with a 0.15mm lineweight		
<u>Parameters:</u>		
<b>Line Weight:</b> 0.15mm	<b>Length:</b> 1.5mm	

### Symbol Rules

Reference #:	Description:	Criteria:
<b>PS-04386</b>	<b>Railway / not intact / broad, standard / non-electrified / 1 track (line)</b>	Condition of Facility [FUN] = (Abandoned [2], Damaged [13], Under Construction [1])
	AND	Railway Gauge Classification [RGC] = (Broad [1], Standard [3], Unknown [0])
	AND	Railway Power Method [RRA] = (Non-electrified [4], Unknown [0])
	AND	Track or Lane Count [LTN] <= 1
	AND	Vertical Relative Location [LOC] = (Above Surface [45], On Surface [44], Unknown [0])
	AND	Railway in Road [RIR] = (Separated from Road [1000], Unknown [0])
	AND	Railway Use [RRC] = (Logging [8], Long-haul [33], Other [999], Unknown [0])

### Label Rules

Label Placement Rules (see Annex J): LP-3630, LP-9950, LP-9999

Reference #:	Description:	Criteria:
<b>PL-04386_1</b>	<b>Railway / not intact / broad / non-electrified / 1 track (line)</b>	Railway Gauge Classification [RGC] = Broad [1]
	<b>Label String:</b> [Name] [Railway Gauge] "m" "["[Condition of Facility]"	
	<b>Characteristics:</b> 27, 28, 28, 27, 27, 27 27 (Black, Light Condensed, Italic, 6 pt, Upper case) 28 (Black, Light Condensed, Italic, 6 pt, Lower case)	
<b>PL-04386_2</b>	<b>Railway / not intact / standard / non-electrified / 1 track (line)</b>	Railway Gauge Classification [RGC] = (Standard [3], Unknown [0])
	<b>Label String:</b> [Name] "["[Condition of Facility]"	
	<b>Characteristics:</b> 27, 27, 27, 27 27 (Black, Light Condensed, Italic, 6 pt, Upper case)	

### Symbol Samples



### Railway / not intact / narrow / non-electrified / >= 2 tracks (line)



Symbol Graphic

**Symbol Placement Instructions:** The symbol is applied to the geometry of the feature.

**Symbol Type:** Complex

**Repeating Point and Interval:** Component P00277 is centered on every dash of Component L00039.

**Note:** Component P00277 is perpendicular to and on alternating sides of Component L00039. No symbol is portrayed if the Vertical Relative Location [LOC] = Below Ground Surface [40].

<b>Component Ref #:</b> L00039	<b>Component Type:</b> Line - Styled	<b>Color Token:</b> Black
<b>Description:</b> Black 0.3mm Dashed Line (0.3mm wt, 5.9mm dash, 0.5mm gap)		
<u>Parameters:</u>		
<b>Line Weight:</b> 0.3mm	<b>Dash Length:</b> 5.9mm	<b>Dash Spacing:</b> 0.5mm
<b>Component Ref #:</b> P00277	<b>Component Type:</b> Point - Shape	<b>Color Token:</b> Black
<b>Description:</b> Railway tick narrow double		
<u>Parameters:</u>		
<b>Note:</b> See Annex H for detailed drawing instructions.		

### Symbol Rules

Reference #:	Description:	Criteria:
<b>PS-04389</b>	<b>Railway / not intact / narrow / non-electrified / &gt;= 2 tracks (line)</b>	Condition of Facility [FUN] = (Abandoned [2], Damaged [13], Under Construction [1])
		AND Railway Gauge Classification [RGC] = (Monorail [6], Narrow [2])
		AND Railway Power Method [RRA] = (Non-electrified [4], Unknown [0])
		AND Track or Lane Count [LTN] >= 2
		AND Vertical Relative Location [LOC] = (Above Surface [45], On Surface [44], Unknown [0])
		AND Railway in Road [RIR] = (Separated from Road [1000], Unknown [0])
		AND Railway Use [RRC] = (Logging [8], Long-haul [33], Other [999], Unknown [0])

### Label Rules

Reference #:	Description:	Criteria:
<b>Label Placement Rules (see Annex J):</b> LP-3630, LP-9950, LP-9999		
<b>PL-04389_1</b>	<b>Railway / not intact / narrow / non-electrified / &gt; 2 tracks (line)</b>	Railway Gauge Classification [RGC] = Narrow [2]
		AND Track or Lane Count [LTN] > 2
	<b>Label String:</b> [Name] [Track or Lane Count] "TRACKS" "("[Condition of Facility]" [Track Information : Railway Gauge] "m"	
	<b>Characteristics:</b> 27, 28, 27, 27, 27, 27, 28, 28 27 (Black, Light Condensed, Italic, 6 pt, Upper case) 28 (Black, Light Condensed, Italic, 6 pt, Lower case)	
<b>PL-04389_2</b>	<b>Railway / not intact / narrow / non-electrified / 2 tracks (line)</b>	Railway Gauge Classification [RGC] = Narrow [2]
		AND Track or Lane Count [LTN] = 2
	<b>Label String:</b> [Name] "("[Condition of Facility]" [Track Information : Railway Gauge] "m"	
	<b>Characteristics:</b> 27, 27, 27, 27, 28, 28 27 (Black, Light Condensed, Italic, 6 pt, Upper case) 28 (Black, Light Condensed, Italic, 6 pt, Lower case)	
<b>PL-04389_3</b>	<b>Railway / non-intact / monorail / non-electrified / &gt; 2 tracks (line)</b>	Railway Gauge Classification [RGC] = Monorail[6]
		AND Track or Lane Count [LTN] > 2
	<b>Label String:</b> [Name] [Railway Gauge Classification] [Track or Lane Count] "TRACKS" "("[Condition of Facility]"	
	<b>Characteristics:</b> 27, 27, 28, 27, 27, 27, 27 27 (Black, Light Condensed, Italic, 6 pt, Upper case) 28 (Black, Light Condensed, Italic, 6 pt, Lower case)	
<b>PL-04389_4</b>	<b>Railway / non-intact / monorail / non-electrified / 2 tracks (line)</b>	Railway Gauge Classification [RGC] = Monorail[6]

AND Track or Lane Count [LTN] = 2

**Label String:** [Name] [Railway Gauge Classification] "("[Condition of Facility]")"  
**Characteristics:** 27, 27, 27, 27, 27  
 27 (Black, Light Condensed, Italic, 6 pt, Upper case)

Symbol Samples



Railway / not intact / narrow / non-electrified / 1 track (line)



Symbol Graphic

**Symbol Placement Instructions:** The symbol is applied to the geometry of the feature.

**Symbol Type:** Complex

**Repeating Point and Interval:** Component P00038 is centered on every dash of Component L00039.

**Note:** Component P00038 is perpendicular to and on alternating sides of Component L00039. No symbol is portrayed if the Vertical Relative Location [LOC] = Below Ground Surface [40].

<b>Component Ref #:</b>	L00039	<b>Component Type:</b>	Line - Styled	<b>Color Token:</b>	Black
<b>Description:</b>	Black 0.3mm Dashed Line (0.3mm wt, 5.9mm dash, 0.5mm gap)				
<b>Parameters:</b>					
<b>Line Weight:</b>	0.3mm	<b>Dash Length:</b>	5.9mm	<b>Dash Spacing:</b>	0.5mm
<b>Component Ref #:</b>	P00038	<b>Component Type:</b>	Point - Simple	<b>Color Token:</b>	Black
<b>Description:</b>	Black 0.75mm length line with a 0.15mm linewidth				
<b>Parameters:</b>					
<b>Line Weight:</b>	0.15mm				
<b>Length:</b>	0.75mm				

Symbol Rules

<b>Reference #:</b>	<b>Description:</b>	<b>Criteria:</b>
PS-04388	Railway / not intact / narrow / non-electrified / 1 track (line)	Condition of Facility [FUN] = (Abandoned [2], Damaged [13], Under Construction [1])
		AND Railway Gauge Classification [RGC] = (Monorail [6], Narrow [2])
		AND Railway Power Method [RRA] = (Non-electrified [4], Unknown [0])
		AND Track or Lane Count [LTN] <= 1
		AND Vertical Relative Location [LOC] = (Above Surface [45], On Surface [44], Unknown [0])
		AND Railway in Road [RIR] = (Separated from Road [1000], Unknown [0])
		AND Railway Use [RRC] = (Logging [8], Long-haul [33], Other [999], Unknown [0])

Label Rules

Label Placement Rules (see Annex J): LP-3630, LP-9950, LP-9999

<b>Reference #:</b>	<b>Description:</b>	<b>Criteria:</b>
PL-04388_1	Railway / not intact / narrow / non-electrified / 1 track (line)	Railway Gauge Classification [RGC] = Narrow [2]
	<b>Label String:</b> [Name] "("[Condition of Facility]")" [Track Information : Railway Gauge] "m"	
	<b>Characteristics:</b> 27, 27, 27, 27, 28, 28 27 (Black, Light Condensed, Italic, 6 pt, Upper case) 28 (Black, Light Condensed, Italic, 6 pt, Lower case)	
PL-04388_2	Railway / not intact / monorail/ non-electrified / 1 track (line)	Railway Gauge Classification [RGC] = Monorail [6]
	<b>Label String:</b> [Name] [Railway Gauge Classification] "("[Condition of Facility]")"	
	<b>Characteristics:</b> 27, 27, 27, 27, 27 27 (Black, Light Condensed, Italic, 6 pt, Upper case)	

Symbol Samples



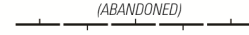

## Railway / intact / railway in road (line)



Symbol Graphic

**Symbol Placement Instructions:** The symbol is applied to the geometry of the feature.

**Symbol Type:** Complex

**Repeating Point and Interval:** Component P00038 has an initial offset of 3.2mm; after that 6.4mm.

**Note:** The symbol is a combination of two lines and one point. Display Level from bottom to top: Component L00232, Component L00231, and Component P00038. Component P00038 is centered on and perpendicular to Component L00232. No symbol is portrayed if the Vertical Relative Location [LOC] = Below Ground Surface [40].

<b>Component Ref #:</b>	L00232	<b>Component Type:</b>	Line - Simple	<b>Color Token:</b>	Black
<b>Description:</b>	Black 0.75mm Solid Line				
<b>Parameters:</b>					
<b>Line Weight:</b>	0.75mm				
<b>Component Ref #:</b>	L00231	<b>Component Type:</b>	Line - Simple	<b>Color Token:</b>	PaperWhite
<b>Description:</b>	PaperWhite 0.45mm Solid Line				
<b>Parameters:</b>					
<b>Line Weight:</b>	0.45mm				
<b>Component Ref #:</b>	P00038	<b>Component Type:</b>	Point - Simple	<b>Color Token:</b>	Black
<b>Description:</b>	Black 0.75mm length line with a 0.15mm lineweight				
<b>Parameters:</b>					
<b>Line Weight:</b>	0.15mm				
<b>Length:</b>	0.75mm				

### Symbol Rules

Reference #:	Description:	Criteria:
PS-04379	Railway / intact / railway in road (line)	Condition of Facility [FUN] = (Fully Functional [6], Unknown [0])
		AND Vertical Relative Location [LOC] = (On Surface [44], Unknown [0])
		AND Railway in Road [RIR] = (In Road [1001])

### Label Rules

Label Placement Rules (see Annex J): LP-3630, LP-9999

Reference #:	Description:	Criteria:
PL-04379_1	Railway / intact / railway in road (line)	N/A
	<b>Label String:</b> [Name]	
	<b>Characteristics:</b> 27	
	27 (Black, Light Condensed, Italic, 6 pt, Upper case)	

### Symbol Samples

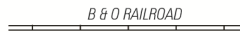

## Railway / not intact / railway in road (line)

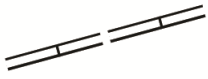

Symbol Graphic

**Symbol Placement Instructions:** The symbol is applied to the geometry of the feature.

**Symbol Type:** Complex

**Repeating Point and Interval:** Component P00038 is centered on every dash of Component L00230.

**Note:** The complex line is a combination of two lines and one point. Display Level from bottom to top: Component L00230, Component L00231, and Component P00038. Component P00038 is perpendicular to Component L00230. No symbol is portrayed if the Vertical Relative Location [LOC] = Below Ground Surface [40].

<b>Component Ref #:</b>	L00230	<b>Component Type:</b>	Line - Styled	<b>Color Token:</b>	Black
<b>Description:</b>	Black 0.75mm Dashed Line (0.75mm wt, 5.9mm dash, 0.5mm gap)				
<b>Parameters:</b>					
<b>Line Weight:</b>	0.75mm	<b>Dash Length:</b>	5.9mm	<b>Dash Spacing:</b>	0.5mm
<b>Component Ref #:</b>	L00231	<b>Component Type:</b>	Line - Simple	<b>Color Token:</b>	PaperWhite
<b>Description:</b>	PaperWhite 0.45mm Solid Line				
<b>Parameters:</b>					
<b>Line Weight:</b>	0.45mm				
<b>Component Ref #:</b>	P00038	<b>Component Type:</b>	Point - Simple	<b>Color Token:</b>	Black
<b>Description:</b>	Black 0.75mm length line with a 0.15mm lineweight				
<b>Parameters:</b>					
<b>Line Weight:</b>	0.15mm				
<b>Length:</b>	0.75mm				

### Symbol Rules

<b>Reference #:</b>	<b>Description:</b>	<b>Criteria:</b>
PS-04439	Railway / not intact / railway in road (line)	Condition of Facility [FUN] = (Abandoned [2], Damaged [13], Under Construction [1])
		AND Vertical Relative Location [LOC] = (Above Surface [45], On Surface [44], Unknown [0])
		AND Railway in Road [RIR] = In Road [1001]

### Label Rules

Label Placement Rules (see Annex J): LP-3630, LP-9950, LP-9999

<b>Reference #:</b>	<b>Description:</b>	<b>Criteria:</b>
PL-04439_1	Railway / not intact / railway in road (line)	N/A

**Label String:** [Name] "("[Condition of Facility]")"  
**Characteristics:** 27, 27, 27, 27  
 27 (Black, Light Condensed, Italic, 6 pt, Upper case)

### Symbol Samples



## Railway / intact / carline (line)



Symbol Graphic

**Symbol Placement Instructions:** The symbol is applied to the geometry of the feature.

**Symbol Type:** Complex

**Repeating Point and Interval:** Component P00044 has an initial offset of 1.9mm; after that 3.8mm.

**Note:** Component P00044 is centered perpendicular to Component L00008. No symbol is portrayed if the Vertical Relative Location [LOC] = Below Ground Surface [40].

<b>Component Ref #:</b>	L00008	<b>Component Type:</b>	Line - Simple	<b>Color Token:</b>	Black
<b>Description:</b>	Black 0.15mm Solid Line				
<b>Parameters:</b>					
<b>Line Weight:</b>	0.15mm				

Component Ref #: P00044      Component Type: Point - Simple      Color Token: Black  
 Description: Black 1.5mm length line with a 0.15mm lineweight  
Parameters:  
 Line Weight: 0.15mm  
 Length: 1.5mm

**Symbol Rules**

Reference #:	Description:	Criteria:
<b>PS-04380</b>	<b>Railway / intact / carline (line)</b>	Condition of Facility [FUN] = (Fully Functional [6], Unknown [0])
	AND	Vertical Relative Location [LOC] = (On Surface [44], Unknown [0])
	AND	Railway in Road [RIR] = (Separated from Road [1000], Unknown [0])
	AND	Railway Use [RRC] = (Automated Transit System [32], Carline [2], Funicular [15], Tramway [14], Underground Railway [6])

**Label Rules**

Label Placement Rules (see Annex J): LP-3630, LP-9999

Reference #:	Description:	Criteria:
<b>PL-04380_1</b>	<b>Railway / intact / carline (line)</b>	N/A
	Label String: [Name] [Railway Use]	
	Characteristics: 27, 27	
	27 (Black, Light Condensed, Italic, 6 pt, Upper case)	

**Symbol Samples**



**Railway / not intact / carline (line)**



Symbol Graphic

Symbol Placement Instructions: The symbol is applied to the geometry of the feature.  
 Symbol Type: Complex  
 Repeating Point and Interval: Component P00044 is centered on every dash of Component L00198.  
 Note: Component P00044 is centered perpendicular to Component L00198. No symbol is portrayed if the Vertical Relative Location [LOC] = Below Ground Surface [40].

Component Ref #: L00198      Component Type: Line - Styled      Color Token: Black  
 Description: Black 0.15mm Dashed Line (0.15mm wt, 3.3mm dash, 0.5mm gap)  
Parameters:  
 Line Weight: 0.15mm      Dash Length: 3.3mm      Dash Spacing: 0.5mm

Component Ref #: P00044      Component Type: Point - Simple      Color Token: Black  
 Description: Black 1.5mm length line with a 0.15mm lineweight  
Parameters:  
 Line Weight: 0.15mm  
 Length: 1.5mm

**Symbol Rules**

Reference #:	Description:	Criteria:
<b>PS-04438</b>	<b>Railway / not intact / carline (line)</b>	Condition of Facility [FUN] = (Abandoned [2], Damaged [13], Under Construction [1])
	AND	Vertical Relative Location [LOC] = (Above Surface [45], On Surface [44], Unknown [0])
	AND	Railway in Road [RIR] = (Separated from Road [1000], Unknown [0])
	AND	Railway Use [RRC] = (Automated Transit System [32], Carline [2], Funicular [15], Tramway [14], Underground Railway [6])

**Label Rules**

Label Placement Rules (see Annex J): LP-3630, LP-9950, LP-9999

Reference #:	Description:	Criteria:
--------------	--------------	-----------

PL-04438\_1 Railway / not intact / carline (line) N/A

Label String: [Name] [Railway Use] ("["Condition of Facility]")  
 Characteristics: 27, 27, 27, 27, 27  
 27 (Black, Light Condensed, Italic, 6 pt, Upper case)

Symbol Samples

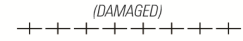

Railway / dismantled, destroyed (line)

Symbol Placement Instructions: The symbol is applied to the geometry of the feature.  
 Symbol Type: Simple

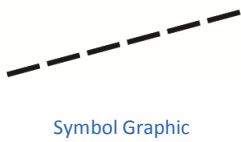

Component Ref #:	L00036	Component Type:	Line - Styled	Color Token:	Black
Description:	Black 0.3mm Dashed Line (0.3mm wt, 2.0mm dash, 0.5mm gap)				
Parameters:					
Line Weight:	0.3mm	Dash Length:	2.0mm	Dash Spacing:	0.5mm

Symbol Rules

Reference #:	Description:	Criteria:
PS-04381	Railway / dismantled, destroyed (line)	Condition of Facility [FUN] = (Destroyed [6], Dismantled [5])

Label Rules

Label Placement Rules (see Annex J): LP-3630, LP-9999

Reference #:	Description:	Criteria:
PL-04381_1	Railway / dismantled, destroyed (line)	N/A

Label String: [Condition of Facility] "railway"  
 Characteristics: 10, 28  
 10 (Black, Light Condensed, Italic, 6 pt, Mixed case)  
 28 (Black, Light Condensed, Italic, 6 pt, Lower case)

Symbol Samples



Railway Sidetrack (AN050)

Generalization Rules (see Annex J): GA-9999

Railway Sidetrack / intact / broad, standard / electrified (line)

Symbol Placement Instructions: The symbol is applied to the geometry of the feature.  
 Symbol Type: Complex



Symbol Graphic

Repeating Point and Interval: Component P00280 has an initial offset of 3.2mm; after that 12.8mm.

Repeating Point and Interval 2: Component P00044 has an initial offset of 9.6mm; after that 12.8mm.

Note: Components P00280 and P00044 are centered perpendicular to Component L00008 with the 0.7mm length line of P00280 on the northernmost side. No symbol is portrayed if the Vertical Relative Location [LOC] = Below Ground Surface [40].

Component Ref #:	L00008	Component Type:	Line - Simple	Color Token:	Black
Description:	Black 0.15mm Solid Line				
<a href="#">Parameters:</a>					
Line Weight:	0.15mm				
Component Ref #:	P00280	Component Type:	Point - Shape	Color Token:	Black
Description:	Railway tick broad electrified				
<a href="#">Parameters:</a>					
Note:	See Annex H for detailed drawing instructions.				
Component Ref #:	P00044	Component Type:	Point - Simple	Color Token:	Black
Description:	Black 1.5mm length line with a 0.15mm lineweight				
<a href="#">Parameters:</a>					
Line Weight:	0.15mm				
Length:	1.5mm				

### Symbol Rules

Reference #:	Description:	Criteria:
PS-04124	<b>Railway Sidetrack / intact / broad, standard / electrified (line)</b>	Condition of Facility [FUN] = (Fully Functional [6], Unknown [0])
	AND	Railway Gauge Classification [RGC] = (Broad [1], Standard [3], Unknown [0])
	AND	Railway Power Method [RRA] = (Electrified Track [1], Overhead Electrified [3])
	AND	Railway in Road [RIR] = (Separated from Road [1000], Unknown [0])

### Symbol Samples

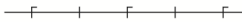

### Railway Sidetrack / intact / narrow / electrified (line)

Symbol Graphic

**Symbol Placement Instructions:** The symbol is applied to the geometry of the feature.

**Symbol Type:** Complex

**Repeating Point and Interval:** Component P00279 has an initial offset of 3.2mm; after that 12.8mm on the northernmost side of Component L00008.

**Repeating Point and Interval 2:** Component P00038 has an initial offset of 9.6mm; after that 12.8mm on the southernmost side of Component L00008.

**Note:** Components P00279 and P00038 are perpendicular to and on alternating sides of Component L00008. No symbol is portrayed if the Vertical Relative Location [LOC] = Below Ground Surface [40].

Component Ref #:	L00008	Component Type:	Line - Simple	Color Token:	Black
Description:	Black 0.15mm Solid Line				
<a href="#">Parameters:</a>					
Line Weight:	0.15mm				
Component Ref #:	P00279	Component Type:	Point - Shape	Color Token:	Black
Description:	Railway tick narrow electrified				
<a href="#">Parameters:</a>					
Note:	See Annex H for detailed drawing instructions.				
Component Ref #:	P00038	Component Type:	Point - Simple	Color Token:	Black
Description:	Black 0.75mm length line with a 0.15mm lineweight				
<a href="#">Parameters:</a>					
Line Weight:	0.15mm				
Length:	0.75mm				

### Symbol Rules

Reference #:	Description:	Criteria:
PS-04125	<b>Railway Sidetrack / intact / narrow / electrified (line)</b>	Condition of Facility [FUN] = (Fully Functional [6], Unknown [0])
	AND	Railway Gauge Classification [RGC] = (Monorail [6], Narrow [2])
	AND	Railway Power Method [RRA] = (Electrified Track [1], Overhead Electrified [3])

AND Railway in Road [RIR] = (Separated from Road [1000], Unknown [0])

Symbol Samples



**Railway Sidetrack / intact / broad, standard / non-electrified (line)**

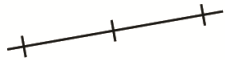

Symbol Graphic

**Symbol Placement Instructions:** The symbol is applied to the geometry of the feature.

**Symbol Type:** Complex

**Repeating Point and Interval:** Component P00044 has an initial offset of 3.2mm; after that 6.4mm.

**Note:** Component P00044 is centered perpendicular to Component L00008. No symbol is portrayed if the Vertical Relative Location [LOC] = Below Ground Surface [40].

<b>Component Ref #:</b>	L00008	<b>Component Type:</b>	Line - Simple	<b>Color Token:</b>	Black
<b>Description:</b>	Black 0.15mm Solid Line				
<b>Parameters:</b>					
<b>Line Weight:</b>	0.15mm				

<b>Component Ref #:</b>	P00044	<b>Component Type:</b>	Point - Simple	<b>Color Token:</b>	Black
<b>Description:</b>	Black 1.5mm length line with a 0.15mm lineweight				
<b>Parameters:</b>					
<b>Line Weight:</b>	0.15mm				
<b>Length:</b>	1.5mm				

Symbol Rules

**Reference #:** Description:

**PS-04122** Railway Sidetrack / intact / broad, standard / non-electrified (line)

**Criteria:**

Condition of Facility [FUN] = (Fully Functional [6], Unknown [0])

AND Railway Gauge Classification [RGC] = (Broad [1], Standard [3], Unknown [0])

AND Railway Power Method [RRA] = (Non-electrified [4], Unknown [0])

AND Railway in Road [RIR] = (Separated from Road [1000], Unknown [0])

Symbol Samples



**Railway Sidetrack / intact / narrow / non-electrified (line)**



Symbol Graphic

**Symbol Placement Instructions:** The symbol is applied to the geometry of the feature.

**Symbol Type:** Complex

**Repeating Point and Interval:** Component P00038 has an initial offset of 3.2mm; after that 6.4mm.

**Note:** Component P00038 is perpendicular to and on alternating sides of Component L00008. No symbol is portrayed if the Vertical Relative Location [LOC] = Below Ground Surface [40].

<b>Component Ref #:</b>	L00008	<b>Component Type:</b>	Line - Simple	<b>Color Token:</b>	Black
<b>Description:</b>	Black 0.15mm Solid Line				
<b>Parameters:</b>					
<b>Line Weight:</b>	0.15mm				

Component Ref #:	P00038	Component Type:	Point - Simple	Color Token:	Black
Description:	Black 0.75mm length line with a 0.15mm lineweight				
<a href="#">Parameters:</a>					
Line Weight:	0.15mm				
Length:	0.75mm				

### Symbol Rules

Reference #:	Description:	Criteria:
PS-04123	<b>Railway Sidetrack / intact / narrow / non-electrified (line)</b>	Condition of Facility [FUN] = (Fully Functional [6], Unknown [0])
	AND	Railway Gauge Classification [RGC] = (Monorail [6], Narrow [2])
	AND	Railway Power Method [RRA] = (Non-electrified [4], Unknown [0])
	AND	Railway in Road [RIR] = (Separated from Road [1000], Unknown [0])

### Symbol Samples



### Railway Sidetrack / not intact / broad, standard / electrified (line)

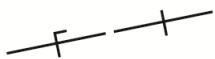

Symbol Graphic

**Symbol Placement Instructions:** The symbol is applied to the geometry of the feature.

**Symbol Type:** Complex

**Repeating Point and Interval:** Component P00280 is centered on the first dash then every other dash of Component L00205.

**Repeating Point and Interval 2:** Component P00044 is centered on the second dash then every other dash of Component L00205.

**Note:** Components P00280 and P00044 are centered perpendicular to Component L00205 with the 0.7mm length line of P00280 on the northernmost side. No symbol is portrayed if the Vertical Relative Location [LOC] = Below Ground Surface [40].

Component Ref #:	L00205	Component Type:	Line - Styled	Color Token:	Black
Description:	Black 0.15mm Dashed Line (0.15mm wt, 5.4mm dash, 1.0mm gap)				
<a href="#">Parameters:</a>					
Line Weight:	0.15mm	Dash Length:	5.4mm	Dash Spacing:	1.0mm
Component Ref #:	P00280	Component Type:	Point - Shape	Color Token:	Black
Description:	Railway tick broad electrified				
<a href="#">Parameters:</a>					
Note:	See Annex H for detailed drawing instructions.				
Component Ref #:	P00044	Component Type:	Point - Simple	Color Token:	Black
Description:	Black 1.5mm length line with a 0.15mm lineweight				
<a href="#">Parameters:</a>					
Line Weight:	0.15mm				
Length:	1.5mm				

### Symbol Rules

Reference #:	Description:	Criteria:
PS-04442	<b>Railway Sidetrack / not intact / broad, standard / electrified (line)</b>	Condition of Facility [FUN] = (Abandoned [2], Damaged [13], Under Construction [1])
	AND	Railway Gauge Classification [RGC] = (Broad [1], Standard [3], Unknown [0])
	AND	Railway Power Method [RRA] = (Electrified Track [1], Overhead Electrified [3])
	AND	Railway in Road [RIR] = (Separated from Road [1000], Unknown [0])

### Symbol Samples

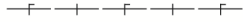

**Railway Sidetrack / not intact / narrow / electrified (line)**



Symbol Graphic

**Symbol Placement Instructions:** The symbol is applied to the geometry of the feature.  
**Symbol Type:** Complex  
**Repeating Point and Interval:** Component P00279 is centered on the first dash then every other dash, on the northernmost side of Component L00205.  
**Repeating Point and Interval 2:** Component P00038 is centered on the second dash then every other dash, on the southernmost side of Component L00205.  
**Note:** Components P00279 and P00038 are perpendicular to and on alternating sides of Component L00205. No symbol is portrayed if the Vertical Relative Location [LOC] = Below Ground Surface [40].

<b>Component Ref #:</b> L00205	<b>Component Type:</b> Line - Styled	<b>Color Token:</b> Black
<b>Description:</b> Black 0.15mm Dashed Line (0.15mm wt, 5.4mm dash, 1.0mm gap)		
<b>Parameters:</b>		
<b>Line Weight:</b> 0.15mm	<b>Dash Length:</b> 5.4mm	<b>Dash Spacing:</b> 1.0mm
<b>Component Ref #:</b> P00279	<b>Component Type:</b> Point - Shape	<b>Color Token:</b> Black
<b>Description:</b> Railway tick narrow electrified		
<b>Parameters:</b>		
<b>Note:</b> See Annex H for detailed drawing instructions.		
<b>Component Ref #:</b> P00038	<b>Component Type:</b> Point - Simple	<b>Color Token:</b> Black
<b>Description:</b> Black 0.75mm length line with a 0.15mm lineweight		
<b>Parameters:</b>		
<b>Line Weight:</b> 0.15mm		
<b>Length:</b> 0.75mm		

**Symbol Rules**

<b>Reference #:</b> PS-04443	<b>Description:</b> Railway Sidetrack / not intact / narrow / electrified (line)	<b>Criteria:</b> Condition of Facility [FUN] = (Abandoned [2], Damaged [13], Under Construction [1])
	AND	Railway Gauge Classification [RGC] = (Monorail [6], Narrow [2])
	AND	Railway Power Method [RRA] = (Electrified Track [1], Overhead Electrified [3])
	AND	Railway in Road [RIR] = (Separated from Road [1000], Unknown [0])

**Symbol Samples**



**Railway Sidetrack / not intact / broad, standard / non-electrified (line)**



Symbol Graphic

**Symbol Placement Instructions:** The symbol is applied to the geometry of the feature.  
**Symbol Type:** Complex  
**Repeating Point and Interval:** Component P00044 is centered on every dash of Component L00205.  
**Note:** Component P00044 is centered perpendicular to Component L00205. No symbol is portrayed if the Vertical Relative Location [LOC] = Below Ground Surface [40].

<b>Component Ref #:</b> L00205	<b>Component Type:</b> Line - Styled	<b>Color Token:</b> Black
<b>Description:</b> Black 0.15mm Dashed Line (0.15mm wt, 5.4mm dash, 1.0mm gap)		
<b>Parameters:</b>		
<b>Line Weight:</b> 0.15mm	<b>Dash Length:</b> 5.4mm	<b>Dash Spacing:</b> 1.0mm



Component Ref #:	P00044	Component Type:	Point - Simple	Color Token:	Black
Description:	Black 1.5mm length line with a 0.15mm lineweight				
<a href="#">Parameters:</a>					
Line Weight:	0.15mm				
Length:	1.5mm				

### Symbol Rules

Reference #:	Description:	Criteria:
PS-04440	<b>Railway Sidetrack / not intact / broad, standard / non-electrified (line)</b>	Condition of Facility [FUN] = (Abandoned [2], Damaged [13], Under Construction [1])
	AND	Railway Gauge Classification [RGC] = (Broad [1], Standard [3], Unknown [0])
	AND	Railway Power Method [RRA] = (Non-electrified [4], Unknown [0])
	AND	Railway in Road [RIR] = (Separated from Road [1000], Unknown [0])

### Symbol Samples



## Railway Sidetrack / not intact / narrow / non-electrified (line)

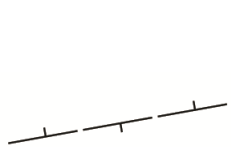

Symbol Graphic

**Symbol Placement Instructions:** The symbol is applied to the geometry of the feature.

**Symbol Type:** Complex

**Repeating Point and Interval:** Component P00038 is centered on every dash of Component L00205.

**Note:** Component P00038 is perpendicular to and on alternating sides of Component L00205. No symbol is portrayed if the Vertical Relative Location [LOC] = Below Ground Surface [40].

Component Ref #:	L00205	Component Type:	Line - Styled	Color Token:	Black
Description:	Black 0.15mm Dashed Line (0.15mm wt, 5.4mm dash, 1.0mm gap)				
<a href="#">Parameters:</a>					
Line Weight:	0.15mm	Dash Length:	5.4mm	Dash Spacing:	1.0mm

Component Ref #:	P00038	Component Type:	Point - Simple	Color Token:	Black
Description:	Black 0.75mm length line with a 0.15mm lineweight				
<a href="#">Parameters:</a>					
Line Weight:	0.15mm				
Length:	0.75mm				

### Symbol Rules

Reference #:	Description:	Criteria:
PS-04441	<b>Railway Sidetrack / not intact / narrow / non-electrified (line)</b>	Condition of Facility [FUN] = (Abandoned [2], Damaged [13], Under Construction [1])
	AND	Railway Gauge Classification [RGC] = (Monorail [6], Narrow [2])
	AND	Railway Power Method [RRA] = (Non-electrified [4], Unknown [0])
	AND	Railway in Road [RIR] = (Separated from Road [1000], Unknown [0])

### Symbol Samples

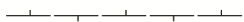

## Railway Sidetrack / intact / railway in road (line)



Symbol Graphic

**Symbol Placement Instructions:** The symbol is applied to the geometry of the feature.

**Symbol Type:** Complex

**Repeating Point and Interval:** Component P00038 has an initial offset of 3.2mm; after that 6.4mm.

**Note:** The symbol is a combination of two lines and one point. Display Level from bottom to top: Component L00232, Component L00231, and Component P00038. Component P00038 is centered on and perpendicular to Component L00232. No symbol is portrayed if the Vertical Relative Location [LOC] = Below Ground Surface [40].

<b>Component Ref #:</b>	L00232	<b>Component Type:</b>	Line - Simple	<b>Color Token:</b>	Black
<b>Description:</b>	Black 0.75mm Solid Line				
<b>Parameters:</b>					
<b>Line Weight:</b>	0.75mm				
<b>Component Ref #:</b>	L00231	<b>Component Type:</b>	Line - Simple	<b>Color Token:</b>	PaperWhite
<b>Description:</b>	PaperWhite 0.45mm Solid Line				
<b>Parameters:</b>					
<b>Line Weight:</b>	0.45mm				
<b>Component Ref #:</b>	P00038	<b>Component Type:</b>	Point - Simple	<b>Color Token:</b>	Black
<b>Description:</b>	Black 0.75mm length line with a 0.15mm lineweight				
<b>Parameters:</b>					
<b>Line Weight:</b>	0.15mm				
<b>Length:</b>	0.75mm				

**Symbol Rules**

<b>Reference #:</b>	<b>Description:</b>	<b>Criteria:</b>
PS-04953	Railway Sidetrack / intact / railway in road (line)	Condition of Facility [FUN] = (Fully Functional [6], Unknown [0])
	AND	Railway in Road [RIR] = In Road [1001]

**Symbol Samples**



**Railway Sidetrack / not intact / railway in road (line)**

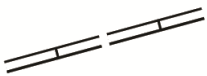

Symbol Graphic

**Symbol Placement Instructions:** The symbol is applied to the geometry of the feature.

**Symbol Type:** Complex

**Repeating Point and Interval:** Component P00038 is centered on every dash of Component L00230.

**Note:** The symbol is a combination of two lines and one point. Display Level from bottom to top: Component L00230, Component L00231, and Component P00038. Component P00038 is perpendicular to Component L00230. No symbol is portrayed if the Vertical Relative Location [LOC] = Below Ground Surface [40].

<b>Component Ref #:</b>	L00230	<b>Component Type:</b>	Line - Styled	<b>Color Token:</b>	Black
<b>Description:</b>	Black 0.75mm Dashed Line (0.75mm wt, 5.9mm dash, 0.5mm gap)				
<b>Parameters:</b>					
<b>Line Weight:</b>	0.75mm	<b>Dash Length:</b>	5.9mm	<b>Dash Spacing:</b>	0.5mm
<b>Component Ref #:</b>	L00231	<b>Component Type:</b>	Line - Simple	<b>Color Token:</b>	PaperWhite
<b>Description:</b>	PaperWhite 0.45mm Solid Line				
<b>Parameters:</b>					
<b>Line Weight:</b>	0.45mm				
<b>Component Ref #:</b>	P00038	<b>Component Type:</b>	Point - Simple	<b>Color Token:</b>	Black
<b>Description:</b>	Black 0.75mm length line with a 0.15mm lineweight				
<b>Parameters:</b>					
<b>Line Weight:</b>	0.15mm				

Length: 0.75mm

Symbol Rules

Reference #:	Description:	Criteria:
PS-04954	Railway Sidetrack / not intact / railway in road (line)	Condition of Facility [FUN] = (Abandoned [2], Damaged [13], Under Construction [1])
	AND	Railway in Road [RIR] = In Road [1001]

Symbol Samples



Railway Sidetrack / dismantled, destroyed (line)

Symbol Graphic

Symbol Placement Instructions: The symbol is applied to the geometry of the feature.

Symbol Type: Simple

Component Ref #:	L00447	Component Type:	Line - Styled	Color Token:	Black
Description:	Black 0.15mm Dashed Line (0.15mm wt, 2.0mm dash, 0.5mm gap)				
<u>Parameters:</u>					
Line Weight:	0.15mm	Dash Length:	2.0mm	Dash Spacing:	0.5mm

Symbol Rules

Reference #:	Description:	Criteria:
PS-04919	Railway Sidetrack / dismantled, destroyed (line)	Condition of Facility [FUN] = (Destroyed [6], Dismantled [5])

Symbol Samples



Railway Turntable (AN075)

Railway Turntable / all (point)

Symbol Graphic

Symbol Placement Instructions: Origin: Center of symbol

Symbol Type: Simple

Component Ref #:	P00238	Component Type:	Point - Shape	Color Token:	Black
Description:	Railway turntable				
<u>Parameters:</u>					
Note:	See Annex H for detailed drawing instructions.				

Symbol Rules

Reference #:	Description:	Criteria:
--------------	--------------	-----------

PS-04127 Railway Turntable / all (point) All

Label Rules

Label Placement Rules (see Annex J): LP-3505, LP-9950, LP-9999

Reference #: Description:

Criteria:

PL-04127\_1 Railway Turntable / not intact (point)

Condition of Facility [FUN] = (Abandoned [2], Damaged [13], Destroyed [3], Dismantled [4], Under Construction [1])

Label String: "[Condition of Facility]"

Characteristics: 28, 28, 28  
28 (Black, Light Condensed, Italic, 6 pt, Lower case)

Symbol Samples

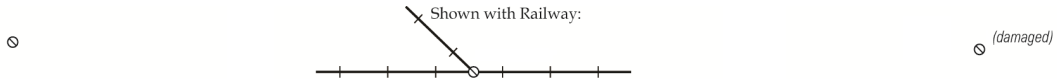

Railway Yard (AN060)

Generalization Rules (see Annex J): GA-9999

Railway Yard / all (area)

Symbol Placement Instructions: Text label only. No graphic parameters

Symbol Type: Simple

[NAM]

Symbol Graphic

Symbol Rules

Reference #: Description:

Criteria:

PS-04126 Railway Yard / all (area)

All

Label Rules

Label Placement Rules (see Annex J): LP-3505, LP-9950, LP-9999

Reference #: Description:

Criteria:

PL-04126\_1 Railway Yard / intact (area)

Condition of Facility [FUN] = (Fully Functional [6], Unknown [0])

Label String: [Name]

Characteristics: 27  
27 (Black, Light Condensed, Italic, 6 pt, Upper case)

PL-04126\_2 Railway Yard / not intact (area)

Condition of Facility [FUN] = (Abandoned [2], Damaged [13], Destroyed [3], Dismantled [4], Under Construction [1])

Label String: [Name] "[Condition of Facility]"

Characteristics: 27, 28, 28, 28  
27 (Black, Light Condensed, Italic, 6 pt, Upper case)  
28 (Black, Light Condensed, Italic, 6 pt, Lower case)

Symbol Samples

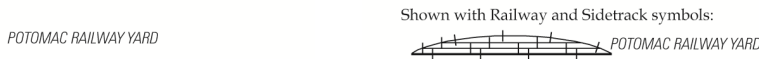

Rapids (BH120)

Generalization Rules (see Annex J): GA-9999, GC-9989, GC-9991

Rapids / all (area)



Symbol Graphic

Symbol Placement Instructions: The symbol is applied to the geometry of the feature.

Symbol Type: Simple

Component Ref #:	A00065	Component Type:	Area - Pattern	Color Token:	Cyan
Description:	Cyan Rapids Pattern				
<a href="#">Parameters:</a>					
Area Pattern:	AP-105, see Annex I				

Symbol Rules

Reference #:	Description:	Criteria:
PS-04197	Rapids / all (area)	All

Label Rules

Label Placement Rules (see Annex J): LP-0050, LP-3506, LP-4813, LP-9999

Reference #:	Description:	Criteria:
PL-04197_1	Rapids / all (area)	N/A

Label String: [Name] "Rapids"  
 Characteristics: 16, 16  
 16 (Cyan, Condensed, Italic, 6 pt, Mixed case)

Symbol Samples



Rapids



Pine Creek Rapids



Shown with River:

Rapids / all (line)



Symbol Graphic

Symbol Placement Instructions: The symbol is applied to the geometry of the feature.

Symbol Type: Compound

Note: The symbol is a combination of two lines. Display Level from bottom to top: Component L00389, Component L00186.

Component Ref #:	L00389	Component Type:	Line - Simple	Color Token:	Cyan
Description:	Cyan 0.9mm Solid Line				
<a href="#">Parameters:</a>					
Line Weight:	0.9mm				

Component Ref #:	L00186	Component Type:	Line - Simple	Color Token:	PaperWhite
Description:	PaperWhite 0.5mm Solid Line				
<a href="#">Parameters:</a>					
Line Weight:	0.5mm				

Symbol Rules

Reference #:	Description:	Criteria:
PS-04198	Rapids / all (line)	All

Label Rules

Label Placement Rules (see Annex J): LP-3505, LP-4813, LP-9999

Reference #:	Description:	Criteria:
PL-04198_1	Rapids / all (line)	N/A

Label String: [Name] "Rapids"  
 Characteristics: 16, 16

16 (Cyan, Condensed, Italic, 6 pt, Mixed case)

Symbol Samples

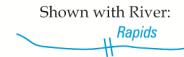

Rapids / all (point)



Symbol Graphic

Symbol Placement Instructions: Origin: Center of symbol

Symbol Type: Simple

Note: The symbol is aligned perpendicular to the associated drainage feature.

Component Ref #:	P00195	Component Type:	Point - Shape	Color Token:	Cyan
Description:	Rapids				
Parameters:					
Note:	See Annex H for detailed drawing instructions.				

Symbol Rules

Reference #:	Description:	Criteria:
PS-04199	Rapids / all (point)	All

Label Rules

Label Placement Rules (see Annex J): LP-3505, LP-4813, LP-9999

Reference #:	Description:	Criteria:
PL-04199_1	Rapids / all (point)	N/A

Label String: [Name] "Rapids"  
 Characteristics: 16, 16  
 16 (Cyan, Condensed, Italic, 6 pt, Mixed case)

Symbol Samples



Recreational Pier (AK190)

Generalization Rules (see Annex J): GA-9999

Recreational Pier / all (area)

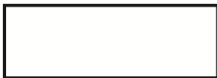

Symbol Graphic

Symbol Placement Instructions: The symbol is applied to the geometry of the feature.

Symbol Type: Simple

Note: This symbol is portrayed in conjunction with the Tidal Water symbol and shall mask out the Tidal Water symbol.

Component Ref #:	L00007	Component Type:	Line - Simple	Color Token:	Black
Description:	Black 0.1mm Solid Line				
Parameters:					
Line Weight:	0.1mm				

Symbol Rules

Reference #: **PS-04063** Description: **Recreational Pier / all (area)** Criteria: **All**

Label Rules

Label Placement Rules (see Annex J): LP-3505, LP-4813, LP-9999

Reference #: **PL-04063\_1** Description: **Recreational Pier / all (area)** Criteria: **N/A**

Label String: [Name] "Pier"  
 Characteristics: 1, 1  
 1 (Black, Condensed, 6 pt, Mixed case)

Symbol Samples

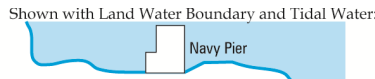
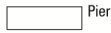

Recreational Pier / all (line)

Symbol Placement Instructions: The symbol is applied to the geometry of the feature.  
 Symbol Type: Simple



Symbol Graphic

Component Ref #: L00009 Component Type: Line - Simple Color Token: Black  
 Description: Black 0.2mm Solid Line  
 Parameters:  
 Line Weight: 0.2mm

Symbol Rules

Reference #: **PS-04064** Description: **Recreational Pier / all (line)** Criteria: **All**

Label Rules

Label Placement Rules (see Annex J): LP-3505, LP-4813, LP-9999

Reference #: **PL-04064\_1** Description: **Recreational Pier / all (line)** Criteria: **N/A**

Label String: [Name] "Pier"  
 Characteristics: 1, 1  
 1 (Black, Condensed, 6 pt, Mixed case)

Symbol Samples



Recycling Site (AB010)

Generalization Rules (see Annex J): GA-9999

Recycling Site / all (area)



Symbol Graphic

**Symbol Placement Instructions:** The symbol is applied to the geometry of the feature.

**Symbol Type:** Simple

<b>Component Ref #:</b>	L00210	<b>Component Type:</b>	Line - Styled	<b>Color Token:</b>	Black
<b>Description:</b>	Black 0.1mm Dashed line (0.1mm wt, 1.0mm dash, 0.5mm gap)				
<u>Parameters:</u>					
<b>Line Weight:</b>	0.1mm	<b>Dash Length:</b>	1.0mm	<b>Dash Spacing:</b>	0.5mm

**Symbol Rules**

<b>Reference #:</b>	<b>Description:</b>	<b>Criteria:</b>
PS-04279	Recycling Site / all (area)	All

**Label Rules**

Label Placement Rules (see Annex J): LP-3506, LP-4813, LP-9950, LP-9999

<b>Reference #:</b>	<b>Description:</b>	<b>Criteria:</b>
PL-04279_1	Recycling Site / intact (area)	Condition of Facility [FUN] = (Fully Functional [6], Unknown [0])

**Label String:** [Name] "Recycling site"  
**Characteristics:** 1, 1  
 1 (Black, Condensed, 6 pt, Mixed case)

<b>Reference #:</b>	<b>Description:</b>	<b>Criteria:</b>
PL-04279_2	Recycling Site / not intact (area)	Condition of Facility [FUN] = (Abandoned [2], Damaged [13], Destroyed [3], Dismantled [4], Under Construction [1])

**Label String:** [Name] "Recycling site" ("[Condition of Facility]")"  
**Characteristics:** 1, 1, 22, 22, 22  
 1 (Black, Condensed, 6 pt, Mixed case)  
 22 (Black, Condensed, 6 pt, Lower case)

**Symbol Samples**



**Reef (BD120)**

Generalization Rules (see Annex J): GA-9999, GC-9997, GC-9999

**Reef / exposed (area)**



Symbol Graphic

**Symbol Placement Instructions:** The symbol is applied to the geometry of the feature.

**Symbol Type:** Complex

**Note:** Component P00207 is applied to the perimeter with a spacing of 0.75mm between origins, and the area is filled with Component A00048. The vertical axis of Component P00207 is perpendicular to the surface delineation and the open end of the symbol faces towards the inside of the Reef area. This symbol is portrayed in conjunction with the Tidal Water symbol and should NOT mask out the Tidal Water symbol. No symbol is portrayed if the Water Level Effect (WLE) = Always Submerged [3].

<b>Component Ref #:</b>	A00048	<b>Component Type:</b>	Area - Fill	<b>Color Token:</b>	Black-12
<b>Description:</b>	Black-12 area fill				
<u>Parameters:</u>					
<b>Screen Angle:</b>	15 degrees	<b>Screen Percent:</b>	12%		

<b>Component Ref #:</b>	P00207	<b>Component Type:</b>	Point - Shape	<b>Color Token:</b>	Black-54
<b>Description:</b>	Reef arc				
<u>Parameters:</u>					



Note: See Annex H for detailed drawing instructions.

**Symbol Rules**

Reference #:	Description:	Criteria:
<b>PS-04663</b>	<b>Reef / exposed (area)</b>	Water Level Effect [WLE] = (Always Dry [2], Covers and Uncovers [4], Floating [8], Not Applicable [998], Other [999], Partly Submerged [1], Unknown [0])

**Label Rules**

Label Placement Rules (see Annex J): LP-0050, LP-3506, LP-9999

Reference #:	Description:	Criteria:
<b>PL-04663_1</b>	<b>Reef / exposed (area)</b>	N/A

Label String: [Name]  
 Characteristics: 12  
 12 (Black, Condensed, Italic 6-16 pt, Upper case)

**Symbol Samples**

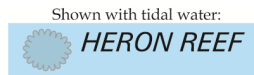

**Reef / exposed (line)**



Symbol Graphic

Symbol Placement Instructions: The symbol is applied to the geometry of the feature.

Symbol Type: Simple

Note: Component P00207 is applied with a spacing of 0.75mm between the origins. The vertical axis of Component P00207 is perpendicular to the curve delineation with the open end of the symbol facing landward. No symbol is portrayed if the Water Level Effect (WLE) = Always Submerged [3].

Component Ref #:	P00207	Component Type:	Point - Shape	Color Token:	Black-54
Description:	Reef arc				
Parameters:					
Note:	See Annex H for detailed drawing instructions.				

**Symbol Rules**

Reference #:	Description:	Criteria:
<b>PS-04662</b>	<b>Reef / exposed (line)</b>	Water Level Effect [WLE] = (Always Dry [2], Covers and Uncovers [4], Floating [8], Not Applicable [998], Other [999], Partly Submerged [1], Unknown [0])

**Label Rules**

Label Placement Rules (see Annex J): LP-0051, LP-3505, LP-9999

Reference #:	Description:	Criteria:
<b>PL-04662_1</b>	<b>Reef / exposed (line)</b>	N/A

Label String: [Name]  
 Characteristics: 6  
 6 (Black, Condensed, Italic 6-9 pt, Mixed case)

**Symbol Samples**

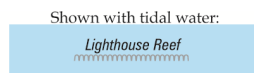

**Reef / exposed (point)**



Symbol Graphic

Symbol Placement Instructions: Origin: Center of symbol

Symbol Type: Simple

Note: No symbol is portrayed if the Water Level Effect (WLE) = Always Submerged [3].

Component Ref #:	P00095	Component Type:	Point - Shape	Color Token:	Black
Description:	Hazardous rock/reef				
<a href="#">Parameters:</a>					
Note:	See Annex H for detailed drawing instructions.				

### Symbol Rules

Reference #:	Description:	Criteria:
PS-04661	Reef / exposed (point)	Water Level Effect [WLE] = (Always Dry [2], Covers and Uncovers [4], Floating [8], Not Applicable [998], Other [999], Partly Submerged [1], Unknown [0])

### Symbol Samples

\*

## Reservoir (BH130)

Generalization Rules (see Annex J): GA-9999

### Reservoir / intact / perennial (area)



Symbol Graphic

Symbol Placement Instructions: The symbol is applied to the geometry of the feature.

Symbol Type: Complex

Note: Component L00007 is applied to the perimeter and is filled with Component A00007.

Component Ref #:	A00007	Component Type:	Area - Fill	Color Token:	Cyan-31
Description:	Cyan-31 area fill				
<a href="#">Parameters:</a>					
Screen Angle:	45 degrees				
Screen Percent:	31%				

Component Ref #:	L00007	Component Type:	Line - Simple	Color Token:	Black
Description:	Black 0.1mm Solid Line				
<a href="#">Parameters:</a>					
Line Weight:	0.1mm				

### Symbol Rules

Reference #:	Description:	Criteria:
PS-04785	Reservoir / intact / perennial (area)	Condition of Facility [FUN] = (Fully Functional [6], Unknown [0]) AND Hydrologic Persistence [HYP] = (Perennial [1], Unknown [0])

### Label Rules

Label Placement Rules (see Annex J): LP-0050, LP-3506, LP-9999

Reference #:	Description:	Criteria:
PL-04785_1	Reservoir / intact / perennial (area)	N/A

Label String: [Name]  
 Characteristics: 5  
 5 (Black, Condensed, Italic, 6 pt, Mixed case)

Symbol Samples



**Reservoir / intact / intermittent, dry (area)**

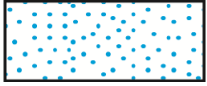

Symbol Graphic

Symbol Placement Instructions: The symbol is applied to the geometry of the feature.

Symbol Type: Complex

Note: Component L00007 is applied to the perimeter and is filled with Component A00020.

Component Ref #:	A00020	Component Type:	Area - Pattern	Color Token:	Cyan
Description:	Cyan Dry Drainage Fill				
Parameters:	<a href="#">Parameters:</a>				
Area Pattern:	AP-95, see Annex I				

Component Ref #:	L00007	Component Type:	Line - Simple	Color Token:	Black
Description:	Black 0.1mm Solid Line				
Parameters:	<a href="#">Parameters:</a>				
Line Weight:	0.1mm				

Symbol Rules

Reference #:	Description:	Criteria:
PS-04786	Reservoir / intact / intermittent, dry (area)	Condition of Facility [FUN] = (Fully Functional [6], Unknown [0])
	AND	Hydrologic Persistence [HYP] = (Dry [4], Intermittent [2])

Label Rules

Label Placement Rules (see Annex J): LP-0050, LP-3506, LP-9999

Reference #:	Description:	Criteria:
PL-04786_1	Reservoir / intact / intermittent, dry (area)	N/A

Label String: [Name]  
 Characteristics: 5  
 5 (Black, Condensed, Italic, 6 pt, Mixed case)

Symbol Samples



**Reservoir / not intact (area)**

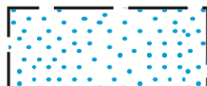

Symbol Graphic

Symbol Placement Instructions: The symbol is applied to the geometry of the feature.

Symbol Type: Complex

Note: Component L00029 is applied to the perimeter and is filled with Component A00020.

Component Ref #:	A00020	Component Type:	Area - Pattern	Color Token:	Cyan
Description:	Cyan Dry Drainage Fill				
Parameters:	<a href="#">Parameters:</a>				
Area Pattern:	AP-95, see Annex I				

Component Ref #: L00029      Component Type: Line - Styled      Color Token: Black  
 Description: Black 0.1mm Dashed Line (0.1mm wt, 2.0mm dash, 0.5mm gap)  
Parameters:  
 Line Weight: 0.1mm      Dash Length: 2.0mm      Dash Spacing: 0.5mm

**Symbol Rules**

Reference #: Description: Criteria:  
**PS-04787**    **Reservoir / not intact (area)**      Condition of Facility [FUN] = (Abandoned [2], Damaged [13], Destroyed [3], Dismantled [4], Under Construction [1])

**Label Rules**

Label Placement Rules (see Annex J): LP-0050, LP-3506, LP-9950, LP-9999

Reference #: Description: Criteria:  
**PL-04787\_1**    **Reservoir / not intact (area)**      Condition of Facility [FUN] = (Abandoned [2], Damaged [13], Destroyed [3], Dismantled [4], Under Construction [1])

Label String: [Name] "["[Condition of Facility]"  
 Characteristics: 5, 35, 35, 35  
 5 (Black, Condensed, Italic, 6 pt, Mixed case)  
 35 (Black, Condensed, Italic, 6 pt, Lower case)

**Symbol Samples**

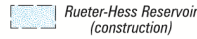

**Rice Field (BH135)**

Generalization Rules (see Annex J): GA-9999

**Rice Field / all (area)**



Symbol Graphic

Symbol Placement Instructions: The symbol is applied to the geometry of the feature.  
 Symbol Type: Simple

Component Ref #: A00019      Component Type: Area - Pattern      Color Token: Cyan  
 Description: Cyan Rice Fill  
Parameters:  
 Area Pattern: AP-4, see Annex I

**Symbol Rules**

Reference #: Description: Criteria:  
**PS-04200**    **Rice Field / all (area)**      All

**Label Rules**

Label Placement Rules (see Annex J): LP-3506

Reference #: Description: Criteria:  
**PL-04200\_1**    **Rice Field / all (area)**      Farming Pattern [FFP] = Terraced [3]

Label String: "Terraces"  
 Characteristics: 1  
 1 (Black, Condensed, 6 pt, Mixed case)

**Symbol Samples**



## Rig (AA040)

### Rig / non-obstruction (point)



Symbol Graphic

Symbol Placement Instructions: Origin: Center of dot

Symbol Type: Simple

Component Ref #:	P00162	Component Type:	Point - Shape	Color Token:	Black
Description:	Rig inland				
Parameters:					
Note:	See Annex H for detailed drawing instructions.				

#### Symbol Rules

Reference #:	Description:	Criteria:
PS-04272	Rig / non-obstruction (point)	Height Above Surface Level [HGT] < 46

#### Label Rules

Label Placement Rules (see Annex J): LP-3505, LP-9999

Reference #:	Description:	Criteria:
PL-04272_1	Rig / non-obstruction (point)	N/A

Label String: [Product]  
 Characteristics: 1  
 1 (Black, Condensed, 6 pt, Mixed case)

#### Symbol Samples



## River (BH140)

Generalization Rules (see Annex J): GA-9999

### River / perennial (area)



Symbol Graphic

Symbol Placement Instructions: The symbol is applied to the geometry of the feature.

Symbol Type: Complex

Note: Component L00015 is applied to the perimeter and is filled with Component A00007.

Component Ref #:	A00007	Component Type:	Area - Fill	Color Token:	Cyan-31
Description:	Cyan-31 area fill				
Parameters:					
Screen Angle:	45 degrees				
Screen Percent:	31%				

Component Ref #: L00015      Component Type: Line - Simple      Color Token: Cyan  
 Description: Cyan 0.2mm Solid Line  
Parameters:  
 Line Weight: 0.2mm

**Symbol Rules**

Reference #: Description: Criteria:  
**PS-04202** River / perennial (area) Hydrologic Persistence [HYP] = (Perennial [1], Unknown [0])

**Label Rules**

Label Placement Rules (see Annex J): LP-0062, LP-9997, LP-9999

Reference #: Description: Criteria:  
**PL-04202\_1** River / perennial (area) N/A

Label String: [Name]  
 Characteristics: 37  
 37 (Cyan, Condensed, Italic, 7-16 pt, Upper case)

**Symbol Samples**



**River / intermittent, dry (area)**

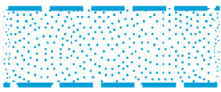

Symbol Graphic

Symbol Placement Instructions: The symbol is applied to the geometry of the feature.

Symbol Type: Complex

Note: Component L00041 is applied to the perimeter and is filled with Component A00020.

Component Ref #: A00020      Component Type: Area - Pattern      Color Token: Cyan  
 Description: Cyan Dry Drainage Fill  
Parameters:  
 Area Pattern: AP-95, see Annex I

Component Ref #: L00041      Component Type: Line - Styled      Color Token: Cyan  
 Description: Cyan 0.2mm Dashed Line (0.2mm wt, 2.0mm dash, 0.5mm gap)  
Parameters:  
 Line Weight: 0.2mm      Dash Length: 2.0mm      Dash Spacing: 0.5mm

**Symbol Rules**

Reference #: Description: Criteria:  
**PS-04203** River / intermittent, dry (area) Hydrologic Persistence [HYP] = (Dry [4], Intermittent [2])

**Label Rules**

Label Placement Rules (see Annex J): LP-0062, LP-9997, LP-9999

Reference #: Description: Criteria:  
**PL-04203\_1** River / intermittent, dry (area) N/A

Label String: [Name]  
 Characteristics: 37  
 37 (Cyan, Condensed, Italic, 7-16 pt, Upper case)

**Symbol Samples**

WHITE RIVER

River / perennial (line)

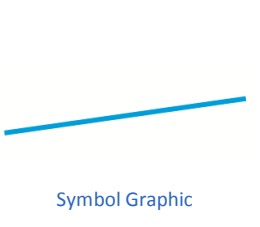

Symbol Placement Instructions: The symbol is applied to the geometry of the feature.

Symbol Type: Simple

Component Ref #:	L00015	Component Type:	Line - Simple	Color Token:	Cyan
Description:	Cyan 0.2mm Solid Line				
Parameters:	Line Weight: 0.2mm				

Symbol Rules

Reference #:	Description:	Criteria:
PS-04204	River / perennial (line)	Hydrologic Persistence [HYP] = (Perennial [1], Unknown [0])

Label Rules

Label Placement Rules (see Annex J): LP-0051, LP-3630, LP-9999

Reference #:	Description:	Criteria:
PL-04204_1	River / perennial (line)	N/A

Label String: [Name]  
 Characteristics: 58  
 58 (Cyan, Condensed, Italic, 7-9 pt, Mixed case)

Symbol Samples



River / intermittent, dry (line)

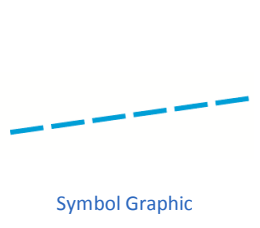

Symbol Placement Instructions: The symbol is applied to the geometry of the feature.

Symbol Type: Simple

Component Ref #:	L00041	Component Type:	Line - Styled	Color Token:	Cyan
Description:	Cyan 0.2mm Dashed Line (0.2mm wt, 2.0mm dash, 0.5mm gap)				
Parameters:	Line Weight: 0.2mm	Dash Length: 2.0mm	Dash Spacing: 0.5mm		

Symbol Rules

Reference #:	Description:	Criteria:
PS-04205	River / intermittent, dry (line)	Hydrologic Persistence [HYP] = (Dry [4], Intermittent [2])

Label Rules

Label Placement Rules (see Annex J): LP-0051, LP-3630, LP-9999

Reference #:	Description:	Criteria:
PL-04205_1	River / intermittent, dry (line)	N/A

Label String: [Name]  
 Characteristics: 58  
 58 (Cyan, Condensed, Italic, 7-9 pt, Mixed case)

Symbol Samples



River Flow Arrow (No Code)

River Flow Arrow (point)



Symbol Graphic

Symbol Placement Instructions: The symbol is manually placed inside surface rivers or parallel to curve rivers. Origin: Center of symbol

Symbol Type: Simple

Note: The arrowhead end of the symbol points in the direction of flow (towards the lower elevation).

Component Ref #:	P00200	Component Type:	Point - Shape	Color Token:	Cyan
Description:	River flow arrow				
Parameters:					
Note:	See Annex H for detailed drawing instructions.				

Symbol Rules

Reference #:	Description:	Criteria:
PS-04649	River Flow Arrow (point)	Portray when the direction of flow is not apparent.

Symbol Samples



Road (AP030)

Generalization Rules (see Annex J): GA-9999

Road / intact / divided / very wide median (line)



Symbol Graphic

Symbol Placement Instructions: The symbol is applied to the geometry of the feature.

Symbol Type: Compound

Note: The symbol is a combination of two lines. Display Level from bottom to top: Component L00153, Component L00105. No symbol is portrayed if the Vertical Relative Location [LOC] = Below Ground Surface [40].

Component Ref #:	L00153	Component Type:	Line - Simple	Color Token:	Black
Description:	Black 0.6mm Solid Line				
Parameters:					
Line Weight:	0.6mm				

Component Ref #:	L00105	Component Type:	Line - Simple	Color Token:	Dk-Brown1815
Description:	Dk-Brown1815 0.3mm Solid Line				
Parameters:					
Line Weight:	0.3mm				



## Symbol Rules

Reference #:	Description:	Criteria:
<b>PS-04877</b>	<b>Road / intact / divided / very wide median (line)</b>	Condition of Facility [FUN] = (Fully Functional [6], Unknown [0])
		AND Divided [SEP] = Present [1001]
		AND Vertical Relative Location [LOC] = (Above Surface [45], On Surface [44], On Waterbody Bottom [17], Unknown [0])
		AND Text [TXT] = Component of Dual Carriageway; traffic flowing in one direction
		AND Distance between the two components of the dual carriageway is >= 75m

## Label Rules

Label Placement Rules (see Annex J): LP-3630, LP-9993, LP-9999

Reference #:	Description:	Criteria:
<b>PL-04877_1</b>	<b>Road / intact / divided / very wide median / &gt; 4 lanes (line)</b>	Track or Lane Count [LTN] > 4 (total of the two corresponding travelled way delineations)
		AND Road Weather Restriction [WTC] = All-weather [1]
	Label String: [Name] [Track or Lane Count] "LANES"	
	Characteristics: 27, 28, 27	
	27 (Black, Light Condensed, Italic, 6 pt, Upper case)	
	28 (Black, Light Condensed, Italic, 6 pt, Lower case)	
<b>PL-04877_2</b>	<b>Road / intact / divided / very wide median / &gt; 4 lanes / closed in winter (line)</b>	Track or Lane Count [LTN] > 4 (total of the two corresponding travelled way delineations)
		AND Road Weather Restriction [WTC] = Closed in Winter [5]
	Label String: [Name] [Track or Lane Count] "LANES CLOSED IN WINTER"	
	Characteristics: 27, 28, 27	
	27 (Black, Light Condensed, Italic, 6 pt, Upper case)	
	28 (Black, Light Condensed, Italic, 6 pt, Lower case)	
<b>PL-04877_3</b>	<b>Road / intact / divided / very wide median / &lt;= 4 lanes (line)</b>	Track or Lane Count [LTN] <= 4 (total of the two corresponding travelled way delineations)
		AND Road Weather Restriction [WTC] = All-weather [1]
	Label String: [Name]	
	Characteristics: 27	
	27 (Black, Light Condensed, Italic, 6 pt, Upper case)	
<b>PL-04877_4</b>	<b>Road / intact / divided / very wide median / &lt;= 4 lanes / closed in winter (line)</b>	Track or Lane Count [LTN] <= 4 (total of the two corresponding travelled way delineations)
		AND Road Weather Restriction [WTC] = Closed in Winter [5]
	Label String: [Name] "CLOSED IN WINTER"	
	Characteristics: 27, 27	
	27 (Black, Light Condensed, Italic, 6 pt, Upper case)	

## Symbol Samples

Shown as both elements of divided Road:  
*EIXO MONUMENTAL 12 LANES*



## Road / intact / divided / wide median (curve)



Symbol Graphic

**Symbol Placement Instructions:** The symbol is applied to a line equidistant between the two extracted traveled ways of the divided road.

**Symbol Type:** Compound

**Note:** The symbol is a combination of four lines. Display Level from bottom to top: Component L00219, Component L00220, Component L00221, Component L00222. No symbol is portrayed if the Vertical Relative Location [LOC] = Below Ground Surface [40].

<b>Component Ref #:</b>	L00219	<b>Component Type:</b>	Line - Simple	<b>Color Token:</b>	Black
<b>Description:</b>	Black 1.45mm Solid Line				
<b>Parameters:</b>					
<b>Line Weight:</b>	1.45mm				
<b>Component Ref #:</b>	L00220	<b>Component Type:</b>	Line - Simple	<b>Color Token:</b>	Dk-Brown1815
<b>Description:</b>	Dk-Brown1815 1.15mm Solid Line				
<b>Parameters:</b>					
<b>Line Weight:</b>	1.15mm				
<b>Component Ref #:</b>	L00221	<b>Component Type:</b>	Line - Simple	<b>Color Token:</b>	Black
<b>Description:</b>	Black 0.55mm Solid Line				
<b>Parameters:</b>					
<b>Line Weight:</b>	0.55mm				
<b>Component Ref #:</b>	L00222	<b>Component Type:</b>	Line - Simple	<b>Color Token:</b>	PaperWhite
<b>Description:</b>	PaperWhite 0.25mm Solid Line				
<b>Parameters:</b>					
<b>Line Weight:</b>	0.25mm				

### Symbol Rules

Reference #:	Description:	Criteria:
<b>PS-04570</b>	<b>Road / intact / divided / wide median (curve)</b>	Condition of Facility [FUN] = (Fully Functional [6], Unknown [0])
		AND Divided [SEP] = Present [1001]
		AND Vertical Relative Location [LOC] = (Above Surface [45], On Surface [44], On Waterbody Bottom [17], Unknown [0])
		AND Text [TXT] = Component of Dual Carriageway; traffic flowing in one direction
		AND Distance between the two components of the dual carriageway is < 75m and >= 50m

### Label Rules

Label Placement Rules (see Annex J): LP-3630, LP-9993, LP-9999

Reference #:	Description:	Criteria:
<b>PL-04570_1</b>	<b>Road / intact / divided / wide median / &gt; 4 lanes (line) (curve)</b>	Track or Lane Count [LTN] > 4 (total of the two corresponding travelled way delineations)
		AND Road Weather Restriction [WTC] = All-weather [1]
	<b>Label String:</b> [Name] [Track or Lane Count] "LANES"	
	<b>Characteristics:</b> 27, 28, 27	
	27 (Black, Light Condensed, Italic, 6 pt, Upper case)	
	28 (Black, Light Condensed, Italic, 6 pt, Lower case)	
<b>PL-04570_2</b>	<b>Road / intact / divided / wide median / &gt; 4 lanes / closed in winter (curve)</b>	Track or Lane Count [LTN] > 4 (total of the two corresponding travelled way delineations)
		AND Road Weather Restriction [WTC] = Closed in Winter [5]
	<b>Label String:</b> [Name] [Track or Lane Count] "LANES CLOSED IN WINTER"	
	<b>Characteristics:</b> 27, 28, 27	
	27 (Black, Light Condensed, Italic, 6 pt, Upper case)	
	28 (Black, Light Condensed, Italic, 6 pt, Lower case)	
<b>PL-04570_3</b>	<b>Road / intact / divided / wide median / &lt;= 4 lanes (curve)</b>	Track or Lane Count [LTN] <= 4 (total of the two corresponding travelled way delineations)

AND Road Weather Restriction [WTC] = All-weather [1]

Label String: [Name]

Characteristics: 27  
27 (Black, Light Condensed, Italic, 6 pt, Upper case)

**PL-04570\_4 Road / intact / divided / wide median / <= 4 lanes / closed in winter (curve)**

Track or Lane Count [LTN] <= 4 (total of the two corresponding travelled way delineations)

AND Road Weather Restriction [WTC] = Closed in Winter [5]

Label String: [Name] "CLOSED IN WINTER"

Characteristics: 27, 27  
27 (Black, Light Condensed, Italic, 6 pt, Upper case)

Symbol Samples



Road / intact / divided / narrow median (line)



Symbol Graphic

Symbol Placement Instructions: The symbol is applied to a line equidistant between the two extracted traveled ways of the divided road.

Symbol Type: Compound

Note: The symbol is a combination of three lines. Display Level from bottom to top: Component L00430, Component L00431, Component L00007. No symbol is portrayed if the Vertical Relative Location [LOC] = Below Ground Surface [40].

Component Ref #:	L00430	Component Type:	Line - Simple	Color Token:	Black
Description:	Black 1.1mm Solid Line				
Parameters:					
Line Weight:	1.1mm				
Component Ref #:	L00431	Component Type:	Line - Simple	Color Token:	Dk-Brown1815
Description:	Dk-Brown1815 0.8mm Solid Line				
Parameters:					
Line Weight:	0.8mm				
Component Ref #:	L00007	Component Type:	Line - Simple	Color Token:	Black
Description:	Black 0.1mm Solid Line				
Parameters:					
Line Weight:	0.1mm				

Symbol Rules

Reference #:	Description:	Criteria:
PS-04369	Road / intact / divided / narrow median (line)	Condition of Facility [FUN] = (Fully Functional [6], Unknown [0])
		AND Divided [SEP] = Present [1001]
		AND Vertical Relative Location [LOC] = (Above Surface [45], On Surface [44], On Waterbody Bottom [17], Unknown [0])
		AND Text [TXT] = Component of Dual Carriageway; traffic flowing in one direction
		AND Distance between the two components of the dual carriageway is < 50m

Label Rules

Label Placement Rules (see Annex J): LP-3630, LP-9993, LP-9999

Reference #:	Description:	Criteria:
PL-04369_1	Road / intact / divided / narrow median / > 4 lanes / (curve)	Track or Lane Count [LTN] > 4 (total of the two corresponding travelled way delineations)

AND Road Weather Restriction [WTC] = All-weather [1]

Label String: [Name] [Track or Lane Count] "LANES"  
 Characteristics: 27, 28, 27  
 27 (Black, Light Condensed, Italic, 6 pt, Upper case)  
 28 (Black, Light Condensed, Italic, 6 pt, Lower case)

**PL-04369\_2 Road / intact / divided / narrow median / > 4 lanes / closed in winter (line)** Track or Lane Count [LTN] > 4 (total of the two corresponding travelled way delineations)

AND Road Weather Restriction [WTC] = Closed in Winter [5]

Label String: [Name] [Track or Lane Count] "LANES CLOSED IN WINTER"  
 Characteristics: 27, 28, 27  
 27 (Black, Light Condensed, Italic, 6 pt, Upper case)  
 28 (Black, Light Condensed, Italic, 6 pt, Lower case)

**PL-04369\_3 Road / intact / divided / narrow median / <= 4 lanes (line)** Track or Lane Count [LTN] <= 4 (total of the two corresponding travelled way delineations)

AND Road Weather Restriction [WTC] = All-weather [1]

Label String: [Name]  
 Characteristics: 27  
 27 (Black, Light Condensed, Italic, 6 pt, Upper case)

**PL-04369\_4 Road / intact / divided / narrow median / <= 4 lanes / closed in winter (line)** Track or Lane Count [LTN] <= 4 (total of the two corresponding travelled way delineations)

AND Road Weather Restriction [WTC] = Closed in Winter [5]

Label String: [Name] "CLOSED IN WINTER"  
 Characteristics: 27, 27  
 27 (Black, Light Condensed, Italic, 6 pt, Upper case)

Symbol Samples



6 LANES



WASHINGTON 6 LANES



Road / intact / all weather / hard surface / no median / >= 4 lanes / primary (line)



Symbol Graphic

Symbol Placement Instructions: The symbol is applied to the geometry of the feature.

Symbol Type: Compound

Note: The symbol is a combination of two lines. Display Level from bottom to top: Component L00433, Component L00159. No symbol is portrayed if the Vertical Relative Location [LOC] = Below Ground Surface [40].

Component Ref #:	L00433	Component Type:	Line - Simple	Color Token:	Black
Description:	Black 0.9mm Solid Line				
Parameters:					
Line Weight:	0.9mm				

Component Ref #:	L00159	Component Type:	Line - Simple	Color Token:	Dk-Brown1815
Description:	Dk-Brown1815 0.6mm Solid Line				
Parameters:					
Line Weight:	0.6mm				

Symbol Rules

Reference #:	Description:	Criteria:
PS-04368	Road / intact / all weather / hard surface / no median / >= 4 lanes / primary (line)	Condition of Facility [FUN] = (Fully Functional [6], Unknown [0])

AND Road Weather Restriction [WTC] = (All-weather [1], Closed in Winter [5])

- AND Load-bearing Surface Type [RST] = Hard/Paved [1]
- AND Divided [SEP] = (False [1000], Unknown [0])
- AND Track or Lane Count [LTN] >= 4
- AND Vertical Relative Location [LOC] = (Above Surface [45], On Surface [44], On Waterbody Bottom [17], Unknown [0])
- AND Thoroughfare Class [HCT] = (National Motorway [3], Primary Route [1], Unknown [0])

**Label Rules**

Label Placement Rules (see Annex J): LP-3630, LP-9999

Reference #:	Description:	Criteria:
PL-04368_1	Road / intact / all weather / hard surface / no median / > 4 lanes / primary (line)	Track or Lane Count [LTN] > 4
		AND Road Weather Restriction [WTC] = All-weather [1]
	Label String: [Name] [Track or Lane Count] "LANES"	
	Characteristics: 27, 28, 27 27 (Black, Light Condensed, Italic, 6 pt, Upper case) 28 (Black, Light Condensed, Italic, 6 pt, Lower case)	
PL-04368_2	Road / intact / all weather / hard surface / no median / > 4 lanes / primary / closed in winter (line)	Track or Lane Count [LTN] > 4
		AND Road Weather Restriction [WTC] = Closed in Winter [5]
	Label String: [Name] [Track or Lane Count] "LANES CLOSED IN WINTER"	
	Characteristics: 27, 28, 27 27 (Black, Light Condensed, Italic, 6 pt, Upper case) 28 (Black, Light Condensed, Italic, 6 pt, Lower case)	
PL-04368_3	Road / intact / all weather / hard surface / no median / 4 lanes / primary (line)	Track or Lane Count [LTN] = 4
		AND Road Weather Restriction [WTC] = All-weather [1]
	Label String: [Name]	
	Characteristics: 27 27 (Black, Light Condensed, Italic, 6 pt, Upper case)	
PL-04368_4	Road / intact / all weather / hard surface / no median / 4 lanes / primary / closed in winter (line)	Track or Lane Count [LTN] = 4
		AND Road Weather Restriction [WTC] = Closed in Winter [5]
	Label String: [Name] "CLOSED IN WINTER"	
	Characteristics: 27, 27 27 (Black, Light Condensed, Italic, 6 pt, Upper case)	

**Symbol Samples**



6 LANES



FRANKLIN 6 LANES



**Road / intact / all weather / hard surface / no median / >= 4 lanes / secondary (line)**

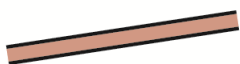

Symbol Graphic

Symbol Placement Instructions: The symbol is applied to the geometry of the feature.

Symbol Type: Compound

Note: The symbol is a combination of two lines. Display Level from bottom to top: Component L00433, Component L00374. No symbol is portrayed if the Vertical Relative Location [LOC] = Below Ground Surface [40].

Component Ref #: L00433      Component Type: Line - Simple      Color Token: Black  
 Description: Black 0.9mm Solid Line  
[Parameters:](#)  
 Line Weight: 0.9mm

Component Ref #: L00374      Component Type: Line - Simple      Color Token: Dk-Brown1815-54  
 Description: Dk-Brown1815-54 0.6mm Screened Line  
[Parameters:](#)  
 Line Weight: 0.6mm  
 Screen Angle: 45 degrees  
 Screen Percent: 54%

**Symbol Rules**

Reference #:	Description:	Criteria:
<b>PS-04373</b>	<b>Road / intact / all weather / hard surface / no median / &gt;= 4 lanes / secondary (line)</b>	Condition of Facility [FUN] = (Fully Functional [6], Unknown [0])
	AND	Road Weather Restriction [WTC] = (All-weather [1], Closed in Winter [5])
	AND	Load-bearing Surface Type [RST] = Hard/Paved [1]
	AND	Divided [SEP] = (False [1000], Unknown [0])
	AND	Track or Lane Count [LTN] >= 4
	AND	Vertical Relative Location [LOC] = (Above Surface [45], On Surface [44], On Waterbody Bottom [17], Unknown [0])
	AND	Thoroughfare Class [HCT] = (Local Route [4], Secondary Route [2])

**Label Rules**

Label Placement Rules (see Annex J): LP-3630, LP-9999

Reference #:	Description:	Criteria:
<b>PL-04373_1</b>	<b>Road / intact / all weather / hard surface / no median / &gt; 4 lanes / secondary (line)</b>	Track or Lane Count [LTN] > 4
	AND	Road Weather Restriction [WTC] = All-weather [1]
	Label String:	[Name] [Track or Lane Count] "LANES"
	Characteristics:	27, 28, 27 27 (Black, Light Condensed, Italic, 6 pt, Upper case) 28 (Black, Light Condensed, Italic, 6 pt, Lower case)
<b>PL-04373_2</b>	<b>Road / intact / all weather / hard surface / no median / &gt; 4 lanes / secondary / closed in winter (line)</b>	Track or Lane Count [LTN] > 4
	AND	Road Weather Restriction [WTC] = Closed in Winter [5]
	Label String:	[Name] [Track or Lane Count] "LANES CLOSED IN WINTER"
	Characteristics:	27, 28, 27 27 (Black, Light Condensed, Italic, 6 pt, Upper case) 28 (Black, Light Condensed, Italic, 6 pt, Lower case)
<b>PL-04373_3</b>	<b>Road / intact / all weather / hard surface / no median / 4 lanes / secondary (line)</b>	Track or Lane Count [LTN] <= 4
	AND	Road Weather Restriction [WTC] = All-weather [1]
	Label String:	[Name]
	Characteristics:	27 27 (Black, Light Condensed, Italic, 6 pt, Upper case)
<b>PL-04373_4</b>	<b>Road / intact / all weather / hard surface / no median / 4 lanes / secondary / closed in winter (line)</b>	Track or Lane Count [LTN] <= 4
	AND	Road Weather Restriction [WTC] = Closed in Winter [5]
	Label String:	[Name] "CLOSED IN WINTER"
	Characteristics:	27, 27 27 (Black, Light Condensed, Italic, 6 pt, Upper case)

**Symbol Samples**

**Road / intact / all weather / hard surface / no median / 2 or 3 lanes / primary (line)**

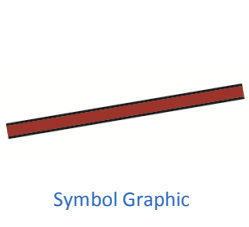

**Symbol Placement Instructions:** The symbol is applied to the geometry of the feature.

**Symbol Type:** Compound

**Note:** The symbol is a combination of two lines. Display Level from bottom to top: Component L00426, Component L00156. No symbol is portrayed if the Vertical Relative Location [LOC] = Below Ground Surface [40].

**Component Ref #:** L00426      **Component Type:** Line - Simple      **Color Token:** Black  
**Description:** Black 0.7mm Solid Line  
**Parameters:**  
**Line Weight:** 0.7mm

**Component Ref #:** L00156      **Component Type:** Line - Simple      **Color Token:** Dk-Brown1815  
**Description:** Dk-Brown1815 0.5mm Solid Line  
**Parameters:**  
**Line Weight:** 0.5mm

**Symbol Rules**

Reference #:	Description:	Criteria:
<b>PS-04720</b>	<b>Road / intact / all weather / hard surface / no median / 2 or 3 lanes / primary (line)</b>	Condition of Facility [FUN] = (Fully Functional [6], Unknown [0])
	AND	Road Weather Restriction [WTC] = (All-weather [1], Closed in Winter [5])
	AND	Load-bearing Surface Type [RST] = Hard/Paved [1]
	AND	Divided [SEP] = (False [1000], Unknown [0])
	AND	Track or Lane Count [LTN] = (2, 3)
	AND	Vertical Relative Location [LOC] = (Above Surface [45], On Surface [44], On Waterbody Bottom [17], Unknown [0])
	AND	Thoroughfare Class [HCT] = (National Motorway [3], Primary Route [1], Unknown [0])

**Label Rules**

**Label Placement Rules (see Annex J):** LP-3630, LP-9999

Reference #:	Description:	Criteria:
<b>PL-04720_1</b>	<b>Road / intact / all weather / hard surface / no median / 2 lanes / primary (line)</b>	Track or Lane Count [LTN] = 2
	AND	Road Weather Restriction [WTC] = All-weather [1]
	<b>Label String:</b> [Name]	
	<b>Characteristics:</b> 27 27 (Black, Light Condensed, Italic, 6 pt, Upper case)	
<b>PL-04720_2</b>	<b>Road / intact / all weather / hard surface / no median / 2 lanes / primary / closed in winter (line)</b>	Track or Lane Count [LTN] = 2
	AND	Road Weather Restriction [WTC] = Closed in Winter [5]
	<b>Label String:</b> [Name] "CLOSED IN WINTER"	
	<b>Characteristics:</b> 27, 27 27 (Black, Light Condensed, Italic, 6 pt, Upper case)	
<b>PL-04720_3</b>	<b>Road / intact / all weather / hard surface / no median / 3 lanes / primary (line)</b>	Track or Lane Count [LTN] = 3

AND Road Weather Restriction [WTC] = All-weather [1]

Label String: [Name] "3 LANES"

Characteristics: 27, 27  
27 (Black, Light Condensed, Italic, 6 pt, Upper case)

**PL-04720\_4 Road / intact / all weather / hard surface / no median / 3 lanes / primary / closed in winter (line)** Track or Lane Count [LTN] = 3

AND Road Weather Restriction [WTC] = Closed in Winter [5]

Label String: [Name] "3 LANES CLOSED IN WINTER"

Characteristics: 27, 27  
27 (Black, Light Condensed, Italic, 6 pt, Upper case)

Symbol Samples

ATCHISON

**Road / intact / all weather / hard surface / no median / 2 or 3 lanes / secondary (line)**

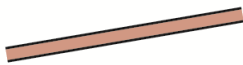

Symbol Graphic

Symbol Placement Instructions: The symbol is applied to the geometry of the feature.

Symbol Type: Compound

Note: The symbol is a combination of two lines. Display Level from bottom to top: Component L00426, Component L00376. No symbol is portrayed if the Vertical Relative Location [LOC] = Below Ground Surface [40].

Component Ref #: L00426      Component Type: Line - Simple      Color Token: Black  
Description: Black 0.7mm Solid Line  
[Parameters:](#)  
Line Weight: 0.7mm

Component Ref #: L00376      Component Type: Line - Simple      Color Token: Dk-Brown1815-54  
Description: Dk-Brown1815-54 0.5mm Screened Line  
[Parameters:](#)  
Line Weight: 0.5mm  
Screen Angle: 45 degrees  
Screen Percent: 54%

Symbol Rules

<p>Reference #: <b>PS-04722</b></p> <p>Description: <b>Road / intact / all weather / hard surface / no median / 2 or 3 lanes / secondary (line)</b></p>	<p>Criteria:</p> <p>Condition of Facility [FUN] = (Fully Functional [6], Unknown [0])</p> <p>AND Road Weather Restriction [WTC] = (All-weather [1], Closed in Winter [5])</p> <p>AND Load-bearing Surface Type [RST] = Hard/Paved [1]</p> <p>AND Divided [SEP] = (False [1000], Unknown [0])</p> <p>AND Track or Lane Count [LTN] = (2, 3)</p> <p>AND Vertical Relative Location [LOC] = (Above Surface [45], On Surface [44], On Waterbody Bottom [17], Unknown [0])</p> <p>AND Thoroughfare Class [HCT] = (Local Route [4], Secondary Route [2])</p>
---	--

Label Rules

Label Placement Rules (see Annex J): LP-3630, LP-9999

<p>Reference #: <b>PL-04722_1</b></p> <p>Description: <b>Road / intact / all weather / hard surface / no median / 2 lanes / secondary (line)</b></p>	<p>Criteria:</p> <p>Track or Lane Count [LTN] = 2</p>
--	---



AND Road Weather Restriction [WTC] = All-weather [1]

Label String: [Name]  
 Characteristics: 27  
 27 (Black, Light Condensed, Italic, 6 pt, Upper case)

**PL-04722\_2 Road / intact / all weather / hard surface / no median / 2 lanes / secondary / closed in winter (line)** Track or Lane Count [LTN] = 2

AND Road Weather Restriction [WTC] = Closed in Winter [5]

Label String: [Name] "CLOSED IN WINTER"  
 Characteristics: 27, 27  
 27 (Black, Light Condensed, Italic, 6 pt, Upper case)

**PL-04722\_3 Road / intact / all weather / hard surface / no median / 3 lanes / secondary (line)** Track or Lane Count [LTN] = 3

AND Road Weather Restriction [WTC] = All-weather [1]

Label String: [Name] "3 LANES"  
 Characteristics: 27, 27  
 27 (Black, Light Condensed, Italic, 6 pt, Upper case)

**PL-04722\_4 Road / intact / all weather / hard surface / no median / 3 lanes / secondary / closed in winter (line)** Track or Lane Count [LTN] = 3

AND Road Weather Restriction [WTC] = Closed in Winter [5]

Label String: [Name] "3 LANES CLOSED IN WINTER"  
 Characteristics: 27, 27  
 27 (Black, Light Condensed, Italic, 6 pt, Upper case)

Symbol Samples

HUGHES

**Road / intact / all weather / hard surface / no median / 1 lane / primary (line)**



Symbol Graphic

Symbol Placement Instructions: The symbol is applied to the geometry of the feature.

Symbol Type: Compound

Note: The symbol is a combination of two lines. Display Level from bottom to top: Component L00014, Component L00105. No symbol is portrayed if the Vertical Relative Location [LOC] = Below Ground Surface [40].

Component Ref #:	L00014	Component Type:	Line - Simple	Color Token:	Black
Description:	Black 0.5mm Solid Line				
Parameters:					
Line Weight:	0.5mm				

Component Ref #:	L00105	Component Type:	Line - Simple	Color Token:	Dk-Brown1815
Description:	Dk-Brown1815 0.3mm Solid Line				
Parameters:					
Line Weight:	0.3mm				

Symbol Rules

Reference #:	Description:	Criteria:
<b>PS-04367</b>	<b>Road / intact / all weather / hard surface / no median / 1 lane / primary (line)</b>	Condition of Facility [FUN] = (Fully Functional [6], Unknown [0])
		AND Road Weather Restriction [WTC] = (All-weather [1], Closed in Winter [5])
		AND Load-bearing Surface Type [RST] = Hard/Paved [1])

- AND Divided [SEP] = (False [1000], Unknown [0])
- AND Track or Lane Count [LTN] <= 1
- AND Vertical Relative Location [LOC] = (Above Surface [45], On Surface [44], On Waterbody Bottom [17], Unknown [0])
- AND Thoroughfare Class [HCT] = (National Motorway [3], Primary Route [1], Unknown [0])

**Label Rules**

Label Placement Rules (see Annex J): LP-3630, LP-9999

Reference #:	Description:	Criteria:
<b>PL-04367_1</b>	<b>Road / intact / all weather / hard surface / no median / 1 lane / primary (line)</b>	Road Weather Restriction [WTC] = All-weather [1]
	Label String: [Name]	
	Characteristics: 27	
	27 (Black, Light Condensed, Italic, 6 pt, Upper case)	
<b>PL-04367_2</b>	<b>Road / intact / all weather / hard surface / no median / 1 lane / primary / closed in winter (line)</b>	Road Weather Restriction [WTC] = Closed in Winter [5]
	Label String: [Name] "CLOSED IN WINTER"	
	Characteristics: 27, 27	
	27 (Black, Light Condensed, Italic, 6 pt, Upper case)	

**Symbol Samples**

*MAPLE*

**Road / intact / all weather / hard surface / no median / 1 lane / secondary (line)**

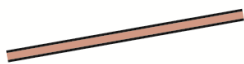

Symbol Graphic

Symbol Placement Instructions: The symbol is applied to the geometry of the feature.

Symbol Type: Compound

Note: The symbol is a combination of two lines. Display Level from bottom to top: Component L00014, Component L00387. No symbol is portrayed if the Vertical Relative Location [LOC] = Below Ground Surface [40].

Component Ref #:	L00014	Component Type:	Line - Simple	Color Token:	Black
Description:	Black 0.5mm Solid Line				
Parameters:					
Line Weight:	0.5mm				
Component Ref #:	L00387	Component Type:	Line - Simple	Color Token:	Dk-Brown1815-54
Description:	Dk-Brown1815-54 0.3mm Screened Line				
Parameters:					
Line Weight:	0.3mm				
Screen Angle:	45 degrees				
Screen Percent:	54%				

**Symbol Rules**

Reference #:	Description:	Criteria:
<b>PS-04372</b>	<b>Road / intact / all weather / hard surface / no median / 1 lane / secondary (line)</b>	Condition of Facility [FUN] = (Fully Functional [6], Unknown [0])
		AND Road Weather Restriction [WTC] = (All-weather [1], Closed in Winter [5])
		AND Load-bearing Surface Type [RST] = Hard/Paved [1]
		AND Divided [SEP] = (False [1000], Unknown [0])
		AND Track or Lane Count [LTN] <= 1
		AND Vertical Relative Location [LOC] = (Above Surface [45], On Surface [44], On Waterbody Bottom [17], Unknown [0])
		AND Thoroughfare Class [HCT] = (Local Route [4], Secondary Route [2])

Label Rules

Label Placement Rules (see Annex J): LP-3630, LP-9999

Reference #:	Description:	Criteria:
<b>PL-04372_1</b>	<b>Road / intact / all weather / hard surface / no median / 1 lane / secondary (line)</b>	Road Weather Restriction [WTC] = All-weather [1]
	Label String: [Name]	
	Characteristics: 27 27 (Black, Light Condensed, Italic, 6 pt, Upper case)	
<b>PL-04372_2</b>	<b>Road / intact / all weather / hard surface / no median / 1 lane / secondary / closed in winter (line)</b>	Road Weather Restriction [WTC] = Closed in Winter [5]
	Label String: [Name] "CLOSED IN WINTER"	
	Characteristics: 27, 27 27 (Black, Light Condensed, Italic, 6 pt, Upper case)	

Symbol Samples

VALLEY VIEW

Road / intact / all weather / loose surface / no median / >= 4 lanes / primary (line)



Symbol Graphic

Symbol Placement Instructions: The symbol is applied to the geometry of the feature.

Symbol Type: Compound

Note: The symbol is a combination of three lines. Display Level from bottom to top: Component L00433, Component L00182, Component L00169. No symbol is portrayed if the Vertical Relative Location [LOC] = Below Ground Surface [40].

Component Ref #:	L00433	Component Type:	Line - Simple	Color Token:	Black
Description:	Black 0.9mm Solid Line				
Parameters:					
Line Weight:	0.9mm				
Component Ref #:	L00182	Component Type:	Line - Simple	Color Token:	PaperWhite
Description:	PaperWhite 0.6mm Solid Line				
Parameters:					
Line Weight:	0.6mm				
Component Ref #:	L00169	Component Type:	Line - Styled	Color Token:	Dk-Brown1815
Description:	Dk-Brown1815 0.6mm Dashed Line (0.6mm wt, 3.5mm dash, 1.5mm gap)				
Parameters:					
Line Weight:	0.6mm	Dash Length:	3.5mm	Dash Spacing:	1.5mm

Symbol Rules

Reference #:	Description:	Criteria:
<b>PS-04371</b>	<b>Road / intact / all weather / loose surface / no median / &gt;= 4 lanes / primary (line)</b>	Condition of Facility [FUN] = (Fully Functional [6], Unknown [0])
	AND	Road Weather Restriction [WTC] = (All-weather [1], Closed in Winter [5])
	AND	Load-bearing Surface Type [RST] = (Loose/Unpaved [2], Temporary [8], Unknown [0])
	AND	Divided [SEP] = (False [1000], Unknown [0])
	AND	Track or Lane Count [LTN] >= 4
	AND	Vertical Relative Location [LOC] = (Above Surface [45], On Surface [44], On Waterbody Bottom [17], Unknown [0])
	AND	Thoroughfare Class [HCT] = (National Motorway [3], Primary Route [1], Unknown [0])

Label Rules

Label Placement Rules (see Annex J): LP-3630, LP-9999

Reference #:	Description:	Criteria:
--------------	--------------	-----------

**PL-04371\_1** Road / intact / all weather / loose surface / no median / > 4 lanes / primary (line)

Track or Lane Count [LTN] > 4

AND Road Weather Restriction [WTC] = All-weather [1]

Label String: [Name] [Track or Lane Count] "LANES"

Characteristics: 27, 28, 27  
 27 (Black, Light Condensed, Italic, 6 pt, Upper case)  
 28 (Black, Light Condensed, Italic, 6 pt, Lower case)

**PL-04371\_2** Road / intact / all weather / loose surface / no median / > 4 lanes / primary / closed in winter (line)

Track or Lane Count [LTN] > 4

AND Road Weather Restriction [WTC] = Closed in Winter [5]

Label String: [Name] [Track or Lane Count] "LANES CLOSED IN WINTER"

Characteristics: 27, 28, 27  
 27 (Black, Light Condensed, Italic, 6 pt, Upper case)  
 28 (Black, Light Condensed, Italic, 6 pt, Lower case)

**PL-04371\_3** Road / intact / all weather / loose surface / no median / 4 lanes / primary (line)

Track or Lane Count [LTN] = 4

AND Road Weather Restriction [WTC] = All-weather [1]

Label String: [Name]

Characteristics: 27  
 27 (Black, Light Condensed, Italic, 6 pt, Upper case)

**PL-04371\_4** Road / intact / all weather / loose surface / no median / 4 lanes / primary / closed in winter (line)

Track or Lane Count [LTN] = 4

AND Road Weather Restriction [WTC] = Closed in Winter [5]

Label String: [Name] "CLOSED IN WINTER"

Characteristics: 27, 27  
 27 (Black, Light Condensed, Italic, 6 pt, Upper case)

Symbol Samples



Road / intact / all weather / loose surface / no median / >= 4 lanes / secondary (line)

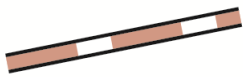

Symbol Graphic

Symbol Placement Instructions: The symbol is applied to the geometry of the feature.

Symbol Type: Compound

Note: The symbol is a combination of three lines. Display Level from bottom to top: Component L00433, Component L00182, Component L00436. No symbol is portrayed if the Vertical Relative Location [LOC] = Below Ground Surface [40].

Component Ref #:	L00433	Component Type:	Line - Simple	Color Token:	Black
Description:	Black 0.9mm Solid Line				
Parameters:					
Line Weight:	0.9mm				
Component Ref #:	L00182	Component Type:	Line - Simple	Color Token:	PaperWhite
Description:	PaperWhite 0.6mm Solid Line				
Parameters:					
Line Weight:	0.6mm				
Component Ref #:	L00436	Component Type:	Line - Styled	Color Token:	Dk-Brown1815-54
Description:	Dk-Brown1815-54 0.6mm Screened Dashed Line (0.6mm wt, 3.5mm, 1.5mm gap)				
Parameters:					

Line Weight: 0.6mm      Dash Length: 3.5mm      Dash Spacing: 1.5mm  
 Screen Angle: 45 degrees  
 Screen Percent: 54%

**Symbol Rules**

Reference #:	Description:	Criteria:
<b>PS-04376</b>	<b>Road / intact / all weather / loose surface / no median / &gt;= 4 lanes / secondary (line)</b>	Condition of Facility [FUN] = (Fully Functional [6], Unknown [0])
	AND	Road Weather Restriction [WTC] = (All-weather [1], Closed in Winter [5])
	AND	Load-bearing Surface Type [RST] = (Loose/Unpaved [2], Temporary [8], Unknown [0])
	AND	Divided [SEP] = (False [1000], Unknown [0])
	AND	Track or Lane Count [LTN] >= 4
	AND	Vertical Relative Location [LOC] = (Above Surface [45], On Surface [44], On Waterbody Bottom [17], Unknown [0])
	AND	Thoroughfare Class [HCT] = (Local Route [4], Secondary Route [2])

**Label Rules**

Label Placement Rules (see Annex J): LP-3630, LP-9999

Reference #:	Description:	Criteria:
<b>PL-04376_1</b>	<b>Road / intact / all weather / loose surface / no median / &gt; 4 lanes / secondary (line)</b>	Track or Lane Count [LTN] > 4
	AND	Road Weather Restriction [WTC] = All-weather [1]
	Label String:	[Name] [Track or Lane Count] "LANES"
	Characteristics:	27, 28, 27 27 (Black, Light Condensed, Italic, 6 pt, Upper case) 28 (Black, Light Condensed, Italic, 6 pt, Lower case)
<b>PL-04376_2</b>	<b>Road / intact / all weather / loose surface / no median / &gt; 4 lanes / secondary / closed in winter (line)</b>	Track or Lane Count [LTN] > 4
	AND	Road Weather Restriction [WTC] = Closed in Winter [5]
	Label String:	[Name] [Track or Lane Count] "LANES CLOSED IN WINTER"
	Characteristics:	27, 28, 27 27 (Black, Light Condensed, Italic, 6 pt, Upper case) 28 (Black, Light Condensed, Italic, 6 pt, Lower case)
<b>PL-04376_3</b>	<b>Road / intact / all weather / loose surface / no median / 4 lanes / secondary (line)</b>	Track or Lane Count [LTN] <= 4
	AND	Road Weather Restriction [WTC] = All-weather [1]
	Label String:	[Name]
	Characteristics:	27 27 (Black, Light Condensed, Italic, 6 pt, Upper case)
<b>PL-04376_4</b>	<b>Road / intact / all weather / loose surface / no median / 4 lanes / secondary / closed in winter (line)</b>	Track or Lane Count [LTN] <= 4
	AND	Road Weather Restriction [WTC] = Closed in Winter [5]
	Label String:	[Name] "CLOSED IN WINTER"
	Characteristics:	27, 27 27 (Black, Light Condensed, Italic, 6 pt, Upper case)

**Symbol Samples**



**Road / intact / all weather / loose surface / no median / 2 or 3 lanes / primary (line)**

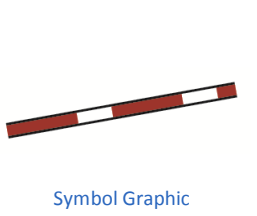

**Symbol Placement Instructions:** The symbol is applied to the geometry of the feature.

**Symbol Type:** Compound

**Note:** The symbol is a combination of three lines. Display Level from bottom to top: Component L00426, Component L00186, Component L00192. No symbol is portrayed if the Vertical Relative Location [LOC] = Below Ground Surface [40].

<b>Component Ref #:</b> L00426	<b>Component Type:</b> Line - Simple	<b>Color Token:</b> Black
<b>Description:</b> Black 0.7mm Solid Line		
<u>Parameters:</u>		
<b>Line Weight:</b> 0.7mm		
<b>Component Ref #:</b> L00186	<b>Component Type:</b> Line - Simple	<b>Color Token:</b> PaperWhite
<b>Description:</b> PaperWhite 0.5mm Solid Line		
<u>Parameters:</u>		
<b>Line Weight:</b> 0.5mm		
<b>Component Ref #:</b> L00192	<b>Component Type:</b> Line - Styled	<b>Color Token:</b> Dk-Brown1815
<b>Description:</b> Dk-Brown1815 0.5mm Dashed Line (0.5mm wt, 3.5mm dash, 1.5mm gap)		
<u>Parameters:</u>		
<b>Line Weight:</b> 0.5mm	<b>Dash Length:</b> 3.5mm	<b>Dash Spacing:</b> 1.5mm

### Symbol Rules

Reference #:	Description:	Criteria:
<b>PS-04721</b>	<b>Road / intact / all weather / loose surface / no median / 2 or 3 lanes / primary (line)</b>	Condition of Facility [FUN] = (Fully Functional [6], Unknown [0])
		AND Road Weather Restriction [WTC] = (All-weather [1], Closed in Winter [5])
		AND Load-bearing Surface Type [RST] = (Loose/Unpaved [2], Temporary [8], Unknown [0])
		AND Divided [SEP] = (False [1000], Unknown [0])
		AND Track or Lane Count [LTN] = (2, 3)
		AND Vertical Relative Location [LOC] = (Above Surface [45], On Surface [44], On Waterbody Bottom [17], Unknown [0])
		AND Thoroughfare Class [HCT] = (National Motorway [3], Primary Route [1], Unknown [0])

### Label Rules

**Label Placement Rules (see Annex J):** LP-3630, LP-9999

Reference #:	Description:	Criteria:
<b>PL-04721_1</b>	<b>Road / intact / all weather / loose surface / no median / 2 lanes / primary (line)</b>	Track or Lane Count [LTN] = 2
		AND Road Weather Restriction [WTC] = All-weather [1]
	<b>Label String:</b> [Name]	
	<b>Characteristics:</b> 27 27 (Black, Light Condensed, Italic, 6 pt, Upper case)	
<b>PL-04721_2</b>	<b>Road / intact / all weather / loose surface / no median / 2 lanes / primary / closed in winter (line)</b>	Track or Lane Count [LTN] = 2
		AND Road Weather Restriction [WTC] = Closed in Winter [5]
	<b>Label String:</b> [Name] "CLOSED IN WINTER"	
	<b>Characteristics:</b> 27, 27 27 (Black, Light Condensed, Italic, 6 pt, Upper case)	
<b>PL-04721_3</b>	<b>Road / intact / all weather / loose surface / no median / 3 lanes / primary (line)</b>	Track or Lane Count [LTN] = 3
		AND Road Weather Restriction [WTC] = All-weather [1]
	<b>Label String:</b> [Name] "3 LANES"	
	<b>Characteristics:</b> 27, 27 27 (Black, Light Condensed, Italic, 6 pt, Upper case)	

**PL-04721\_4 Road / intact / all weather / loose surface / no median / 3 lanes / primary / closed in winter (line)**

Track or Lane Count [LTN] = 3

AND Road Weather Restriction [WTC] = Closed in Winter [5]

Label String: [Name] "3 LANES CLOSED IN WINTER"  
 Characteristics: 27, 27  
 27 (Black, Light Condensed, Italic, 6 pt, Upper case)

**Symbol Samples**



**Road / intact / all weather / loose surface / no median / 2 or 3 lanes / secondary (line)**

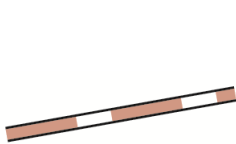

Symbol Graphic

Symbol Placement Instructions: The symbol is applied to the geometry of the feature.

Symbol Type: Compound

Note: The symbol is a combination of three lines. Display Level from bottom to top: Component L00426, Component L00186, Component L00378. No symbol is portrayed if the Vertical Relative Location [LOC] = Below Ground Surface [40].

Component Ref #:	L00426	Component Type:	Line - Simple	Color Token:	Black
Description:	Black 0.7mm Solid Line				
Parameters:					
Line Weight:	0.7mm				
Component Ref #:	L00186	Component Type:	Line - Simple	Color Token:	PaperWhite
Description:	PaperWhite 0.5mm Solid Line				
Parameters:					
Line Weight:	0.5mm				
Component Ref #:	L00378	Component Type:	Line - Styled	Color Token:	Dk-Brown1815-54
Description:	Dk-Brown1815-54 0.5mm Screened Dashed Line (0.5mm wt, 3.5mm, 1.5mm gap)				
Parameters:					
Line Weight:	0.5mm	Dash Length:	3.5mm	Dash Spacing:	1.5mm
Screen Angle:	45 degrees				
Screen Percent:	54%				

**Symbol Rules**

Reference #:	Description:	Criteria:
PS-04723	Road / intact / all weather / loose surface / no median / 2 or 3 lanes / secondary (line)	Condition of Facility [FUN] = (Fully Functional [6], Unknown [0])
	AND	Road Weather Restriction [WTC] = (All-weather [1], Closed in Winter [5])
	AND	Load-bearing Surface Type [RST] = (Loose/Unpaved [2], Temporary [8], Unknown [0])
	AND	Divided [SEP] = (False [1000], Unknown [0])
	AND	Track or Lane Count [LTN] = (2, 3)
	AND	Vertical Relative Location [LOC] = (Above Surface [45], On Surface [44], On Waterbody Bottom [17], Unknown [0])
	AND	Thoroughfare Class [HCT] = (Local Route [4], Secondary Route [2])

**Label Rules**

Label Placement Rules (see Annex J): LP-3630, LP-9999

Reference #:	Description:	Criteria:
PL-04723_1	Road / intact / all weather / loose surface / no median / 2 lanes / secondary (line)	Track or Lane Count [LTN] = 2

AND Road Weather Restriction [WTC] = All-weather [1]

Label String: [Name]

Characteristics: 27  
27 (Black, Light Condensed, Italic, 6 pt, Upper case)

**PL-04723\_2 Road / intact / all weather / loose surface / no median / 2 lanes / secondary / closed in winter (line)** Track or Lane Count [LTN] = 2

AND Road Weather Restriction [WTC] = Closed in Winter [5]

Label String: [Name] "CLOSED IN WINTER"

Characteristics: 27, 27  
27 (Black, Light Condensed, Italic, 6 pt, Upper case)

**PL-04723\_3 Road / intact / all weather / loose surface / no median / 3 lanes / secondary (line)** Track or Lane Count [LTN] = 3

AND Road Weather Restriction [WTC] = All-weather [1]

Label String: [Name] "3 LANES"

Characteristics: 27, 27  
27 (Black, Light Condensed, Italic, 6 pt, Upper case)

**PL-04723\_4 Road / intact / all weather / loose surface / no median / 3 lanes / secondary / closed in winter (line)** Track or Lane Count [LTN] = 3

AND Road Weather Restriction [WTC] = Closed in Winter [5]

Label String: [Name] "3 LANES CLOSED IN WINTER"

Characteristics: 27, 27  
27 (Black, Light Condensed, Italic, 6 pt, Upper case)

Symbol Samples



Road / intact / all weather / loose surface / no median / 1 lane / primary (line)



Symbol Graphic

Symbol Placement Instructions: The symbol is applied to the geometry of the feature.

Symbol Type: Compound

Note: The symbol is a combination of three lines. Display Level from bottom to top: Component L00014, Component L00166, Component L00191. No symbol is portrayed if the Vertical Relative Location [LOC] = Below Ground Surface [40].

Component Ref #:	L00014	Component Type:	Line - Simple	Color Token:	Black
Description:	Black 0.5mm Solid Line				
Parameters:					
Line Weight:	0.5mm				
Component Ref #:	L00166	Component Type:	Line - Simple	Color Token:	PaperWhite
Description:	PaperWhite 0.3mm Solid Line				
Parameters:					
Line Weight:	0.3mm				
Component Ref #:	L00191	Component Type:	Line - Styled	Color Token:	Dk-Brown1815
Description:	Dk-Brown1815 0.3mm Dashed Line (0.3mm wt, 3.5mm dash, 1.5mm gap)				
Parameters:					
Line Weight:	0.3mm	Dash Length:	3.5mm	Dash Spacing:	1.5mm

Symbol Rules

Reference #: Description: Criteria:



**PS-04370** Road / intact / all weather / loose surface / no median / 1 lane / primary (line)

Condition of Facility [FUN] = (Fully Functional [6], Unknown [0])

- AND Road Weather Restriction [WTC] = (All-weather [1], Closed in Winter [5])
- AND Load-bearing Surface Type [RST] = (Loose/Unpaved [2], Temporary [8], Unknown [0])
- AND Divided [SEP] = (False [1000], Unknown [0])
- AND Track or Lane Count [LTN] <= 1
- AND Vertical Relative Location [LOC] = (Above Surface [45], On Surface [44], On Waterbody Bottom [17], Unknown [0])
- AND Thoroughfare Class [HCT] = (National Motorway [3], Primary Route [1], Unknown [0])

**Label Rules**

Label Placement Rules (see Annex J): LP-3630, LP-9999

Reference #:	Description:	Criteria:
<b>PL-04370_1</b>	<b>Road / intact / all weather / loose surface / no median / 1 lane / primary (line)</b> Label String: [Name] Characteristics: 27 27 (Black, Light Condensed, Italic, 6 pt, Upper case)	Road Weather Restriction [WTC] = All-weather [1]
<b>PL-04370_2</b>	<b>Road / intact / all weather / loose surface / no median / 1 lane / primary / closed in winter (line)</b> Label String: [Name] "CLOSED IN WINTER" Characteristics: 27, 27 27 (Black, Light Condensed, Italic, 6 pt, Upper case)	Road Weather Restriction [WTC] = Closed in Winter [5]

**Symbol Samples**



**Road / intact / all weather / loose surface / no median / 1 lane / secondary (line)**

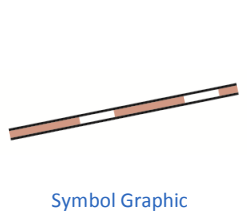

Symbol Graphic

Symbol Placement Instructions: The symbol is applied to the geometry of the feature.

Symbol Type: Compound

Note: The symbol is a combination of three lines. Display Level from bottom to top: Component L00014, Component L00166, Component L00382. No symbol is portrayed if the Vertical Relative Location [LOC] = Below Ground Surface [40].

Component Ref #:	L00014	Component Type:	Line - Simple	Color Token:	Black
Description:	Black 0.5mm Solid Line				
Parameters:					
Line Weight:	0.5mm				
Component Ref #:	L00166	Component Type:	Line - Simple	Color Token:	PaperWhite
Description:	PaperWhite 0.3mm Solid Line				
Parameters:					
Line Weight:	0.3mm				
Component Ref #:	L00382	Component Type:	Line - Styled	Color Token:	Dk-Brown1815-54
Description:	Dk-Brown1815-54 0.3mm Screened Dashed Line (0.3mm wt, 3.5mm, 1.5mm gap)				
Parameters:					
Line Weight:	0.3mm	Dash Length:	3.5mm	Dash Spacing:	1.5mm
Screen Angle:	45 degrees				
Screen Percent:	54%				

**Symbol Rules**

Reference #: Description: Criteria:

**PS-04375** Road / intact / all weather / loose surface / no median / 1 lane / secondary (line)

Condition of Facility [FUN] = (Fully Functional [6], Unknown [0])

- AND Road Weather Restriction [WTC] = (All-weather [1], Closed in Winter [5])
- AND Load-bearing Surface Type [RST] = (Loose/Unpaved [2], Temporary [8], Unknown [0])
- AND Divided [SEP] = (False [1000], Unknown [0])
- AND Track or Lane Count [LTN] <= 1
- AND Vertical Relative Location [LOC] = (Above Surface [45], On Surface [44], On Waterbody Bottom [17], Unknown [0])
- AND Thoroughfare Class [HCT] = (Local Route [4], Secondary Route [2])

**Label Rules**

Label Placement Rules (see Annex J): LP-3630, LP-9999

Reference #:	Description:	Criteria:
<b>PL-04375_1</b>	<b>Road / intact / all weather / loose surface / no median / 1 lane / secondary (line)</b> Label String: [Name] Characteristics: 27 27 (Black, Light Condensed, Italic, 6 pt, Upper case)	Road Weather Restriction [WTC] = All-weather [1]
<b>PL-04375_2</b>	<b>Road / intact / all weather / loose surface / no median / 1 lane / secondary / closed in winter (line)</b> Label String: [Name] "CLOSED IN WINTER" Characteristics: 27, 27 27 (Black, Light Condensed, Italic, 6 pt, Upper case)	Road Weather Restriction [WTC] = Closed in Winter [5]

**Symbol Samples**



**Road / intact / fair weather (line)**



Symbol Graphic

Symbol Placement Instructions: The symbol is applied to the geometry of the feature.

Symbol Type: Compound

Note: The symbol is a combination of two lines. Display Level from bottom to top: Component L00014, Component L00166. No symbol is portrayed if the Vertical Relative Location [LOC] = Below Ground Surface [40].

Component Ref #: L00014      Component Type: Line - Simple      Color Token: Black  
 Description: Black 0.5mm Solid Line  
 Parameters:  
 Line Weight: 0.5mm

Component Ref #: L00166      Component Type: Line - Simple      Color Token: PaperWhite  
 Description: PaperWhite 0.3mm Solid Line  
 Parameters:  
 Line Weight: 0.3mm

**Symbol Rules**

Reference #:	Description:	Criteria:
<b>PS-04366</b>	<b>Road / intact / fair weather (line)</b>	Condition of Facility [FUN] = (Fully Functional [6], Unknown [0])
		AND Road Weather Restriction [WTC] = (Fair-weather [2], Unknown [0], Winter Only [3])
		AND Vertical Relative Location [LOC] = (Above Surface [45], On Surface [44], On Waterbody Bottom [17], Unknown [0])
		AND Thoroughfare Class [HCT] = (Local Route [4], National Motorway [3], Primary Route [1], Secondary Route [2], Unknown [0])

**Label Rules**

Label Placement Rules (see Annex J): LP-3630, LP-9999

<b>Reference #:</b>	<b>Description:</b>	<b>Criteria:</b>
<b>PL-04366_1</b>	<b>Road / intact / fair weather (line)</b>	Road Weather Restriction[WTC] = (Fair-weather [2], Other [999], Unknown [0])
	Label String: [Name]	
	Characteristics: 27	
	27 (Black, Light Condensed, Italic, 6 pt, Upper case)	
<b>PL-04366_2</b>	<b>Road / intact / fair weather / closed in winter (line)</b>	Road Weather Restriction [WTC] = Winter Only [3]
	Label String: [Name] "WINTER ONLY"	
	Characteristics: 27, 27	
	27 (Black, Light Condensed, Italic, 6 pt, Upper case)	

Symbol Samples



Road / intact / street / hard surface (line)



Symbol Graphic

Symbol Placement Instructions: The symbol is applied to the geometry of the feature.

Symbol Type: Compound

Note: The symbol is a combination of two lines. Display Level from bottom to top: Component L00014, Component L00166. No symbol is portrayed if the Vertical Relative Location [LOC] = Below Ground Surface [40]. This symbol is the default symbol for streets in Built Up Areas if not differentiated by Load-bearing Surface Type [RST].

Component Ref #:	L00014	Component Type:	Line - Simple	Color Token:	Black
Description:	Black 0.5mm Solid Line				
Parameters:					
Line Weight:	0.5mm				
Component Ref #:	L00166	Component Type:	Line - Simple	Color Token:	PaperWhite
Description:	PaperWhite 0.3mm Solid Line				
Parameters:					
Line Weight:	0.3mm				

Symbol Rules

<b>Reference #:</b>	<b>Description:</b>	<b>Criteria:</b>
<b>PS-04573</b>	<b>Road / intact / street / hard surface (line)</b>	Condition of Facility [FUN] = (Fully Functional [6], Unknown [0])
	AND	Load-bearing Surface Type [RST] = (Hard/Paved [1], Unknown [0])
	AND	Vertical Relative Location [LOC] = (Above Surface [45], On Surface [44], On Waterbody Bottom [17], Unknown [0])
	AND	Is wholly contained within the limits of a Built-up Area and is not a "through-route"

Symbol Samples



Road / intact / street / loose surface (line)

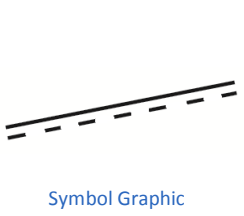

**Symbol Placement Instructions:** The symbol is applied to the geometry of the feature.

**Symbol Type:** Compound

**Note:** The symbol is a combination of three lines. Component L00166 is aligned to the geometry of the feature. The center of Component L00007 is aligned 0.2mm from one side of the geometry of the feature and the center of Component L00089 is aligned 0.2mm from the other side of the geometry of the feature. No symbol is portrayed if the Vertical Relative Location [LOC] = Below Ground Surface [40].

<b>Component Ref #:</b>	L00007	<b>Component Type:</b>	Line - Simple	<b>Color Token:</b>	Black
<b>Description:</b>	Black 0.1mm Solid Line				
<b>Parameters:</b>					
<b>Line Weight:</b>	0.1mm				
<b>Component Ref #:</b>	L00166	<b>Component Type:</b>	Line - Simple	<b>Color Token:</b>	PaperWhite
<b>Description:</b>	PaperWhite 0.3mm Solid Line				
<b>Parameters:</b>					
<b>Line Weight:</b>	0.3mm				
<b>Component Ref #:</b>	L00089	<b>Component Type:</b>	Line - Styled	<b>Color Token:</b>	Black
<b>Description:</b>	Black 0.1mm Dashed line (0.1mm wt, 1.0mm dash, 1.0mm gap)				
<b>Parameters:</b>					
<b>Line Weight:</b>	0.1mm	<b>Dash Length:</b>	1.0mm	<b>Dash Spacing:</b>	1.0mm

### Symbol Rules

<b>Reference #:</b>	<b>Description:</b>	<b>Criteria:</b>
PS-04690	Road / intact / street / loose surface (line)	Condition of Facility [FUN] = (Fully Functional [6], Unknown [0])
		AND Load-bearing Surface Type [RST] = (Loose/Unpaved [2], Temporary [8])
		AND Vertical Relative Location [LOC] = (Above Surface [45], On Surface [44], On Waterbody Bottom [17],Unknown [0])
		AND Is wholly contained within the limits of a Built-up Area and is not a "through-route"

### Symbol Samples



### Road / not intact / median (line)

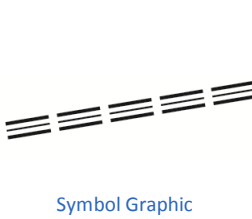

**Symbol Placement Instructions:** The symbol is applied to a line equidistant between the two extracted traveled ways of the divided road.

**Symbol Type:** Compound

**Note:** The symbol is a combination of four lines. Display Level from bottom to top: Component L00439, Component L00440, Component L00183, Component L00170. Gaps in the lines are coincident. No symbol is portrayed if the Vertical Relative Location [LOC] = Below Ground Surface [40].

<b>Component Ref #:</b>	L00439	<b>Component Type:</b>	Line - Simple	<b>Color Token:</b>	PaperWhite
<b>Description:</b>	PaperWhite 1.1mm Solid Line				
<b>Parameters:</b>					
<b>Line Weight:</b>	1.1mm				
<b>Component Ref #:</b>	L00440	<b>Component Type:</b>	Line - Styled	<b>Color Token:</b>	Black
<b>Description:</b>	Black 1.1mm Dashed Line (1.1mm wt, 2.5mm dash, 0.5mm gap)				
<b>Parameters:</b>					
<b>Line Weight:</b>	1.1mm	<b>Dash Length:</b>	2.5mm	<b>Dash Spacing:</b>	0.5mm

Component Ref #:	L00183	Component Type:	Line - Simple	Color Token:	PaperWhite
Description:	PaperWhite 0.8mm Solid Line				
Parameters:					
Line Weight:	0.8mm				

Component Ref #:	L00170	Component Type:	Line - Styled	Color Token:	Black
Description:	Black 0.1mm Dashed Line (0.1mm wt, 2.5mm dash, 0.5mm gap)				
Parameters:					
Line Weight:	0.1mm	Dash Length:	2.5mm	Dash Spacing:	0.5mm

**Symbol Rules**

Reference #:	Description:	Criteria:
PS-04572	Road / not intact / median (line)	Condition of Facility [FUN] = (Abandoned [2], Damaged [13], Destroyed [3], Dismantled [4], Under Construction [1])
	AND	Divided [SEP] = True [1001]
	AND	Vertical Relative Location [LOC] = (Above Surface [45], On Surface [44], On Waterbody Bottom [17], Unknown [0])
	AND	Text [TXT] = Component of Dual Carriageway; traffic flowing in one direction

**Label Rules**

Label Placement Rules (see Annex J): LP-3630, LP-9950, LP-9999

Reference #:	Description:	Criteria:
PL-04572_1	Road / not intact / median (line)	N/A
	Label String:	[Name] "[Condition of Facility]"
	Characteristics:	27, 27, 27, 27 27 (Black, Light Condensed, Italic, 6 pt, Upper case)

**Symbol Samples**



**Road / not intact / no median (line)**

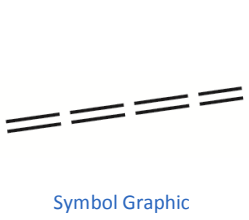

Symbol Placement Instructions: The symbol is applied to the geometry of the feature.

Symbol Type: Compound

Note: The symbol is a combination of three lines. Display Level from bottom to top: Component L00427, Component L00428, Component L00186. No symbol is portrayed if the Vertical Relative Location [LOC] = Below Ground Surface [40].

Component Ref #:	L00427	Component Type:	Line - Simple	Color Token:	PaperWhite
Description:	PaperWhite 0.7mm Solid Line				
Parameters:					
Line Weight:	0.7mm				

Component Ref #:	L00428	Component Type:	Line - Styled	Color Token:	Black
Description:	Black 0.7mm Dashed Line ( 0.7mm wt, 2.5mm dash, 0.5mm gap)				
Parameters:					
Line Weight:	0.7mm	Dash Length:	2.5mm	Dash Spacing:	0.5mm

Component Ref #:	L00186	Component Type:	Line - Simple	Color Token:	PaperWhite
Description:	PaperWhite 0.5mm Solid Line				
Parameters:					
Line Weight:	0.5mm				

**Symbol Rules**

Reference #:	Description:	Criteria:
PS-04574	Road / not intact / no median (line)	Condition of Facility [FUN] = (Abandoned [2], Damaged [13], Destroyed [3], Dismantled [4], Under Construction [1])
	AND	Divided [SEP] = (False [1000], Unknown [0])

AND Vertical Relative Location [LOC] = (Above Surface [45], On Surface [44], On Waterbody Bottom [17], Unknown [0])

Label Rules

Label Placement Rules (see Annex J): LP-3630, LP-9950, LP-9999

Reference #:	Description:	Criteria:
PL-04574_1	Road / not intact / no median (line)	N/A

Label String: [Name] "["[Condition of Facility]"  
 Characteristics: 27, 27, 27, 27  
 27 (Black, Light Condensed, Italic, 6 pt, Upper case)

Symbol Samples



Road Route Marker (No Code)

Road Route Marker / international (point)

Symbol Placement Instructions: The symbol is manually placed on the road feature. Origin: Center of symbol.  
 Symbol Type: Simple



Symbol Graphic

Component Ref #:	P00267	Component Type:	Point - Simple	Color Token:	Black
Description:	Road route marker international				
Parameters:					
Line Weight:	0.2mm				
Length:	4.5mm long; 2.5mm wide				
Note:	The component is an open rectangle.				

Symbol Rules

Reference #:	Description:	Criteria:
PS-04638	Road Route Marker / international (point)	Road (AP030) and designated with an international route number.

Label Rules

Label Placement Rules (see Annex J): LP-3996

Reference #:	Description:	Criteria:
PL-04638_1	Road Route Marker / international (point)	N/A

Label String: [Name]  
 Characteristics: 1  
 1 (Black, Condensed, 6 pt, Mixed case)

Symbol Samples



Shown with Road:



Road Route Marker / national motorway (point)

**Symbol Placement Instructions:** The symbol is manually placed on the road feature. Origin: Center of symbol.

**Symbol Type:** Simple

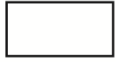

Symbol Graphic

<b>Component Ref #:</b>	P00158	<b>Component Type:</b>	Point - Simple	<b>Color Token:</b>	Black
<b>Description:</b>	Road route marker national motorway non-USA				
<b>Parameters:</b>					
<b>Line Weight:</b>	0.1mm				
<b>Length:</b>	4.5mm long; 2.25mm wide				
<b>Note:</b>	The component is an open rectangle.				

**Symbol Rules**

<b>Reference #:</b>	<b>Description:</b>	<b>Criteria:</b>
PS-04623	Road Route Marker / national motorway (point)	Road (AP030) and designated with a national motorway route number.

**Label Rules**

Label Placement Rules (see Annex J): LP-3996

<b>Reference #:</b>	<b>Description:</b>	<b>Criteria:</b>
PL-04623_1	Road Route Marker / national motorway (point)	N/A

**Label String:** [Name]  
**Characteristics:** 1  
 1 (Black, Condensed, 6 pt, Mixed case)

**Symbol Samples**



Shown with Road:

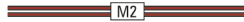

**Road Route Marker / national (point)**

**Symbol Placement Instructions:** The symbol is manually placed on the road feature. Origin: Center of symbol.

**Symbol Type:** Simple



Symbol Graphic

<b>Component Ref #:</b>	P00268	<b>Component Type:</b>	Point - Shape	<b>Color Token:</b>	Black
<b>Description:</b>	Road route marker national non-USA				
<b>Parameters:</b>					
<b>Note:</b>	See Annex H for detailed drawing instructions.				

**Symbol Rules**

<b>Reference #:</b>	<b>Description:</b>	<b>Criteria:</b>
PS-04639	Road Route Marker / national (point)	Road (AP030) and designated with an national route number.

**Label Rules**

Label Placement Rules (see Annex J): LP-3996

<b>Reference #:</b>	<b>Description:</b>	<b>Criteria:</b>
PL-04639_1	Road Route Marker / national (point)	N/A

**Label String:** [Name]  
**Characteristics:** 1  
 1 (Black, Condensed, 6 pt, Mixed case)

Symbol Samples

20

Shown with Road:

20

Road Route Marker / local, secondary (point)



Symbol Graphic

Symbol Placement Instructions: The symbol is manually placed on the road feature. Origin: Center of symbol.  
 Symbol Type: Simple

Component Ref #:	P00160	Component Type:	Point - Simple	Color Token:	Black
Description:	Road route marker local/secondary				
<u>Parameters:</u>					
Diameter:	3.8mm				
Line Weight:	0.1mm				
Note:	The component is an open circle.				

Symbol Rules

Reference #:	Description:	Criteria:
PS-04640	Road Route Marker / local, secondary (point)	Road (AP030) and designated with a local or secondary route number.

Label Rules

Label Placement Rules (see Annex J): LP-3996

Reference #:	Description:	Criteria:
PL-04640_1	Road Route Marker / local, secondary (point)	N/A
	Label String:	[Name]
	Characteristics:	1 1 (Black, Condensed, 6 pt, Mixed case)

Symbol Samples

72

Shown with Road:

72

Roadside Rest Area (AQ135)

Generalization Rules (see Annex J): GA-9999, GC-9999

Roadside Rest Area / all (area)

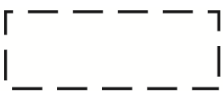

Symbol Graphic

Symbol Placement Instructions: The symbol is applied to the geometry of the feature.  
 Symbol Type: Simple

Component Ref #:	L00210	Component Type:	Line - Styled	Color Token:	Black
Description:	Black 0.1mm Dashed line (0.1mm wt, 1.0mm dash, 0.5mm gap)				
<u>Parameters:</u>					
Line Weight:	0.1mm	Dash Length:	1.0mm	Dash Spacing:	0.5mm



Symbol Rules

Reference #: **PS-04150** Description: **Roadside Rest Area / all (area)** Criteria: All

Label Rules

Label Placement Rules (see Annex J): LP-3506, LP-4813, LP-9950, LP-9999

Reference #: **PL-04150\_1** Description: **Roadside Rest Area / intact (area)** Criteria: Condition of Facility [FUN] = (Fully Functional [6], Unknown [0])

Label String: [Name] "Rest area"  
 Characteristics: 1, 1  
 1 (Black, Condensed, 6 pt, Mixed case)

Reference #: **PL-04150\_2** Description: **Roadside Rest Area / not intact (area)** Criteria: Condition of Facility [FUN] = (Abandoned [2], Damaged [13], Destroyed [3], Dismantled [4], Under Construction [1])

Label String: [Name] "Rest Area" ("[Condition of Facility]")  
 Characteristics: 1, 1, 22, 22, 22  
 1 (Black, Condensed, 6 pt, Mixed case)  
 22 (Black, Condensed, 6 pt, Lower case)

Symbol Samples

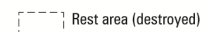

Roadside Rest Area / intact (point)



Symbol Graphic

Symbol Placement Instructions: Origin: Center of symbol  
 Symbol Type: Simple

Component Ref #: P00006 Component Type: Point - Simple Color Token: Black  
 Description: Black filled square with all sides 0.8mm  
Parameters:  
 Length: 0.8mm  
 Note: The component is a square and is filled with the solid color.

Symbol Rules

Reference #: **PS-04604** Description: **Roadside Rest Area / intact (point)** Criteria: Condition of Facility [FUN] = (Fully Functional [6], Unknown [0])

Label Rules

Label Placement Rules (see Annex J): LP-3505

Reference #: **PL-04604\_1** Description: **Roadside Rest Area / intact (point)** Criteria: N/A

Label String: "Rest area"  
 Characteristics: 1  
 1 (Black, Condensed, 6 pt, Mixed case)

Symbol Samples



## Roadside Rest Area / not intact (point)



Symbol Graphic

Symbol Placement Instructions: Origin: Center of symbol  
 Symbol Type: Simple

Component Ref #: P00173      Component Type: Point - Shape      Color Token: Black/Black-12  
 Description: Not intact square 0.8mm  
[Parameters:](#)  
 Note: See Annex H for detailed drawing instructions.

### Symbol Rules

Reference #: **PS-04920**      Description: **Roadside Rest Area / not intact (point)**      Criteria: Condition of Facility [FUN] = (Abandoned [2], Damaged [13], Destroyed [3], Dismantled [4], Under Construction [1])

### Label Rules

Label Placement Rules (see Annex J): LP-3505

Reference #: **PL-04920\_1**      Description: **Roadside Rest Area / not intact (point)**      Criteria: N/A

Label String: "Rest area"  
 Characteristics: 1  
 1 (Black, Condensed, 6 pt, Mixed case)

### Symbol Samples

Rest area  

## Rock Formation (DB160)

Generalization Rules (see Annex J): GA-9999

## Rock Formation / all (area)



Symbol Graphic

Symbol Placement Instructions: The symbol is applied to the geometry of the feature.  
 Symbol Type: Complex  
 Repeating Point and Interval: Component P00069; 0.8mm  
 Note: Component P00069 is perpendicular to and on the downhill side of the edge of Component L00023.

Component Ref #: L00023      Component Type: Line - Simple      Color Token: Dk-Brown1815  
 Description: Dk-Brown1815 0.2mm Solid Line  
[Parameters:](#)  
 Line Weight: 0.2mm

Component Ref #: P00069      Component Type: Point - Simple      Color Token: Dk-Brown1815  
 Description: Dk-Brown1815 1.0mm length line with a 0.2mm lineweight  
[Parameters:](#)  
 Line Weight: 0.2mm  
 Length: 1.0mm

### Symbol Rules

Reference #: **PS-04256**      Description: **Rock Formation / all (area)**      Criteria: All

### Label Rules

Label Placement Rules (see Annex J): LP-0050, LP-3506, LP-9999

Reference #: Description: Criteria:  
**PL-04256\_1** **Rock Formation / all (area)** N/A

Label String: [Name]  
 Characteristics: 8  
 8 (Black, Condensed, Italic, 6-16 pt, Mixed case)

Symbol Samples



Rock Formation / all (line)



Symbol Graphic

**Symbol Placement Instructions:** The symbol is applied to the geometry of the feature.  
**Symbol Type:** Complex  
**Repeating Point and Interval:** Component P00069 has an initial offset of 0.4mm; after that 0.8mm.  
**Note:** Component P00069 is perpendicular to and on the downhill side of the edge of Component L00023.

**Component Ref #:** L00023      **Component Type:** Line - Simple      **Color Token:** Dk-Brown1815  
**Description:** Dk-Brown1815 0.2mm Solid Line  
Parameters:  
**Line Weight:** 0.2mm

**Component Ref #:** P00069      **Component Type:** Point - Simple      **Color Token:** Dk-Brown1815  
**Description:** Dk-Brown1815 1.0mm length line with a 0.2mm lineweight  
Parameters:  
**Line Weight:** 0.2mm  
**Length:** 1.0mm

Symbol Rules

Reference #: Description: Criteria:  
**PS-04088** **Rock Formation / all (line)** All

Label Rules

Label Placement Rules (see Annex J): LP-3630, LP-9999

Reference #: Description: Criteria:  
**PL-04088\_1** **Rock Formation / all (line)** N/A

Label String: [Name]  
 Characteristics: 5  
 5 (Black, Condensed, Italic, 6 pt, Mixed case)

Symbol Samples



Rock Formation / all (point)



Symbol Graphic

Symbol Placement Instructions: Origin: Center of symbol

Symbol Type: Simple

Component Ref #:	P00071	Component Type:	Point - Shape	Color Token:	Dk-Brown1815
Description:	Rock formation				
<a href="#">Parameters:</a>					
Note:	See Annex H for detailed drawing instructions.				

### Symbol Rules

Reference #:	Description:	Criteria:
PS-04257	Rock Formation / all (point)	All

### Label Rules

Label Placement Rules (see Annex J): LP-3505, LP-9999

Reference #:	Description:	Criteria:
PL-04257_1	Rock Formation / all (point)	N/A

Label String: [Name]  
 Characteristics: 5  
 5 (Black, Condensed, Italic, 6 pt, Mixed case)

### Symbol Samples



\* Chimney Rock

## Roundhouse (AN076)

Generalization Rules (see Annex J): GC-9993

### Roundhouse / all (area)



Symbol Graphic

Symbol Placement Instructions: The symbol is applied to the geometry of the feature.

Symbol Type: Simple

Component Ref #:	A00006	Component Type:	Area - Fill	Color Token:	Black
Description:	Black solid fill				
<a href="#">Parameters:</a>					
Note:	The surface geometry is filled with the solid color.				

### Symbol Rules

Reference #:	Description:	Criteria:
PS-04605	Roundhouse / all (area)	All

### Label Rules

Label Placement Rules (see Annex J): LP-3505

Reference #:	Description:	Criteria:
PL-04605_1	Roundhouse / all (area)	N/A

Label String: "Roundhouse"  
 Characteristics: 1  
 1 (Black, Condensed, 6 pt, Mixed case)

Symbol Samples

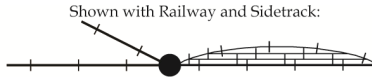

Roundhouse / all (point)

Symbol Graphic



Symbol Placement Instructions: Origin: Center of symbol  
 Symbol Type: Simple

Component Ref #:	P00053	Component Type:	Point - Simple	Color Token:	Black
Description:	Black 0.8mm diameter filled circle				
<u>Parameters:</u>					
Diameter:	0.8mm				
Note:	The component is a circle and is filled with the solid color.				

Symbol Rules

Reference #:	Description:	Criteria:
PS-04606	Roundhouse / all (point)	All

Label Rules

Label Placement Rules (see Annex J): LP-3505

Reference #:	Description:	Criteria:
PL-04606_1	Roundhouse / all (point)	N/A

Label String: "Roundhouse"  
 Characteristics: 1  
 1 (Black, Condensed, 6 pt, Mixed case)

Symbol Samples



Ruins (AL200)

Generalization Rules (see Annex J): GA-9999, GC-9999

Ruins / all (area)



Symbol Graphic

Symbol Placement Instructions: The symbol is applied to the geometry of the feature.  
 Symbol Type: Simple

Component Ref #:	L00210	Component Type:	Line - Styled	Color Token:	Black
Description:	Black 0.1mm Dashed line (0.1mm wt, 1.0mm dash, 0.5mm gap)				
<u>Parameters:</u>					
Line Weight:	0.1mm	Dash Length:	1.0mm	Dash Spacing:	0.5mm

Symbol Rules

Reference #:	Description:	Criteria:
--------------	--------------	-----------

PS-04092 Ruins / all (area) All

Label Rules

Label Placement Rules (see Annex J): LP-3506, LP-4813, LP-9999

Reference #:	Description:	Criteria:
PL-04092_1	Ruins / all (area)	N/A

Label String: [Name] "Ruins"  
 Characteristics: 1, 1  
 1 (Black, Condensed, 6 pt, Mixed case)

Symbol Samples



Ruins / all (point)

Symbol Placement Instructions: Origin: Center of symbol  
 Symbol Type: Simple



Symbol Graphic

Component Ref #:	P00265	Component Type:	Point - Shape	Color Token:	Black
Description:	Ruins				
Parameters:					
Note:	See Annex H for detailed drawing instructions.				

Symbol Rules

Reference #:	Description:	Criteria:
PS-04093	Ruins / all (point)	All

Label Rules

Label Placement Rules (see Annex J): LP-3505, LP-9999

Reference #:	Description:	Criteria:
PL-04093_1	Ruins / all (point)	N/A

Label String: [Name]  
 Characteristics: 1  
 1 (Black, Condensed, 6 pt, Mixed case)

Symbol Samples



Runway (GB055)

Generalization Rules (see Annex J): GA-9999, GC-9994

Runway / intact (area)

**Symbol Placement Instructions:** The symbol is applied to the geometry of the feature.

**Symbol Type:** Simple



Symbol Graphic

**Note:** Label for Runway surface is combined with the label for the associated Land Aerodrome.

<b>Component Ref #:</b>	A00002	<b>Component Type:</b>	Area - Fill	<b>Color Token:</b>	Blue072
<b>Description:</b>	Blue072 solid fill				
<b>Parameters:</b>					
<b>Note:</b>	The surface geometry is filled with the solid color.				

### Symbol Rules

<b>Reference #:</b>	<b>Description:</b>	<b>Criteria:</b>
PS-04428	Runway / intact (area)	Condition of Facility [FUN] = (Fully Functional [6], Unknown [0])

### Label Rules

Label Placement Rules (see Annex J): LP-9990

<b>Reference #:</b>	<b>Description:</b>	<b>Criteria:</b>
PL-04428_1	Runway / intact / hard surface (area)	Load-bearing Surface Type [RST] = Hard/Paved [1]
	<b>Label String:</b> "Hard surface"	
	<b>Characteristics:</b> 24 24 (Blue072, Condensed, 7 pt, Mixed case)	
PL-04428_2	Runway / intact / soft surface (area)	Load-bearing Surface Type [RST] = (Grass/Sod (soft) [5], Loose/Unpaved [2], Unimproved [6])
	<b>Label String:</b> "Soft surface"	
	<b>Characteristics:</b> 24 24 (Blue072, Condensed, 7 pt, Mixed case)	
PL-04428_3	Runway / intact / unknown surface (area)	Load-bearing Surface Type [RST] = (Other [999], Unknown [0])
	<b>Label String:</b> "Surface unknown"	
	<b>Characteristics:</b> 24 24 (Blue072, Condensed, 7 pt, Mixed case)	

### Symbol Samples



## Runway / not intact (area)

**Symbol Placement Instructions:** The symbol is applied to the geometry of the feature.

**Symbol Type:** Complex



Symbol Graphic

**Note:** Component L00217 is applied to the perimeter and is filled with Component A00123. Label for Runway surface is combined with the label for the associated Land Aerodrome.

<b>Component Ref #:</b>	A00123	<b>Component Type:</b>	Area - Fill	<b>Color Token:</b>	Blue072-42
<b>Description:</b>	Blue072-42 area fill				
<b>Parameters:</b>					
<b>Screen Angle:</b>	45 degrees				
<b>Screen Percent:</b>	42%				

<b>Component Ref #:</b>	L00217	<b>Component Type:</b>	Line - Simple	<b>Color Token:</b>	Blue072
<b>Description:</b>	Blue072 0.1mm Solid Line				
<b>Parameters:</b>					

Line Weight: 0.1mm

**Symbol Rules**

<b>Reference #:</b>	<b>Description:</b>	<b>Criteria:</b>
<b>PS-04951</b>	<b>Runway / not intact (area)</b>	Condition of Facility [FUN] = (Abandoned [2], Damaged [13], Destroyed [3], Dismantled [4], Under Construction [1])

**Label Rules**

Label Placement Rules (see Annex J): LP-9990

<b>Reference #:</b>	<b>Description:</b>	<b>Criteria:</b>
<b>PL-04951_1</b>	<b>Runway / not intact / hard surface (area)</b>	Load-bearing Surface Type [RST] = Hard/Paved [1]
	Label String: "Hard surface"	
	Characteristics: 24 24 (Blue072, Condensed, 7 pt, Mixed case)	
<b>PL-04951_2</b>	<b>Runway / not intact / soft surface (area)</b>	Load-bearing Surface Type [RST] = (Grass/Sod (soft) [5], Loose/Unpaved [2], Unimproved [6])
	Label String: "Soft surface"	
	Characteristics: 24 24 (Blue072, Condensed, 7 pt, Mixed case)	
<b>PL-04951_3</b>	<b>Runway / not intact / unknown surface (area)</b>	Load-bearing Surface Type [RST] = (Other [999], Unknown [0])
	Label String: "Surface unknown"	
	Characteristics: 24 24 (Blue072, Condensed, 7 pt, Mixed case)	

**Symbol Samples**

Surface unknown

**Sabkha (BH160)**

Generalization Rules (see Annex J): GA-9999

**Sabkha / all (area)**



Symbol Graphic

**Symbol Placement Instructions:** The symbol is applied to the geometry of the feature.

**Symbol Type:** Complex

**Note:** Component L00041 is applied to the perimeter and is filled with Component A00016.

<b>Component Ref #:</b>	A00016	<b>Component Type:</b>	Area - Pattern	<b>Color Token:</b>	Cyan
<b>Description:</b>	Cyan Sabkha Fill				
<b>Parameters:</b>					
<b>Area Pattern:</b>	AP-103, see Annex I				
<b>Component Ref #:</b>	L00041	<b>Component Type:</b>	Line - Styled	<b>Color Token:</b>	Cyan
<b>Description:</b>	Cyan 0.2mm Dashed Line (0.2mm wt, 2.0mm dash, 0.5mm gap)				
<b>Parameters:</b>					
<b>Line Weight:</b>	0.2mm	<b>Dash Length:</b>	2.0mm	<b>Dash Spacing:</b>	0.5mm

**Symbol Rules**

<b>Reference #:</b>	<b>Description:</b>	<b>Criteria:</b>
<b>PS-04209</b>	<b>Sabkha / all (area)</b>	All

**Label Rules**

Label Placement Rules (see Annex J): LP-0050, LP-3506, LP-9999

<b>Reference #:</b>	<b>Description:</b>	<b>Criteria:</b>
<b>PL-04209_1</b>	<b>Sabkha / all (area)</b>	N/A



Label String: [Name]  
 Characteristics: 37  
 37 (Cyan, Condensed, Italic, 7-16 pt, Upper case)

Symbol Samples



**Salt Evaporator (BH155)**

Generalization Rules (see Annex J): GA-9999, GC-9999

**Salt Evaporator / all (area)**



Symbol Graphic

Symbol Placement Instructions: The symbol is applied to the geometry of the feature.

Symbol Type: Complex

Note: Component L00015 is applied to the perimeter and is filled with Component A00044.

Component Ref #:	A00044	Component Type:	Area - Pattern	Color Token:	Cyan
Description:	Cyan Salt Evaporator Fill				
Parameters:					
Area Pattern:	No existing MIL_STD_2410 area pattern. See Annex I for detailed drawing instructions.				

Component Ref #:	L00015	Component Type:	Line - Simple	Color Token:	Cyan
Description:	Cyan 0.2mm Solid Line				
Parameters:					
Line Weight:	0.2mm				

Symbol Rules

Reference #:	Description:	Criteria:
PS-04208	Salt Evaporator / all (area)	All

Symbol Samples

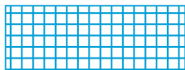

**Salt Evaporator / all (point)**

Symbol Placement Instructions: Origin: Center of symbol

Symbol Type: Simple



Symbol Graphic

Component Ref #:	P00157	Component Type:	Point - Simple	Color Token:	Cyan
Description:	Salt evaporator				
Parameters:					
Line Weight:	0.2mm				
Length:	1.5mm				
Note:	The component is an open square.				

Symbol Rules

Reference #: Description: Criteria:  
**PS-04607** Salt Evaporator / all (point) All

Label Rules

Label Placement Rules (see Annex J): LP-3505

Reference #: Description: Criteria:  
**PL-04607\_1** Salt Evaporator / all (point) N/A

Label String: "Salt evaporator"  
 Characteristics: 16  
 16 (Cyan, Condensed, Italic, 6 pt, Mixed case)

Symbol Samples

 Salt evaporator

Salt Flat (BH150)

Generalization Rules (see Annex J): GA-9999

Salt Flat / all (area)



Symbol Graphic

Symbol Placement Instructions: The symbol is applied to the geometry of the feature.

Symbol Type: Complex

Note: Component L00041 is applied to the perimeter and is filled with Component A00020.

Component Ref #:	A00020	Component Type:	Area - Pattern	Color Token:	Cyan
Description:	Cyan Dry Drainage Fill				
<a href="#">Parameters:</a>					
Area Pattern:	AP-95, see Annex I				

Component Ref #:	L00041	Component Type:	Line - Styled	Color Token:	Cyan
Description:	Cyan 0.2mm Dashed Line (0.2mm wt, 2.0mm dash, 0.5mm gap)				
<a href="#">Parameters:</a>					
Line Weight:	0.2mm	Dash Length:	2.0mm	Dash Spacing:	0.5mm

Symbol Rules

Reference #: Description: Criteria:  
**PS-04608** Salt Flat / all (area) All

Label Rules

Label Placement Rules (see Annex J): LP-0050, LP-3506, LP-4813, LP-9999

Reference #: Description: Criteria:  
**PL-04608\_1** Salt Flat / all (area) N/A

Label String: [Name] "Salt flat"  
 Characteristics: 38, 38  
 38 (Cyan, Condensed, Italic, 6-16 pt, Mixed case)

Symbol Samples



## Sand Dunes (DB170)

Generalization Rules (see Annex J): GA-9999

### Sand Dunes / unknown (area)

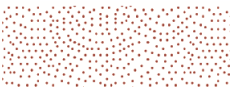

Symbol Graphic

**Symbol Placement Instructions:** The symbol is applied to the geometry of the feature.

**Symbol Type:** Simple

<b>Component Ref #:</b> A00035	<b>Component Type:</b> Area - Pattern	<b>Color Token:</b> Dk-Brown1815
<b>Description:</b> Dk-Brown1815 Sand Fill		
<u>Parameters:</u>		
<b>Area Pattern:</b> AP-95, see Annex I		

#### Symbol Rules

<b>Reference #:</b> PS-04258	<b>Description:</b> Sand Dunes / unknown (area)	<b>Criteria:</b> Sand Dune Type [SDT] = Unknown [0]
------------------------------	---	---

#### Label Rules

Label Placement Rules (see Annex J): LP-0050, LP-3506, LP-4813, LP-9999

<b>Reference #:</b> PL-04258_1	<b>Description:</b> Sand Dunes / unknown (area)	<b>Criteria:</b> N/A
--------------------------------	---	----------------------

**Label String:** [Name] "Dunes"

**Characteristics:** 7, 7  
7 (Black, Condensed, Italic, 7-10 pt, Mixed case)

#### Symbol Samples



### Sand Dunes / crescent (area)

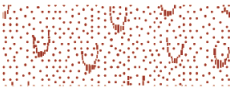

Symbol Graphic

**Symbol Placement Instructions:** The symbol is applied to the geometry of the feature.

**Symbol Type:** Simple

**Note:** The symbol is rotated to the Sand Dune Orientation (SDO) value.

<b>Component Ref #:</b> A00031	<b>Component Type:</b> Area - Pattern	<b>Color Token:</b> Dk-Brown1815
<b>Description:</b> Dk-Brown1815 Crescent Sand Dunes Fill		
<u>Parameters:</u>		
<b>Area Pattern:</b> AP-108, see Annex I		

#### Symbol Rules

<b>Reference #:</b> PS-04259	<b>Description:</b> Sand Dunes / crescent (area)	<b>Criteria:</b> Sand Dune Type [SDT] = (Crescent [1], Parabolic [5])
------------------------------	--	---

#### Label Rules

Label Placement Rules (see Annex J): LP-0050, LP-3506, LP-9999

<b>Reference #:</b> PL-04259_1	<b>Description:</b> Sand Dunes / crescent (area)	<b>Criteria:</b> N/A
--------------------------------	--	----------------------

**Label String:** [Name]

**Characteristics:** 7

7 (Black, Condensed, Italic, 7-10 pt, Mixed case)

Symbol Samples



Sand Dunes / dome (area)

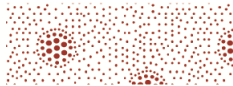

Symbol Graphic

Symbol Placement Instructions: The symbol is applied to the geometry of the feature.

Symbol Type: Simple

Component Ref #:	A00042	Component Type:	Area - Pattern	Color Token:	Dk-Brown1815
Description:	Dk-Brown1815 Dome Sand Dunes Fill				
Parameters:	Area Pattern: AP-126, see Annex I				

Symbol Rules

Reference #:	Description:	Criteria:
PS-04264	Sand Dunes / dome (area)	Sand Dune Type [SDT] = Dome [2]

Label Rules

Label Placement Rules (see Annex J):		LP-0050, LP-3506, LP-9999
Reference #:	Description:	Criteria:
PL-04264_1	Sand Dunes / dome (area)	N/A
Label String:	[Name]	
Characteristics:	7 7 (Black, Condensed, Italic, 7-10 pt, Mixed case)	

Symbol Samples

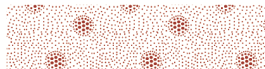

Sand Dunes / transverse (area)



Symbol Graphic

Symbol Placement Instructions: The symbol is applied to the geometry of the feature.

Symbol Type: Simple

Note: The symbol is rotated to the Sand Dune Orientation (SDO) value.

Component Ref #:	A00034	Component Type:	Area - Pattern	Color Token:	Dk-Brown1815
Description:	Dk-Brown1815 Transverse Sand Dunes Fill				
Parameters:	Area Pattern: AP-127, see Annex I				

Symbol Rules

Reference #:	Description:	Criteria:
PS-04260	Sand Dunes / transverse (area)	Sand Dune Type [SDT] = (Dome and Transverse [8], Transverse [3])

Label Rules

Label Placement Rules (see Annex J):	LP-0050, LP-3506, LP-9999
--------------------------------------	---------------------------

Reference #: Description: Criteria:  
**PL-04260\_1 Sand Dunes / transverse (area)** N/A

Label String: [Name]  
 Characteristics: 7  
 7 (Black, Condensed, Italic, 7-10 pt, Mixed case)

**Symbol Samples**

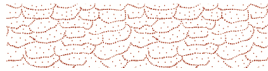

**Sand Dunes / linear (area)**

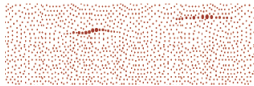

Symbol Graphic

Symbol Placement Instructions: The symbol is applied to the geometry of the feature.

Symbol Type: Simple

Note: The symbol is rotated to the Sand Dune Orientation (SDO) value.

Component Ref #: A00043 Component Type: Area - Pattern Color Token: Dk-Brown1815  
 Description: Dk-Brown1815 Linear Sand Dunes Fill  
 Parameters:  
 Area Pattern: AP-118, see Annex I

**Symbol Rules**

Reference #: Description: Criteria:  
**PS-04261 Sand Dunes / linear (area)** Sand Dune Type [SDT] = Linear [4]

**Label Rules**

Label Placement Rules (see Annex J): LP-0050, LP-3506, LP-9999

Reference #: Description: Criteria:  
**PL-04261\_1 Sand Dunes / linear (area)** N/A

Label String: [Name]  
 Characteristics: 7  
 7 (Black, Condensed, Italic, 7-10 pt, Mixed case)

**Symbol Samples**

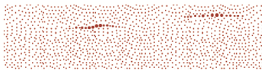

**Sand Dunes / ripple (area)**



Symbol Graphic

Symbol Placement Instructions: The symbol is applied to the geometry of the feature.

Symbol Type: Simple

Note: The symbol is rotated to the Sand Dune Orientation (SDO) value.

Component Ref #: A00032 Component Type: Area - Pattern Color Token: Dk-Brown1815  
 Description: Dk-Brown1815 Ripple Sand Dunes Fill  
 Parameters:

Area Pattern: AP-112, see Annex I

**Symbol Rules**

Reference #: **PS-04262** Description: **Sand Dunes / ripple (area)** Criteria: Sand Dune Type [SDT] = Ripple [6]

**Label Rules**

Label Placement Rules (see Annex J): LP-0050, LP-3506, LP-9999

Reference #: **PL-04262\_1** Description: **Sand Dunes / ripple (area)** Criteria: N/A

Label String: [Name]  
 Characteristics: 7  
 7 (Black, Condensed, Italic, 7-10 pt, Mixed case)

**Symbol Samples**

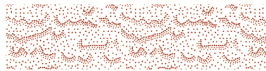

**Sand Dunes / star (area)**

Symbol Placement Instructions: The symbol is applied to the geometry of the feature.  
 Symbol Type: Simple

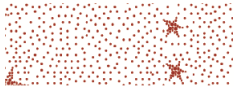

Symbol Graphic

Component Ref #: A00033 Component Type: Area - Pattern Color Token: Dk-Brown1815  
 Description: Dk-Brown1815 Star Sand Dunes Fill  
 Parameters:  
 Area Pattern: AP-120, see Annex I

**Symbol Rules**

Reference #: **PS-04263** Description: **Sand Dunes / star (area)** Criteria: Sand Dune Type [SDT] = Star [7]

**Label Rules**

Label Placement Rules (see Annex J): LP-0050, LP-3506, LP-9999

Reference #: **PL-04263\_1** Description: **Sand Dunes / star (area)** Criteria: N/A

Label String: [Name]  
 Characteristics: 7  
 7 (Black, Condensed, Italic, 7-10 pt, Mixed case)

**Symbol Samples**

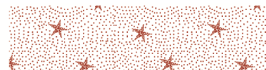

**Seawall (BB230)**

Generalization Rules (see Annex J): GA-9999

**Seawall / all (line)**

**Symbol Placement Instructions:** The symbol is applied to the geometry of the feature.

**Symbol Type:** Simple



Symbol Graphic

<b>Component Ref #:</b>	L00009	<b>Component Type:</b>	Line - Simple	<b>Color Token:</b>	Black
<b>Description:</b>	Black 0.2mm Solid Line				
<u>Parameters:</u>					
<b>Line Weight:</b>	0.2mm				

### Symbol Rules

<b>Reference #:</b>	<b>Description:</b>	<b>Criteria:</b>
PS-04748	Seawall / all (line)	All

### Symbol Samples

Shown with Land Water Boundary and Tidal Water:



## Settlement (AL105)

Generalization Rules (see Annex J): GA-9999

### Settlement / intact (area)



Symbol Graphic

**Symbol Placement Instructions:** The symbol is applied to the geometry of the feature.

**Symbol Type:** Complex

**Note:** Component L00007 is applied to the perimeter and is filled with Component A00122.

<b>Component Ref #:</b>	A00122	<b>Component Type:</b>	Area - Fill	<b>Color Token:</b>	Dk-Brown1815-12
<b>Description:</b>	Dk-Brown1815-12 area fill				
<u>Parameters:</u>					
<b>Screen Angle:</b>	45 degrees				
<b>Screen Percent:</b>	12%				

<b>Component Ref #:</b>	L00007	<b>Component Type:</b>	Line - Simple	<b>Color Token:</b>	Black
<b>Description:</b>	Black 0.1mm Solid Line				
<u>Parameters:</u>					
<b>Line Weight:</b>	0.1mm				

### Symbol Rules

<b>Reference #:</b>	<b>Description:</b>	<b>Criteria:</b>
PS-04085	Settlement / intact (area)	Condition of Facility [FUN] = (Fully Functional [6], Unknown [0])

### Label Rules

Label Placement Rules (see Annex J): LP-3506, LP-9999

<b>Reference #:</b>	<b>Description:</b>	<b>Criteria:</b>
PL-04085_1	Settlement / intact (area)	N/A

**Label String:** [Name]  
**Characteristics:** 41  
 41 (Black, Condensed, 6-12 pt, Mixed case)

### Symbol Samples



### Settlement / not intact (area)

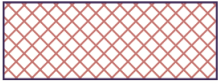

Symbol Graphic

Symbol Placement Instructions: The symbol is applied to the geometry of the feature.

Symbol Type: Simple

Note: Component L00007 is applied to the perimeter and is filled with Component A00063.

Component Ref #:	A00063	Component Type:	Area - Pattern	Color Token:	Dk-Brown1815-54
Description:	Dk-Brown1815-54 Not Intact BUA Screened Fill				
Parameters:					
Area Pattern:	LP-6, see Annex I				
Screen Angle:	45 degrees				
Screen Percent:	54%				

Component Ref #:	L00007	Component Type:	Line - Simple	Color Token:	Black
Description:	Black 0.1mm Solid Line				
Parameters:					
Line Weight:	0.1mm				

#### Symbol Rules

Reference #:	Description:	Criteria:
PS-04053	Settlement / not intact (area)	Condition of Facility [FUN] = (Abandoned [2], Damaged [13], Destroyed [3], Dismantled [4], Under Construction [1])

#### Label Rules

Label Placement Rules (see Annex J): LP-3506, LP-9950, LP-9999

Reference #:	Description:	Criteria:
PL-04053_1	Settlement / not intact (area)	N/A

Label String: [Name] "["[Condition of Facility]"  
 Characteristics: 41, 22, 22, 22  
 41 (Black, Condensed, 6-12 pt, Mixed case)  
 22 (Black, Condensed, 6 pt, Lower case)

#### Symbol Samples



### Settlement / all (point)



Symbol Graphic

Symbol Placement Instructions: Text label only. No graphic parameters

Symbol Type: Simple

#### Symbol Rules

Reference #:	Description:	Criteria:
PS-04086	Settlement / all (point)	All



Label Rules

Label Placement Rules (see Annex J): LP-3505, LP-9950, LP-9999

Reference #: Description:

Criteria:

**PL-04086\_1 Settlement / intact (point)**

Condition of Facility [FUN] = (Fully Functional [6], Unknown [0])

Label String: [Name]

Characteristics: 1  
1 (Black, Condensed, 6 pt, Mixed case)

**PL-04086\_2 Settlement / not intact (point)**

Condition of Facility [FUN] = (Abandoned [2], Damaged [13], Destroyed [3], Dismantled [4], Under Construction [1])

Label String: [Name] "["[Condition of Facility]"

Characteristics: 1, 22, 22, 22  
1 (Black, Condensed, 6 pt, Mixed case)  
22 (Black, Condensed, 6 pt, Lower case)

Symbol Samples

Taos Pueblo

Jamestown (abandoned)

Settling Pond (AC030)

Generalization Rules (see Annex J): GA-9999

Settling Pond / all (area)



Symbol Graphic

Symbol Placement Instructions: The symbol is applied to the geometry of the feature.

Symbol Type: Complex

Note: Component L00007 is applied to the perimeter and is filled with Component A00007.

Component Ref #:	A00007	Component Type:	Area - Fill	Color Token:	Cyan-31
Description:	Cyan-31 area fill				
Parameters:					
Screen Angle:	45 degrees				
Screen Percent:	31%				

Component Ref #:	L00007	Component Type:	Line - Simple	Color Token:	Black
Description:	Black 0.1mm Solid Line				
Parameters:					
Line Weight:	0.1mm				

Symbol Rules

Reference #: Description:

Criteria:

**PS-04292 Settling Pond / all (area)**

All

Symbol Samples



Settling Pond / all (point)



Symbol Graphic

Symbol Placement Instructions: The symbol is applied to the geometry of the feature.

Symbol Type: Simple

Component Ref #: P00288      Component Type: Point - Shape      Color Token: Black/Cyan-31  
 Description: Settling pond  
Parameters:  
 Note: See Annex H for detailed drawing instructions.

Symbol Rules

Reference #: Description: Criteria:  
**PS-04220**    **Settling Pond / all (point)**      All

Symbol Samples



**Shanty Town (AL208)**

Generalization Rules (see Annex J): GA-9999

**Shanty Town / all (area)**

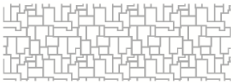

Symbol Graphic

Symbol Placement Instructions: The symbol is applied to the geometry of the feature.

Symbol Type: Simple

Component Ref #: A00014      Component Type: Area - Pattern      Color Token: Black-42  
 Description: Black-42 Shantytown Screened Fill  
Parameters:  
 Area Pattern: AP-132, see Annex I  
 Screen Angle: 45 degrees  
 Screen Percent: 42%

Symbol Rules

Reference #: Description: Criteria:  
**PS-04071**    **Shanty Town / all (area)**      All

Label Rules

Label Placement Rules (see Annex J): LP-0050, LP-3506, LP-9950, LP-9999

Reference #: Description: Criteria:  
**PL-04071\_1**    **Shanty Town / intact (area)**      Condition of Facility [FUN] = (Fully Functional [6], Unknown [0])

Label String: [Name]  
 Characteristics: 41  
 41 (Black, Condensed, 6-12 pt, Mixed case)

**PL-04071\_2 Shanty Town / not intact (area)**

Condition of Facility [FUN] = (Abandoned [2], Damaged [13], Destroyed [3], Dismantled [4], Under Construction [1])

**Label String:** [Name] "["[Condition of Facility]"  
**Characteristics:** 41, 22, 22, 22  
 41 (Black, Condensed, 6-12 pt, Mixed case)  
 22 (Black, Condensed, 6 pt, Lower case)

**Symbol Samples**



**Shed (AL019)**

Generalization Rules (see Annex J): GA-9999, GC-9994

**Shed / all (area)**



Symbol Graphic

**Symbol Placement Instructions:** The symbol is applied to the geometry of the feature.

**Symbol Type:** Simple

**Component Ref #:** A00006      **Component Type:** Area - Fill      **Color Token:** Black  
**Description:** Black solid fill  
Parameters:  
**Note:** The surface geometry is filled with the solid color.

**Symbol Rules**

Reference #:	Description:	Criteria:
PS-04615	Shed / all (area)	All

**Symbol Samples**



**Shed / all (point)**



Symbol Graphic

**Symbol Placement Instructions:** Origin: Center of symbol

**Symbol Type:** Simple

**Component Ref #:** P00050      **Component Type:** Point - Simple      **Color Token:** Black  
**Description:** Black filled square with all sides 0.5mm  
Parameters:  
**Length:** 0.5mm  
**Note:** The component is a square and is filled with the solid color.

**Symbol Rules**

Reference #:	Description:	Criteria:
PS-04616	Shed / all (point)	All

Symbol Samples

## Ski Jump (AK150)

Generalization Rules (see Annex J): GA-9999

### Ski Jump / non-obstruction (line)



Symbol Graphic

Symbol Placement Instructions: The symbol is applied to the geometry of the feature.

Symbol Type: Simple

Component Ref #:	L00032	Component Type:	Line - Styled	Color Token:	Black
Description:	Black 0.2mm Dashed Line (0.2mm wt, 2.0mm dash, 0.5mm gap)				
<u>Parameters:</u>					
Line Weight:	0.2mm	Dash Length:	2.0mm	Dash Spacing:	0.5mm

#### Symbol Rules

Reference #:	Description:	Criteria:
PS-04625	Ski Jump / non-obstruction (line)	Height Above Surface Level [HGT] < 46

#### Label Rules

Label Placement Rules (see Annex J): LP-3630

Reference #:	Description:	Criteria:
PL-04625_1	Ski Jump / non-obstruction (line)	N/A

Label String: "Ski jump"  
 Characteristics: 1  
 1 (Black, Condensed, 6 pt, Mixed case)

Symbol Samples



### Ski Jump / obstruction (line)



Symbol Graphic

Symbol Placement Instructions: The symbol is applied to the geometry of the feature.

Symbol Type: Simple

Component Ref #:	L00006	Component Type:	Line - Simple	Color Token:	Blue072
Description:	Blue072 0.73mm Solid Line				
<u>Parameters:</u>					
Line Weight:	0.73mm				

Symbol Rules

Reference #:	Description:	Criteria:
PS-04928	Ski Jump / obstruction (line)	Height Above Surface Level [HGT] >= 46

Label Rules

Label Placement Rules (see Annex J): LP-9991

Reference #:	Description:	Criteria:
PL-04928_1	Ski Jump / obstruction (line)	N/A

Label String: "Ski jump"  
 [Highest Elevation]  
 ("[Height Above Surface Level]")"

Characteristics: 15  
 46  
 95, 95, 95  
 15 (Blue072, Condensed, 6 pt, Mixed case)  
 46 (Blue072, Condensed, Bold, 6 pt, Lower case)

Symbol Samples



Ski Jump / non-obstruction (point)



Symbol Graphic

Symbol Placement Instructions: Origin: Center of symbol  
 Symbol Type: Simple

Component Ref #:	P00274	Component Type:	Point - Shape	Color Token:	Black
Description:	Ski jump				
Parameters:					
Note:	See Annex H for detailed drawing instructions.				

Symbol Rules

Reference #:	Description:	Criteria:
PS-04626	Ski Jump / non-obstruction (point)	Height Above Surface Level [HGT] < 46

Symbol Samples



Ski Jump / obstruction (point)



Symbol Graphic

Symbol Placement Instructions: Origin: Center of open circle  
 Symbol Type: Simple

Component Ref #: P00113      Component Type: Point - Shape      Color Token: Blue072  
 Description: Vertical obstruction linear  
Parameters:  
 Note: See Annex H for detailed drawing instructions.

**Symbol Rules**

Reference #: **PS-04929**      Description: **Ski Jump / obstruction (point)**      Criteria: Height Above Surface Level [HGT] >= 46

**Label Rules**

Label Placement Rules (see Annex J): LP-9992

Reference #: **PL-04929\_1**      Description: **Ski Jump / obstruction (point)**      Criteria: N/A

Label String: "Ski jump"  
 [Highest Elevation]  
 ("[Height Above Surface Level]")  
 Characteristics: 15  
 46  
 95, 95, 95  
 15 (Blue072, Condensed, 6 pt, Mixed case)  
 46 (Blue072, Condensed, Bold, 6 pt, Lower case)

**Symbol Samples**



**Slipway (BB240)**

Generalization Rules (see Annex J): GA-9999

**Slipway / dry (area)**



Symbol Graphic

Symbol Placement Instructions: The symbol is applied to the geometry of the feature.

Symbol Type: Simple

Note: This symbol is portrayed in conjunction with the Tidal Water symbol and shall mask out the Tidal Water symbol.

Component Ref #: L00007      Component Type: Line - Simple      Color Token: Black  
 Description: Black 0.1mm Solid Line  
Parameters:  
 Line Weight: 0.1mm

**Symbol Rules**

Reference #: **PS-04750**      Description: **Slipway / dry (area)**      Criteria: Water Level Effect [WLE] = (Always Dry [2], Floating [8], Not Applicable [998], Other [999], Unknown [0])

**Label Rules**

Label Placement Rules (see Annex J): LP-3505

Reference #: **PL-04750\_1**      Description: **Slipway / dry (area)**      Criteria: N/A

Label String: "Slipway"  
 Characteristics: 1  
 1 (Black, Condensed, 6 pt, Mixed case)

**Symbol Samples**

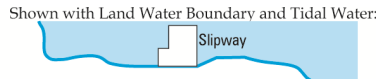

## Slipway / not dry (area)

**Symbol Placement Instructions:** The symbol is applied to the geometry of the feature.

**Symbol Type:** Complex



Symbol Graphic

**Note:** The symbol is shown in conjunction with Tidal Water symbol and shall not mask out the Tidal Water symbol.

<b>Component Ref #:</b>	A00048	<b>Component Type:</b>	Area - Fill	<b>Color Token:</b>	Black-12
<b>Description:</b>	Black-12 area fill				
<b>Parameters:</b>					
<b>Screen Angle:</b>	15 degrees				
<b>Screen Percent:</b>	12%				

<b>Component Ref #:</b>	L00210	<b>Component Type:</b>	Line - Styled	<b>Color Token:</b>	Black
<b>Description:</b>	Black 0.1mm Dashed line (0.1mm wt, 1.0mm dash, 0.5mm gap)				
<b>Parameters:</b>					
<b>Line Weight:</b>	0.1mm	<b>Dash Length:</b>	1.0mm	<b>Dash Spacing:</b>	0.5mm

### Symbol Rules

<b>Reference #:</b>	<b>Description:</b>	<b>Criteria:</b>
PS-04751	Slipway / not dry (area)	Water Level Effect [WLE] = (Always Submerged [3], Covers and Uncovers [4], Partly Submerged [1])

### Label Rules

Label Placement Rules (see Annex J): LP-3505

<b>Reference #:</b>	<b>Description:</b>	<b>Criteria:</b>
PL-04751_1	Slipway / not dry (area)	N/A

**Label String:** "Slipway"  
**Characteristics:** 1  
 1 (Black, Condensed, 6 pt, Mixed case)

### Symbol Samples



## Sluice Gate (BI040)

Generalization Rules (see Annex J): GA-9999

### Sluice Gate / all (line)

**Symbol Placement Instructions:** The symbol is applied to the geometry of the feature.

**Symbol Type:** Simple



Symbol Graphic

<b>Component Ref #:</b>	L00009	<b>Component Type:</b>	Line - Simple	<b>Color Token:</b>	Black
<b>Description:</b>	Black 0.2mm Solid Line				
<b>Parameters:</b>					
<b>Line Weight:</b>	0.2mm				

Symbol Rules

Reference #: PS-04224 Description: Sluice Gate / all (line) Criteria: All

Label Rules

Label Placement Rules (see Annex J): LP-3505

Reference #: PL-04224\_1 Description: Sluice Gate / all (line) Criteria: N/A

Label String: "Sluice gate"  
 Characteristics: 1  
 1 (Black, Condensed, 6 pt, Mixed case)

Symbol Samples



Sluice Gate / all (point)



Symbol Graphic

Symbol Placement Instructions: Origin: Apex of "V"

Symbol Type: Simple

Note: Component P00105 is centered on the associated drainage symbol with apex pointing upstream.

Component Ref #: P00105 Component Type: Point - Shape Color Token: Black  
 Description: Lock/pedestrian bridge/sluice gate "V"  
 Parameters:  
 Note: See Annex H for detailed drawing instructions.

Symbol Rules

Reference #: PS-04225 Description: Sluice Gate / all (point) Criteria: All

Symbol Samples



Smokestack (AF010)

Smokestack / non-obstruction (point)



Symbol Graphic

Symbol Placement Instructions: Origin: Center of open circle

Symbol Type: Simple

Component Ref #: P00140 Component Type: Point - Shape Color Token: Black  
 Description: Smokestack  
 Parameters:



Note: See Annex H for detailed drawing instructions.

Symbol Rules

Reference #:	Description:	Criteria:
<b>PS-04301</b>	<b>Smokestack / non-obstruction (point)</b>	Height Above Surface Level [HGT] < 46

Symbol Samples



**Snow Ice Field (BJ100)**

Generalization Rules (see Annex J): GA-9999

**Snow Ice Field / all (area)**



Symbol Graphic

Symbol Placement Instructions: The symbol is applied to the geometry of the feature.

Symbol Type: Complex

Note: Component L00041 is applied to the perimeter and is filled with Component A00008.

Component Ref #:	A00008	Component Type:	Area - Fill	Color Token:	Cyan-04
Description:	Cyan-04 area fill				
Parameters:					
Screen Angle:	45 degrees				
Screen Percent:	4%				

---

Component Ref #:	L00041	Component Type:	Line - Styled	Color Token:	Cyan
Description:	Cyan 0.2mm Dashed Line (0.2mm wt, 2.0mm dash, 0.5mm gap)				
Parameters:					
Line Weight:	0.2mm	Dash Length:	2.0mm	Dash Spacing:	0.5mm

Symbol Rules

Reference #:	Description:	Criteria:
<b>PS-04232</b>	<b>Snow Ice Field / all (area)</b>	All

Label Rules

Label Placement Rules (see Annex J): LP-0050, LP-3506, LP-9999

Reference #:	Description:	Criteria:
<b>PL-04232_1</b>	<b>Snow Ice Field / all (area)</b>	N/A

Label String: [Name]  
 Characteristics: 38  
 38 (Cyan, Condensed, Italic, 6-16 pt, Mixed case)

Symbol Samples



**Soil Surface Region (DA010)**

Generalization Rules (see Annex J): GA-9999

**Soil Surface Region / distorted surface (area)**

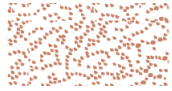

Symbol Graphic

Symbol Placement Instructions: The symbol is applied to the geometry of the feature.

Symbol Type: Simple

Component Ref #:	A00030	Component Type:	Area - Pattern	Color Token:	Dk-Brown1815-54
Description:	Dk-Brown1815-54 Distorted Surface Screened Fill				
<u>Parameters:</u>					
Area Pattern:	AP-103, see Annex I				
Screen Angle:	45 degrees				
Screen Percent:	54%				

### Symbol Rules

Reference #:	Description:	Criteria:
PS-04235	Soil Surface Region / distorted surface (area)	Surface Material Type [SMC] = (Boulders [8], Lava [52], Rock [84])

### Label Rules

Label Placement Rules (see Annex J): LP-3506

Reference #:	Description:	Criteria:
PL-04235_1	Soil Surface Region / distorted surface / boulders (area)	Surface Material Type [SMC] = Boulders [3]
	Label String: "Boulders"	
	Characteristics: 5 5 (Black, Condensed, Italic, 6 pt, Mixed case)	
PL-04235_2	Soil Surface Region / distorted surface / rocky (area)	Surface Material Type [SMC] = Rock [84]
	Label String: "Rocky"	
	Characteristics: 5 5 (Black, Condensed, Italic, 6 pt, Mixed case)	
PL-04235_3	Soil Surface Region / distorted surface / lava (area)	Surface Material Type [SMC] = Lava [52]
	Label String: "Lava"	
	Characteristics: 5 5 (Black, Condensed, Italic, 6 pt, Mixed case)	

### Symbol Samples



Rocky



Boulders

## Soil Surface Region / gravel (area)



Symbol Graphic

Symbol Placement Instructions: The symbol is applied to the geometry of the feature.

Symbol Type: Simple

Component Ref #:	A00036	Component Type:	Area - Pattern	Color Token:	Dk-Brown1815
Description:	Dk-Brown1815 Gravel Fill				
<u>Parameters:</u>					
Area Pattern:	AP-99, see Annex I				

Symbol Rules

Reference #: **PS-04237** Description: **Soil Surface Region / gravel (area)** Criteria: Surface Material Type [SMC] = (Gravel [46], Sand and Gravel [120])

Label Rules

Label Placement Rules (see Annex J): LP-3506

Reference #: **PL-04237\_1** Description: **Soil Surface Region / gravel (area)** Criteria: Surface Material Type [SMC] = Sand and Gravel [120]

Label String: "Sand and gravel"  
 Characteristics: 5  
 5 (Black, Condensed, Italic, 6 pt, Mixed case)

Symbol Samples

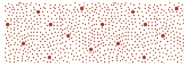

Soil Surface Region / sand (area)



Symbol Graphic

Symbol Placement Instructions: The symbol is applied to the geometry of the feature.  
 Symbol Type: Simple

Component Ref #: A00035 Component Type: Area - Pattern Color Token: Dk-Brown1815  
 Description: Dk-Brown1815 Sand Fill  
 Parameters: Area Pattern: AP-95, see Annex I

Symbol Rules

Reference #: **PS-04238** Description: **Soil Surface Region / sand (area)** Criteria: Surface Material Type [SMC] = (Sand [88], Sand and Boulders [124], Sand and Mud [126])

Label Rules

Label Placement Rules (see Annex J): LP-3506

Reference #: **PL-04238\_1** Description: **Soil Surface Region / sand / boulders (area)** Criteria: Surface Material Type [SMC] = Sand and Boulders [124]

Label String: "Sand and boulders"  
 Characteristics: 5  
 5 (Black, Condensed, Italic, 6 pt, Mixed case)

Reference #: **PL-04238\_2** Description: **Soil Surface Region / sand / mud (area)** Criteria: Surface Material Type [SMC] = Sand and Mud [126]

Label String: "Sand and mud"  
 Characteristics: 5  
 5 (Black, Condensed, Italic, 6 pt, Mixed case)

Symbol Samples



Soil Surface Region / other (area)

[SMC]

Symbol Graphic

Symbol Placement Instructions: Text label only. No graphic parameters

Symbol Type: Simple

Symbol Rules

<b>Reference #:</b>	<b>Description:</b>	<b>Criteria:</b>
PS-04880	Soil Surface Region / other (area)	Surface Material Type [SMC] = (Asphalt [5], Concrete [21], Evaporite [122], Frozen Water [103], Ice [257], Limestone [269], Loess [55], Mud [65], Oil [67], Other [999], Salt [87], Snow [258], Soil [104], Unknown [0])

Label Rules

Label Placement Rules (see Annex J): LP-3506

<b>Reference #:</b>	<b>Description:</b>	<b>Criteria:</b>
PL-04880_1	Soil Surface Region / other (area)	Surface Material Type [SMC] = (Asphalt [5], Concrete [21], Evaporite [122], Frozen Water [103], Ice [257], Limestone [269], Loess [55], Mud [65], Oil [67], Salt [87], Snow [258])
	<b>Label String:</b>	[Surface Material Type]
	<b>Characteristics:</b>	5 5 (Black, Condensed, Italic, 6 pt, Mixed case)

Symbol Samples

Limestone

Solar Panel (AD020)

Solar Panel / all (point)



Symbol Graphic

Symbol Placement Instructions: Origin: Center of symbol

Symbol Type: Simple

<b>Component Ref #:</b>	P00010	<b>Component Type:</b>	Point - Shape	<b>Color Token:</b>	Black
<b>Description:</b>	Located object				
<b>Parameters:</b>					
<b>Note:</b>	See Annex H for detailed drawing instructions.				

Symbol Rules

<b>Reference #:</b>	<b>Description:</b>	<b>Criteria:</b>
PS-04719	Solar Panel / all (point)	All

Label Rules

Label Placement Rules (see Annex J): LP-3505

<b>Reference #:</b>	<b>Description:</b>	<b>Criteria:</b>
PL-04719_1	Solar Panel / all (point)	N/A
	<b>Label String:</b>	"Solar panel"
	<b>Characteristics:</b>	1 1 (Black, Condensed, 6 pt, Mixed case)

Symbol Samples

 Solar panel

## Spillway (BH165)

Generalization Rules (see Annex J): GA-9999, GC-9990

### Spillway / all (area)



Symbol Graphic

Symbol Placement Instructions: The symbol is applied to the geometry of the feature.

Symbol Type: Simple

Component Ref #:	L00007	Component Type:	Line - Simple	Color Token:	Black
Description:	Black 0.1mm Solid Line				
<u>Parameters:</u>					
Line Weight:	0.1mm				

#### Symbol Rules

Reference #:	Description:	Criteria:
PS-04629	Spillway / all (area)	All

#### Label Rules

Label Placement Rules (see Annex J): LP-3505

Reference #:	Description:	Criteria:
PL-04629_1	Spillway / all (area)	N/A

Label String: "Spillway"  
 Characteristics: 1  
 1 (Black, Condensed, 6 pt, Mixed case)

#### Symbol Samples



### Spillway / all (line)



Symbol Graphic

Symbol Placement Instructions: The symbol is applied to the geometry of the feature.

Symbol Type: Simple

Component Ref #:	L00010	Component Type:	Line - Simple	Color Token:	Black
Description:	Black 0.25mm Solid Line				
<u>Parameters:</u>					
Line Weight:	0.25mm				

#### Symbol Rules

Reference #:	Description:	Criteria:
PS-04630	Spillway / all (line)	All

#### Label Rules

Label Placement Rules (see Annex J): LP-3505

Reference #: Description: Criteria:  
**PL-04630\_1 Spillway / all (line)** N/A

Label String: "Spillway"  
 Characteristics: 1  
 1 (Black, Condensed, 6 pt, Mixed case)

Symbol Samples

Spillway

**Sports Ground (AK040)**

Generalization Rules (see Annex J): GA-9999

**Sports Ground / all (area)**



Symbol Graphic

Symbol Placement Instructions: The symbol is applied to the geometry of the feature.

Symbol Type: Complex

Note: Component L00361 is applied to the perimeter and is filled with Component A00101. The "S" is centered within the surface geometry of the feature.

Component Ref #: A00101 Component Type: Area - Fill Color Token: Green362-12  
 Description: Green362-12 area fill  
 Parameters:  
 Screen Angle: 45 degrees  
 Screen Percent: 12%

Component Ref #: L00361 Component Type: Line - Simple Color Token: Green362  
 Description: Green362 0.15mm Solid Line  
 Parameters:  
 Line Weight: 0.15mm

Symbol Rules

Reference #: Description: Criteria:  
**PS-04631 Sports Ground / all (area)** All

Label Rules

Label Placement Rules (see Annex J): LP-3506

Reference #: Description: Criteria:  
**PL-04631\_1 Sports Ground / all (area)** N/A

Label String: "S"  
 Characteristics: 115  
 115 (Green, Condensed, 6 pt, Mixed case)

Symbol Samples



**Sports Ground / all (point)**



Symbol Graphic

Symbol Placement Instructions: Origin: Center of symbol

Symbol Type: Simple

Component Ref #:	P00210	Component Type:	Point - Shape	Color Token:	Green362/Green362-1
Description:	Sports ground				
<a href="#">Parameters:</a>					
Note:	See Annex H for detailed drawing instructions.				

Symbol Rules

Reference #:	Description:	Criteria:
PS-04632	Sports Ground / all (point)	All

Symbol Samples



## Spot Elevation (CA030)

### Spot Elevation / not water (point)



Symbol Graphic

Symbol Placement Instructions: Origin: Center of symbol

Symbol Type: Simple

Component Ref #:	P00081	Component Type:	Point - Simple	Color Token:	Black
Description:	Black 0.64mm diameter filled circle				
<a href="#">Parameters:</a>					
Diameter:	0.64mm				
Note:	The component is a circle and is filled with the solid color				

Symbol Rules

Reference #:	Description:	Criteria:
PS-04322	Spot Elevation / not water (point)	Elevation Surface Category [ESC] = (Land [1], Snow Field and/or Ice-field [2], Vegetation [4], Unknown [0])

Label Rules

Label Placement Rules (see Annex J): LP-0073

Reference #:	Description:	Criteria:
PL-04322_1	Spot Elevation / not water / land / highest on sheet (point)	Elevation Surface Category [ESC] = (Land [1], Unknown [0], Vegetation [4])

Label String: [Highest Elevation]  
 Characteristics: 18  
 18 (Black, Condensed, Bold, 10 pt, Lower case)

Reference #:	Description:	Criteria:
PL-04322_2	Spot Elevation / not water / land / normal (point)	Elevation Surface Category [ESC] = (Land [1], Unknown [0], Vegetation [4])

Label String: [Highest Elevation]  
 Characteristics: 25  
 25 (Black, Condensed, 8 pt, Lower case)

**PL-04322\_3 Spot Elevation / not water / snow, ice / highest on sheet (point)**

Elevation Surface Category [ESC] = Snow Field and/or Ice-field [2]

Label String: [Highest Elevation]  
 Characteristics: 17  
 17 (Cyan, Condensed, Bold, 10 pt, Lower case)

**PL-04322\_4 Spot Elevation / not water / snow, ice / normal (point)**

Elevation Surface Category [ESC] = Snow Field and/or Ice-field [2]

Label String: [Highest Elevation]  
 Characteristics: 30  
 30 (Cyan, Condensed, 8 pt, Lower case)

Symbol Samples

305

1238

Highest on sheet:  
 3072

**Spot Elevation / water (point)**

[ZVH]

Symbol Graphic

Symbol Placement Instructions: Text label only. No graphic parameters  
 Symbol Type: Simple

Symbol Rules

Reference #:	Description:	Criteria:
<b>PS-04613</b>	<b>Spot Elevation / water (point)</b>	Elevation Surface Category [ESC] = Inland Water [5]

Label Rules

Label Placement Rules (see Annex J): LP-3506

Reference #:	Description:	Criteria:
<b>PL-04613_1</b>	<b>Spot Elevation / water (point)</b>	N/A

Label String: [Highest Elevation]  
 Characteristics: 30  
 30 (Cyan, Condensed, 8 pt, Lower case)

Symbol Samples

210

Shown with Inland Waterbody:  

**Stadium (AK160)**

Generalization Rules (see Annex J): GA-9999, GC-9999

**Stadium / all (area)**



Symbol Graphic

Symbol Placement Instructions: The symbol is applied to the geometry of the feature.  
 Symbol Type: Simple



Component Ref #: L00014      Component Type: Line - Simple      Color Token: Black  
 Description: Black 0.5mm Solid Line  
[Parameters:](#)  
 Line Weight: 0.5mm

**Symbol Rules**

Reference #: Description: Criteria:  
**PS-04061 Stadium / all (area)** All

**Label Rules**

Label Placement Rules (see Annex J): LP-3505, LP-4813, LP-9950, LP-9999

Reference #: Description: Criteria:  
**PL-04061\_1 Stadium / intact (area)** Condition of Facility [FUN] = (Fully Functional [6], Unknown [0])

Label String: [Name] "Stadium"  
 Characteristics: 1, 1  
 1 (Black, Condensed, 6 pt, Mixed case)

**PL-04061\_2 Stadium / not intact (area)** Condition of Facility [FUN] = (Abandoned [2], Damaged [13], Destroyed [3], Dismantled [4], Under Construction [1])

Label String: [Name] "Stadium" "["[Condition of Facility]""]  
 Characteristics: 1, 1, 22, 22, 22  
 1 (Black, Condensed, 6 pt, Mixed case)  
 22 (Black, Condensed, 6 pt, Lower case)

**Symbol Samples**



**Stadium / non-obstruction / intact (point)**



Symbol Graphic

Symbol Placement Instructions: Origin: Center of symbol  
 Symbol Type: Simple

Component Ref #: P00006      Component Type: Point - Simple      Color Token: Black  
 Description: Black filled square with all sides 0.8mm  
[Parameters:](#)  
 Length: 0.8mm  
 Note: The component is a square and is filled with the solid color.

**Symbol Rules**

Reference #: Description: Criteria:  
**PS-04062 Stadium / non-obstruction / intact (point)** Height Above Surface Level [HGT] < 46  
 AND Condition of Facility [FUN] = (Fully Functional [6], Unknown [0])

**Label Rules**

Label Placement Rules (see Annex J): LP-3505, LP-4813, LP-9999

Reference #: Description: Criteria:  
**PL-04062\_1 Stadium / non-obstruction / intact (point)** N/A

Label String: [Name] "Stadium"  
 Characteristics: 1, 1  
 1 (Black, Condensed, 6 pt, Mixed case)

**Symbol Samples**

Stadium

Jordan-Hare Stadium

### Stadium / non-obstruction / not intact (point)



Symbol Graphic

Symbol Placement Instructions: Origin: Center of symbol

Symbol Type: Simple

Component Ref #: P00293      Component Type: Point - Shape      Color Token: Black/Black-12  
 Description: Not intact square 0.6mm  
[Parameters:](#)  
 Note: See Annex H for detailed drawing instructions.

#### Symbol Rules

Reference #:	Description:	Criteria:
PS-04933	Stadium / non-obstruction / not intact (point)	Height Above Surface Level [HGT] < 46
	AND	Condition of Facility [FUN] = (Abandoned [2], Damaged [13], Destroyed [3], Dismantled [4], Under Construction [1])

#### Symbol Samples



## Steep Terrain Face (DB010)

Generalization Rules (see Annex J): GA-9999

### Steep Terrain Face / all (line)



Symbol Graphic

Symbol Placement Instructions: The symbol is applied to the geometry of the feature.

Symbol Type: Complex

Repeating Point and Interval: Component P00065 has an initial offset of 0.0mm; after that 0.5mm.

Note: Component P00065 is perpendicular to and on the downhill side of Component L00023.

Component Ref #: L00023      Component Type: Line - Simple      Color Token: Dk-Brown1815  
 Description: Dk-Brown1815 0.2mm Solid Line  
[Parameters:](#)  
 Line Weight: 0.2mm

Component Ref #: P00065      Component Type: Point - Simple      Color Token: Dk-Brown1815  
 Description: Dk-Brown1815 0.5mm length line with a 0.1mm lineweight  
[Parameters:](#)  
 Line Weight: 0.1mm  
 Length: 0.5mm

#### Symbol Rules

Reference #:	Description:	Criteria:
PS-04240	Steep Terrain Face / all (line)	All

#### Label Rules

Label Placement Rules (see Annex J): LP-3630, LP-9999

Reference #: Description: Criteria:  
**PL-04240\_1** **Steep Terrain Face / all (line)** N/A

Label String: [Name]  
 Characteristics: 5  
 5 (Black, Condensed, Italic, 6 pt, Mixed case)

Symbol Samples



**Stopway (GB045)**

Generalization Rules (see Annex J): GA-9999, GC-9994

**Stopway / all (area)**



Symbol Graphic

Symbol Placement Instructions: The symbol is applied to the geometry of the feature.

Symbol Type: Complex

Note: Component L00217 is applied to the perimeter and is filled with Component A00125.

Component Ref #:	A00125	Component Type:	Area - Fill	Color Token:	Blue072-12
Description:	Blue072-12 area fill				
Parameters:					
Screen Angle:	45 degrees				
Screen Percent:	12%				

Component Ref #:	L00217	Component Type:	Line - Simple	Color Token:	Blue072
Description:	Blue072 0.1mm Solid Line				
Parameters:					
Line Weight:	0.1mm				

Symbol Rules

Reference #: Description: Criteria:  
**PS-04633** **Stopway / all (area)** All

Symbol Samples



**Storage Depot (AM010)**

Generalization Rules (see Annex J): GA-9999, GC-9999

**Storage Depot / all (area)**



Symbol Graphic

Symbol Placement Instructions: The symbol is applied to the geometry of the feature.

Symbol Type: Simple

Component Ref #:	L00210	Component Type:	Line - Styled	Color Token:	Black
Description:	Black 0.1mm Dashed line (0.1mm wt, 1.0mm dash, 0.5mm gap)				
<u>Parameters:</u>					
Line Weight:	0.1mm	Dash Length:	1.0mm	Dash Spacing:	0.5mm

Symbol Rules

Reference #:	Description:	Criteria:
PS-04100	Storage Depot / all (area)	All

Label Rules

Label Placement Rules (see Annex J): LP-3506, LP-9999

Reference #:	Description:	Criteria:
PL-04100_1	Storage Depot / on surface (area)	Vertical Relative Location [LOC] = (On Surface [44], Unknown [0])

Label String: "Storage depot"  
 Characteristics: 1  
 1 (Black, Condensed, 6 pt, Mixed case)

Reference #:	Description:	Criteria:
PL-04100_2	Storage Depot / underground (area)	Vertical Relative Location [LOC] = Below Ground Surface [40]

Label String: "Underground storage depot"  
 Characteristics: 1  
 1 (Black, Condensed, 6 pt, Mixed case)

Symbol Samples



Storage depot



Underground storage depot

Storage Depot / all (point)



Symbol Graphic

Symbol Placement Instructions: Origin: Center of symbol

Symbol Type: Simple

Component Ref #:	P00006	Component Type:	Point - Simple	Color Token:	Black
Description:	Black filled square with all sides 0.8mm				
<u>Parameters:</u>					
Length:	0.8mm				
Note:	The component is a square and is filled with the solid color.				

Symbol Rules

Reference #:	Description:	Criteria:
PS-04634	Storage Depot / all (point)	All

Label Rules

Label Placement Rules (see Annex J): LP-3505

Reference #:	Description:	Criteria:
PL-04634_1	Storage Depot / on surface (point)	Vertical Relative Location [LOC] = (On Surface [44], Unknown [0])

Label String: "Storage depot"  
 Characteristics: 1  
 1 (Black, Condensed, 6 pt, Mixed case)

**PL-04634\_2 Storage Depot / underground (point)**

Vertical Relative Location [LOC] = Below Ground Surface [40]

Label String: "Underground storage depot"  
 Characteristics: 1  
 1 (Black, Condensed, 6 pt, Mixed case)

Symbol Samples

■ Storage depot

■ Underground storage depot

**Storage Tank (AM070)**

Generalization Rules (see Annex J): GC-9983, GC-9993

**Storage Tank / non-obstruction / intact (area)**



Symbol Graphic

Symbol Placement Instructions: The symbol is applied to the geometry of the feature.

Symbol Type: Simple

Component Ref #: A00006      Component Type: Area - Fill      Color Token: Black  
 Description: Black solid fill  
 Parameters:  
 Note: The surface geometry is filled with the solid color.

Symbol Rules

Reference #: PS-04115      Description: Storage Tank / non-obstruction / intact (area)      Criteria: Height Above Surface Level [HGT] < 46  
 AND Condition of Facility [FUN] = (Fully Functional [6], Unknown [0])

Label Rules

Label Placement Rules (see Annex J): LP-3505, LP-9999

Reference #:	Description:	Criteria:
PL-04115_1	Storage Tank / non-obstruction / intact / not elevated (area)	Structure Shape [SSC] = (Cylindrical with Flat Top [65], Cylindrical with Framework [59], Horizontal Capped Cylindrical [2], Obelisk [109], Other [999], Pyramidal [12], Spherical [17], Unknown [0], Vertical Capped Cylindrical [4])
	Label String: [Product]	
	Characteristics: 1 1 (Black, Condensed, 6 pt, Mixed case)	
PL-04115_2	Storage Tank / non-obstruction / intact / elevated (area)	Structure Shape [SSC] = Spherical on Column [88]
	Label String: [Product] "(elevated)"	
	Characteristics: 1, 22 1 (Black, Condensed, 6 pt, Mixed case) 22 (Black, Condensed, 6 pt, Lower case)	

Symbol Samples

● Water

● Water (elevated)

**Storage Tank / non-obstruction / not intact (area)**



Symbol Graphic

Symbol Placement Instructions: The symbol is applied to the geometry of the feature.

Symbol Type: Complex

Note: Component L00007 is applied to the perimeter and is filled with Component A00064.

Component Ref #:	A00064	Component Type:	Area - Fill	Color Token:	Black-12
Description:	Black-12 area fill				
Parameters:					
Screen Angle:	45 degrees				
Screen Percent:	12%				

Component Ref #:	L00007	Component Type:	Line - Simple	Color Token:	Black
Description:	Black 0.1mm Solid Line				
Parameters:					
Line Weight:	0.1mm				

**Symbol Rules**

Reference #:	Description:	Criteria:
PS-04935	Storage Tank / non-obstruction / not intact (area)	Height Above Surface Level [HGT] < 46
	AND	Condition of Facility [FUN] = (Abandoned [2], Damaged [13], Destroyed [3], Dismantled [4], Under Construction [1])

**Symbol Samples**



**Storage Tank / non-obstruction / intact / other (point)**



Symbol Graphic

Symbol Placement Instructions: Origin: Center of symbol

Symbol Type: Simple

Component Ref #:	P00053	Component Type:	Point - Simple	Color Token:	Black
Description:	Black 0.8mm diameter filled circle				
Parameters:					
Diameter:	0.8mm				
Note:	The component is a circle and is filled with the solid color.				

**Symbol Rules**

Reference #:	Description:	Criteria:
PS-04116	Storage Tank / non-obstruction / intact / other (point)	Height Above Surface Level [HGT] < 46
	AND	Condition of Facility [FUN] = (Fully Functional [6], Unknown [0])
	AND	( Product [PPO] = (Chemical [16], Gas [45], Oil [75], Other [999], Sewage [101], Water [122], Unknown [0])
	AND	Structure Shape [SSC] = (Cylindrical with Flat Top [65], Cylindrical with Framework [59], Horizontal Capped Cylindrical [2], Obelisk [109], Other [999], Pyramidal [12], Spherical [17], Unknown [0], Vertical Capped Cylindrical [4]) )
	OR	( Product [PPO] = (Chemical [16], Gas [45], Oil [75], Other [999], Petrol [46], Sewage [101], Unknown [0])

AND Structure Shape [SSC] = Spherical on Column [88] ) )

Label Rules

Label Placement Rules (see Annex J): LP-3505, LP-9999

Reference #: Description:

**PL-04116\_1 Storage Tank / non-obstruction / intact / other / not elevated (point)**

Criteria:

Product [PPO] = (Chemical [16], Gas [45], Petrol [46], Oil [75], Other [999], Sewage [101], Unknown [0], Water [122])

AND Structure Shape [SSC] = (Cylindrical with Flat Top [65], Cylindrical with Framework [59], Horizontal Capped Cylindrical [2], Obelisk [109], Other [999], Pyramidal [12], Spherical [17], Unknown [0], Vertical Capped Cylindrical [4])

Label String: [Product]

Characteristics: 1  
1 (Black, Condensed, 6 pt, Mixed case)

**PL-04116\_2 Storage Tank / non-obstruction / intact / other / elevated (point)**

Product [PPO] = (Chemical [16], Gas [45], Petrol [46], Oil [75], Other [999], Sewage [101], Unknown [0])

AND Structure Shape [SSC] = (Spherical on Column [88])

Label String: [Product] "(elevated)"

Characteristics: 1, 22  
1 (Black, Condensed, 6 pt, Mixed case)  
22 (Black, Condensed, 6 pt, Lower case)

Symbol Samples

• Water

• Gas (elevated)

Storage Tank / non-obstruction / not intact (point)



Symbol Graphic

Symbol Placement Instructions: Origin: Center of symbol

Symbol Type: Simple

Component Ref #:	P00291	Component Type:	Point - Shape	Color Token:	Black/Black-12
Description:	Not intact circle 0.8mm				
Parameters:					
Note:	See Annex H for detailed drawing instructions.				

Symbol Rules

Reference #: Description:

**PS-04936 Storage Tank / non-obstruction / not intact (point)**

Criteria:

Height Above Surface Level [HGT] < 46

AND Condition of Facility [FUN] = (Abandoned [2], Damaged [13], Destroyed [3], Dismantled [4], Under Construction [1])

Symbol Samples

o

Storage Tank / non-obstruction / water tower (point)



Symbol Graphic

Symbol Placement Instructions: Origin: Center of open circle

Symbol Type: Simple

Component Ref #:	P00142	Component Type:	Point - Shape	Color Token:	Black/Cyan
Description:	Water tower				
<a href="#">Parameters:</a>					
Note:	See Annex H for detailed drawing instructions.				

### Symbol Rules

Reference #:	Description:	Criteria:
PS-04614	Storage Tank / non-obstruction / water tower (point)	Height Above Surface Level [HGT] < 46
		AND Condition of Facility [FUN] = (Fully Functional [6], Unknown [0])
		AND Product [PPO] = Water [122]
		AND Structure Shape [SSC] = Spherical on Column [88]

### Symbol Samples



## Structural Pile (BD100)

Generalization Rules (see Annex J): GA-9999

### Structural Pile / all (area)



Symbol Graphic

Symbol Placement Instructions: The symbol is applied to the geometry of the feature.

Symbol Type: Complex

Note: Component P00047 is applied to the perimeter with a spacing of 0.8mm, center to center, and the area is filled with Component A00048. This symbol is portrayed in conjunction with the Tidal Water symbol and shall not mask out the Tidal Water symbol.

Component Ref #:	A00048	Component Type:	Area - Fill	Color Token:	Black-12
Description:	Black-12 area fill				
<a href="#">Parameters:</a>					
Screen Angle:	15 degrees				
Screen Percent:	12%				

Component Ref #:	P00047	Component Type:	Point - Simple	Color Token:	Black
Description:	Black 0.25mm diameter filled circle				
<a href="#">Parameters:</a>					
Diameter:	0.25mm				
Note:	The component is a circle and is filled with the solid color.				

### Symbol Rules

Reference #:	Description:	Criteria:
PS-04174	Structural Pile / all (area)	All

### Label Rules

Label Placement Rules (see Annex J): LP-3506

Reference #:	Description:	Criteria:
PL-04174_1	Structural Pile / all (area)	N/A



Label String: "Piles"  
 Characteristics: 1  
 1 (Black, Condensed, 6 pt, Mixed case)

Symbol Samples



Shown with Tidal Water:



Structural Pile / all (point)



Symbol Graphic

Symbol Placement Instructions: Origin: Center of symbol  
 Symbol Type: Simple

Component Ref #: P00103      Component Type: Point - Simple      Color Token: Black  
 Description: Dolphin/Snag/Structural pile  
Parameters:  
 Diameter: 0.8mm  
 Line Weight: 0.15mm  
 Note: The component is an open circle.

Symbol Rules

Reference #: Description: Criteria:  
**PS-04175**    **Structural Pile / all (point)**      All

Label Rules

Label Placement Rules (see Annex J): LP-3505

Reference #: Description: Criteria:  
**PL-04175\_1**    **Structural Pile / all (point)**      N/A

Label String: "Pile"  
 Characteristics: 1  
 1 (Black, Condensed, 6 pt, Mixed case)

Symbol Samples



Shown with Tidal Water:



Surface Bunker (AM060)

Generalization Rules (see Annex J): GC-9985

Surface Bunker / all (point)



Symbol Graphic

Symbol Placement Instructions: Origin: Center of symbol  
 Symbol Type: Simple

Component Ref #: P00283      Component Type: Point - Shape      Color Token: Black/Dk-Brown1815  
 Description: Surface bunker  
[Parameters:](#)  
 Note: See Annex H for detailed drawing instructions.

**Symbol Rules**

Reference #: **PS-04114**      Description: **Surface Bunker / all (point)**      Criteria: All

**Label Rules**

Label Placement Rules (see Annex J): LP-3505, LP-9999

Reference #: **PL-04114\_1**      Description: **Surface Bunker / all (point)**      Criteria: N/A

Label String: [Product]  
 Characteristics: 1  
 1 (Black, Condensed, 6 pt, Mixed case)

**Symbol Samples**



Ammunition

**Survey Point (ZB050)**

**Survey Point / geodetic (point)**



Symbol Graphic

Symbol Placement Instructions: Origin: Center of symbol  
 Symbol Type: Simple

Component Ref #: P00179      Component Type: Point - Shape      Color Token: Black  
 Description: Survey point geodetic  
[Parameters:](#)  
 Note: See Annex H for detailed drawing instructions.

**Symbol Rules**

Reference #: **PS-04491**      Description: **Survey Point / geodetic (point)**      Criteria: Survey Point Type [SUY] = Geodetic Point [5]

**Label Rules**

Label Placement Rules (see Annex J): LP-0073, LP-9999

Reference #: **PL-04491\_1**      Description: **Survey Point / geodetic / normal (point)**      Criteria: N/A

Label String: [Name] [Base Elevation]  
 Characteristics: 21, 25  
 21 (Black, Condensed, 8 pt, Upper case)  
 25 (Black, Condensed, 8 pt, Lower case)

Reference #: **PL-04491\_2**      Description: **Survey Point / geodetic / highest (point)**      Criteria: N/A

Label String: [Name] [Base Elevation]  
 Characteristics: 48, 18  
 48 (Black, Condensed, Bold, 10 pt, Upper case)  
 18 (Black, Condensed, Bold, 10 pt, Lower case)

**Symbol Samples**

△ 1351

Highest on sheet:  
**DAVIDSON** △ 4021

**Survey Point / non-geodetic (point)**



Symbol Graphic

Symbol Placement Instructions: Origin: Center of symbol

Symbol Type: Simple

Component Ref #: P00081      Component Type: Point - Simple      Color Token: Black  
 Description: Black 0.64mm diameter filled circle  
Parameters:  
 Diameter: 0.64mm  
 Note: The component is a circle and is filled with the solid color

**Symbol Rules**

Reference #:	Description:	Criteria:
PS-04492	<b>Survey Point / non-geodetic (point)</b>	Survey Point Type [SUY] = (Astronomic Position [1], Benchmark [2], Cadastral Control Point [3], Camera Station [4], Gravity Point [6], Magnetic Station [7], Other [999], Theodolite Station [8], Tidal Benchmark [9], Unknown [0])

**Label Rules**

Label Placement Rules (see Annex J): LP-0073, LP-4813, LP-9999

Reference #:	Description:	Criteria:
PL-04492_1	<b>Survey Point / non-geodetic / benchmark / normal (point)</b>	Survey Point Type [SUY] = Benchmark [2]
	Label String: [Name] "BM" [Base Elevation]	
	Characteristics: 21, 21, 25 21 (Black, Condensed, 8 pt, Upper case) 25 (Black, Condensed, 8 pt, Lower case)	
PL-04492_2	<b>Survey Point / non-geodetic / known / normal (point)</b>	Survey Point Type [SUY] = (Astronomic Position [1], Cadastral Control Point [3], Camera Station [4], Gravity Point [6], Magnetic Station [7], Theodolite Station [8], Tidal Benchmark [9])
	Label String: [Name] [Survey Point Type] [Base Elevation]	
	Characteristics: 21, 21, 25 21 (Black, Condensed, 8 pt, Upper case) 25 (Black, Condensed, 8 pt, Lower case)	
PL-04492_3	<b>Survey Point / non-geodetic / unknown / normal (point)</b>	Survey Point Type [SUY] = (Other [999], Unknown [0])
	Label String: [Name] [Base Elevation]	
	Characteristics: 21, 25 21 (Black, Condensed, 8 pt, Upper case) 25 (Black, Condensed, 8 pt, Lower case)	
PL-04492_4	<b>Survey Point / non-geodetic / benchmark / highest (point)</b>	Survey Point Type [SUY] = Benchmark [2]
	Label String: [Name] "BM" [Base Elevation]	
	Characteristics: 48, 48, 18 48 (Black, Condensed, Bold, 10 pt, Upper case) 18 (Black, Regular, Bold, 10 pt, Lower case)	
PL-04492_5	<b>Survey Point / non-geodetic / known / highest (point)</b>	Survey Point Type [SUY] = (Astronomic Position [1], Cadastral Control Point [3], Camera Station [4], Gravity Point [6], Magnetic Station [7], Theodolite Station [8], Tidal Benchmark [9])
	Label String: [Name] [Survey Point Type] [Base Elevation]	
	Characteristics: 48, 48, 18 48 (Black, Condensed, Bold, 10 pt, Upper case) 18 (Black, Regular, Bold, 10 pt, Lower case)	

PL-04492\_6 Survey Point / non-geodetic / unknown / highest (point)

Survey Point Type [SUY] = (Other [999], Unknown [0])

Label String: [Name] [Base Elevation]  
 Characteristics: 48, 18  
 48 (Black, Condensed, Bold, 10 pt, Upper case)  
 18 (Black, Regular, Bold, 10 pt, Lower case)

Symbol Samples

BM • 2645

Highest on sheet:  
**MOUNT ADAMS BM • 3742**

**Swamp (ED020)**

Generalization Rules (see Annex J): GA-9999

**Swamp / cypress (area)**



Symbol Graphic

Symbol Placement Instructions: The symbol is applied to the geometry of the feature.

Symbol Type: Complex

Note: Component L00041 is applied to the perimeter and is filled with Components A00007 and A00047. Display level from bottom to top: Component A00007; Component A00047.

Component Ref #:	A00007	Component Type:	Area - Fill	Color Token:	Cyan-31
Description:	Cyan-31 area fill				
Parameters:					
Screen Angle:	45 degrees				
Screen Percent:	31%				
Component Ref #:	A00047	Component Type:	Area - Pattern	Color Token:	Green362
Description:	Green362 Scattered Trees Fill				
Parameters:					
Area Pattern:	AP-44, see Annex I				
Component Ref #:	L00041	Component Type:	Line - Styled	Color Token:	Cyan
Description:	Cyan 0.2mm Dashed Line (0.2mm wt, 2.0mm dash, 0.5mm gap)				
Parameters:					
Line Weight:	0.2mm	Dash Length:	2.0mm	Dash Spacing:	0.5mm

Symbol Rules

Reference #:	Description:	Criteria:
PS-04313	Swamp / cypress (area)	Vegetation Species [VSP] = (Cypress [8], Other [999], Unknown [0])

Label Rules

Label Placement Rules (see Annex J):	LP-0050, LP-3506, LP-9999	
Reference #:	Description:	Criteria:
PL-04313_1	Swamp / cypress (area)	N/A

Label String: [Name]  
 Characteristics: 39  
 39 (Black, Condensed, Italic, 7-16 pt, Upper case)

Symbol Samples

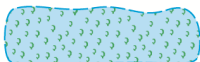

Shown with Land Water Boundary and Tidal Water:



## Swamp / nipa (area)



Symbol Graphic

**Symbol Placement Instructions:** The symbol is applied to the geometry of the feature.

**Symbol Type:** Complex

**Note:** Component L00041 is applied to the perimeter and is filled with Components A00007 and A00024. Display level from bottom to top: Component A00007; Component A00024.

<b>Component Ref #:</b>	A00007	<b>Component Type:</b>	Area - Fill	<b>Color Token:</b>	Cyan-31
<b>Description:</b>	Cyan-31 area fill				
<b>Parameters:</b>					
<b>Screen Angle:</b>	45 degrees				
<b>Screen Percent:</b>	31%				
<b>Component Ref #:</b>	A00024	<b>Component Type:</b>	Area - Pattern	<b>Color Token:</b>	Green362
<b>Description:</b>	Green362 Nipa Fill				
<b>Parameters:</b>					
<b>Area Pattern:</b>	AP-7, see Annex I				
<b>Component Ref #:</b>	L00041	<b>Component Type:</b>	Line - Styled	<b>Color Token:</b>	Cyan
<b>Description:</b>	Cyan 0.2mm Dashed Line (0.2mm wt, 2.0mm dash, 0.5mm gap)				
<b>Parameters:</b>					
<b>Line Weight:</b>	0.2mm	<b>Dash Length:</b>	2.0mm	<b>Dash Spacing:</b>	0.5mm

### Symbol Rules

<b>Reference #:</b>	<b>Description:</b>	<b>Criteria:</b>
PS-04335	Swamp / nipa (area)	Vegetation Species [VSP] = Nipa [22]

### Label Rules

<b>Label Placement Rules (see Annex J):</b>		LP-0050, LP-3506, LP-9999
<b>Reference #:</b>	<b>Description:</b>	<b>Criteria:</b>
PL-04335_1	Swamp / nipa (area)	N/A
	<b>Label String:</b>	[Name]
	<b>Characteristics:</b>	39 39 (Black, Condensed, Italic, 7-16 pt, Upper case)

### Symbol Samples

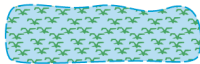

## Swimming Pool (AK170)

**Generalization Rules (see Annex J):** GA-9999, GC-9994, GC-9996

### Swimming Pool / all (area)



Symbol Graphic

**Symbol Placement Instructions:** The symbol is applied to the geometry of the feature.

**Symbol Type:** Complex

**Note:** Component L00007 is applied to the perimeter and is filled with Component A00007.

<b>Component Ref #:</b>	A00007	<b>Component Type:</b>	Area - Fill	<b>Color Token:</b>	Cyan-31
<b>Description:</b>	Cyan-31 area fill				
<b>Parameters:</b>					
<b>Screen Angle:</b>	45 degrees				
<b>Screen Percent:</b>	31%				

Component Ref #: L00007      Component Type: Line - Simple      Color Token: Black  
 Description: Black 0.1mm Solid Line  
Parameters:  
 Line Weight: 0.1mm

Symbol Rules

Reference #: Description: Criteria:  
**PS-04635** **Swimming Pool / all (area)** All

Label Rules

Label Placement Rules (see Annex J): LP-3505

Reference #: Description: Criteria:  
**PL-04635\_1** **Swimming Pool / all (area)** N/A

Label String: "Pool"  
 Characteristics: 1  
 1 (Black, Condensed, 6 pt, Mixed case)

Symbol Samples

□ Pool

**Swimming Pool / all (point)**

Symbol Placement Instructions: Origin: Center of symbol

Symbol Type: Simple



Symbol Graphic

Component Ref #: P00088      Component Type: Point - Shape      Color Token: Black/Cyan-31  
 Description: Swimming pool  
Parameters:  
 Note: See Annex H for detailed drawing instructions.

Symbol Rules

Reference #: Description: Criteria:  
**PS-04098** **Swimming Pool / all (point)** All

Label Rules

Label Placement Rules (see Annex J): LP-3505

Reference #: Description: Criteria:  
**PL-04098\_1** **Swimming Pool / all (point)** N/A

Label String: "Pool"  
 Characteristics: 1  
 1 (Black, Condensed, 6 pt, Mixed case)

Symbol Samples

□ Pool

**Taxiway (GB075)**

Generalization Rules (see Annex J): GA-9999, GC-9994

## Taxiway / all (area)



Symbol Graphic

Symbol Placement Instructions: The symbol is applied to the geometry of the feature.

Symbol Type: Complex

Note: Component L00217 is applied to the perimeter and is filled with Component A00125.

Component Ref #:	A00125	Component Type:	Area - Fill	Color Token:	Blue072-12
Description:	Blue072-12 area fill				
<a href="#">Parameters:</a>					
Screen Angle:	45 degrees				
Screen Percent:	12%				

Component Ref #:	L00217	Component Type:	Line - Simple	Color Token:	Blue072
Description:	Blue072 0.1mm Solid Line				
<a href="#">Parameters:</a>					
Line Weight:	0.1mm				

### Symbol Rules

Reference #:	Description:	Criteria:
PS-04321	Taxiway / all (area)	All

### Symbol Samples



## Test Site (FA100)

Generalization Rules (see Annex J): GA-9999

## Test Site / all (area)



Symbol Graphic

Symbol Placement Instructions: The symbol is applied to the geometry of the feature.

Symbol Type: Simple

Component Ref #:	L00210	Component Type:	Line - Styled	Color Token:	Black
Description:	Black 0.1mm Dashed line (0.1mm wt, 1.0mm dash, 0.5mm gap)				
<a href="#">Parameters:</a>					
Line Weight:	0.1mm	Dash Length:	1.0mm	Dash Spacing:	0.5mm

### Symbol Rules

Reference #:	Description:	Criteria:
PS-04314	Test Site / all (area)	All

### Label Rules

Label Placement Rules (see Annex J): LP-3506, LP-4813, LP-9999

Reference #:	Description:	Criteria:
PL-04314_1	Test Site / intact (area)	N/A

Label String: [Name] "Test site"  
 Characteristics: 1, 1  
 1 (Black, Condensed, 6 pt, Mixed case)

### Symbol Samples

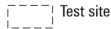

## Thicket (EB020)

Generalization Rules (see Annex J): GA-9999

### Thicket / all (area)

Symbol Placement Instructions: The symbol is applied to the geometry of the feature.

Symbol Type: Simple



Symbol Graphic

Component Ref #:	A00027	Component Type:	Area - Pattern	Color Token:	Green362
Description:	Green362 Scrub / Thicket Fill				
Parameters:	<a href="#">Parameters:</a>				
Area Pattern:	AP-68, see Annex I				

#### Symbol Rules

Reference #:	Description:	Criteria:
PS-04309	Thicket / all (area)	All

#### Symbol Samples

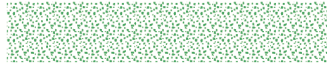

## Tidal Water (BA040)

Generalization Rules (see Annex J): GA-9999

### Tidal Water / all (area)

Symbol Placement Instructions: The symbol is applied to the geometry of the feature.

Symbol Type: Simple



Symbol Graphic

Component Ref #:	A00007	Component Type:	Area - Fill	Color Token:	Cyan-31
Description:	Cyan-31 area fill				
Parameters:	<a href="#">Parameters:</a>				
Screen Angle:	45 degrees				
Screen Percent:	31%				

#### Symbol Rules

Reference #:	Description:	Criteria:
PS-04165	Tidal Water / all (area)	All

#### Label Rules

Label Placement Rules (see Annex J): LP-0050, LP-3506, LP-9999

Reference #:	Description:	Criteria:
PL-04165_1	Tidal Water / all (area)	N/A



Label String: [Name]  
 Characteristics: 59  
 59 (Cyan, Condensed, Italic, 8-18 pt, Upper case)

Symbol Samples



**Tower (AL241)**

**Tower / non-obstruction / communication (point)**



Symbol Graphic

Symbol Placement Instructions: Origin: Center of open circle  
 Symbol Type: Simple

Component Ref #: P00155      Component Type: Point - Shape      Color Token: Black  
 Description: Aerial/tower communication  
Parameters:  
 Note: See Annex H for detailed drawing instructions.

Symbol Rules

Reference #: Description: Criteria:  
**PS-04561** **Tower / non-obstruction / communication (point)** Height Above Surface Level [HGT] < 46  
 AND Tower Type [TTC] = (Cell Tower [19], Communication Tower [18])

Symbol Samples



**Tower / non-obstruction / control (point)**



Symbol Graphic

Symbol Placement Instructions: Origin: Center of symbol  
 Symbol Type: Simple

Component Ref #: P00010      Component Type: Point - Shape      Color Token: Black  
 Description: Located object  
Parameters:  
 Note: See Annex H for detailed drawing instructions.

Symbol Rules

Reference #: Description: Criteria:  
**PS-04133** **Tower / non-obstruction / control (point)** Height Above Surface Level [HGT] < 46  
 AND Tower Type [TTC] = Control Tower [16]

Label Rules

Label Placement Rules (see Annex J): LP-3505

Reference #:	Description:	Criteria:
<b>PL-04133_1</b>	<b>Tower / non-obstruction / control (point)</b>	N/A

Label String: "Control tower"  
 Characteristics: 1  
 1 (Black, Condensed, 6 pt, Mixed case)

Symbol Samples

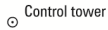

**Tower / non-obstruction / cooling (point)**



Symbol Graphic

Symbol Placement Instructions: Origin: Center of open circle  
 Symbol Type: Simple

Component Ref #:	P00137	Component Type:	Point - Shape	Color Token:	Black
Description:	Cooling tower				
<a href="#">Parameters:</a>					
Note:	See Annex H for detailed drawing instructions.				

Symbol Rules

Reference #:	Description:	Criteria:
<b>PS-04035</b>	<b>Tower / non-obstruction / cooling (point)</b>	Height Above Surface Level [HGT] < 46
	AND	Tower Type [TTC] = Cooling Tower [8]

Symbol Samples



**Tower / non-obstruction / light (point)**



Symbol Graphic

Symbol Placement Instructions: Origin: Center of open circle  
 Symbol Type: Simple

Component Ref #:	P00135	Component Type:	Point - Shape	Color Token:	Black
Description:	Lighthouse				
<a href="#">Parameters:</a>					
Note:	See Annex H for detailed drawing instructions.				

Symbol Rules

Reference #:	Description:	Criteria:
<b>PS-04171</b>	<b>Tower / non-obstruction / light (point)</b>	Height Above Surface Level [HGT] < 46

AND Tower Type [TTC] = Light Tower [5]

Symbol Samples



**Tower / non-obstruction / other (point)**



Symbol Graphic

Symbol Placement Instructions: Origin: Center of open circle

Symbol Type: Simple

Component Ref #: P00141      Component Type: Point - Shape      Color Token: Black  
 Description: Tower non-communication  
 Parameters:  
 Note: See Annex H for detailed drawing instructions.

Symbol Rules

Reference #:	Description:	Criteria:
PS-04096	<b>Tower / non-obstruction / other (point)</b>	Height Above Surface Level [HGT] < 46
	AND	Tower Type [TTC] = (Bridge Tower [1], Drop Tower [23], Fire Tower [12], Guard Tower [21], Industrial Tower [22], Lookout Tower [10], Mine Shaft Superstructure [26], Observation Tower [2], Other [999], Unknown [0])

Symbol Samples



**Tower / non-obstruction / water (point)**



Symbol Graphic

Symbol Placement Instructions: Origin: Center of open circle

Symbol Type: Simple

Component Ref #: P00142      Component Type: Point - Shape      Color Token: Black/Cyan  
 Description: Water tower  
 Parameters:  
 Note: See Annex H for detailed drawing instructions.

Symbol Rules

Reference #:	Description:	Criteria:
PS-04119	<b>Tower / non-obstruction / water (point)</b>	Height Above Surface Level [HGT] < 46
	AND	Tower Type [TTC] = Water Tower [6]

Symbol Samples



## Trail (AP050)

Generalization Rules (see Annex J): GA-9999

### Trail / all (line)

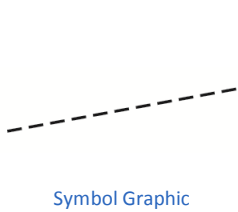

Symbol Placement Instructions: The symbol is applied to the geometry of the feature.

Symbol Type: Simple

Component Ref #:	L00030	Component Type:	Line - Styled	Color Token:	Black
Description:	Black 0.2mm Dashed Line (0.2mm wt, 1.5mm dash, 0.5mm gap)				
Parameters:					
Line Weight:	0.2mm	Dash Length:	1.5mm	Dash Spacing:	0.5mm

### Symbol Rules

Reference #:	Description:	Criteria:
PS-04129	Trail / all (line)	All

### Label Rules

Label Placement Rules (see Annex J): LP-3630

Reference #:	Description:	Criteria:
PL-04129_1	Trail / all (line)	Road Weather Restriction [WTC] = Winter Only [3]

Label String: "Winter only"  
 Characteristics: 10  
 10 (Black, Light Condensed, Italic, 6 pt, Mixed case)

Symbol Samples

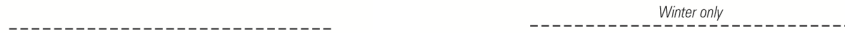

## Training Wall (BB140)

Generalization Rules (see Annex J): GA-9999

### Training Wall / all (area)

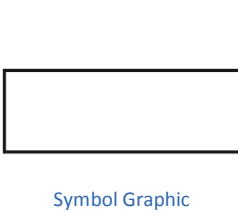

Symbol Placement Instructions: The symbol is applied to the geometry of the feature.

Symbol Type: Simple

Note: This symbol is portrayed in conjunction with the Tidal Water symbol and shall mask out the Tidal Water symbol.

Component Ref #:	L00007	Component Type:	Line - Simple	Color Token:	Black
Description:	Black 0.1mm Solid Line				
Parameters:					
Line Weight:	0.1mm				

Symbol Rules

Reference #: PS-04740 Description: Training Wall / all (area) Criteria: All

Label Rules

Label Placement Rules (see Annex J): LP-3505

Reference #: PL-04740\_1 Description: Training Wall / all (area) Criteria: N/A

Label String: "Jetty"  
 Characteristics: 1  
 1 (Black, Condensed, 6 pt, Mixed case)

Symbol Samples

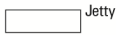

Training Wall / all (line)

Symbol Placement Instructions: The symbol is applied to the geometry of the feature.  
 Symbol Type: Simple



Symbol Graphic

Component Ref #: L00009 Component Type: Line - Simple Color Token: Black  
 Description: Black 0.2mm Solid Line  
 Parameters:  
 Line Weight: 0.2mm

Symbol Rules

Reference #: PS-04741 Description: Training Wall / all (line) Criteria: All

Label Rules

Label Placement Rules (see Annex J): LP-3505

Reference #: PL-04741\_1 Description: Training Wall / all (line) Criteria: N/A

Label String: "Jetty"  
 Characteristics: 1  
 1 (Black, Condensed, 6 pt, Mixed case)

Symbol Samples



Transportation Station (AQ125)

Generalization Rules (see Annex J): GA-9999

Transportation Station / all (area)



Symbol Graphic

**Symbol Placement Instructions:** The symbol is applied to the geometry of the feature.

**Symbol Type:** Simple

<b>Component Ref #:</b>	L00210	<b>Component Type:</b>	Line - Styled	<b>Color Token:</b>	Black
<b>Description:</b>	Black 0.1mm Dashed line (0.1mm wt, 1.0mm dash, 0.5mm gap)				
<u>Parameters:</u>					
<b>Line Weight:</b>	0.1mm	<b>Dash Length:</b>	1.0mm	<b>Dash Spacing:</b>	0.5mm

**Symbol Rules**

Reference #:	Description:	Criteria:
<b>PS-04144</b>	<b>Transportation Station / all (area)</b>	All

**Label Rules**

Label Placement Rules (see Annex J): LP-3506, LP-4813, LP-9950, LP-9999

Reference #:	Description:	Criteria:
<b>PL-04144_1</b>	<b>Transportation Station / intact / type known (area)</b>	Transportation System Type [TRS] = (Aeronautical [1], Aqueduct [2], Bus [4], Canal [5], Maritime [7], Pedestrian [9], Pipeline [10], Railway [12]) AND Condition of Facility [FUN] = (Fully Functional [6], Unknown [0])
	<b>Label String:</b> [Name] [Transportation System Type] "Station" <b>Characteristics:</b> 1, 1, 1 1 (Black, Condensed, 6 pt, Mixed case)	
<b>PL-04144_2</b>	<b>Transportation Station / intact / type unknown (area)</b>	Transportation System Type [TRS] = (Not Applicable [998], Other [999], Road [13], Unknown [0]) AND Condition of Facility [FUN] = (Fully Functional [6], Unknown [0])
	<b>Label String:</b> [Name] "Station" <b>Characteristics:</b> 1, 1 1 (Black, Condensed, 6 pt, Mixed case)	
<b>PL-04144_3</b>	<b>Transportation Station / not intact / type known (area)</b>	Transportation System Type [TRS] = (Aeronautical [1], Aqueduct [2], Bus [4], Canal [5], Maritime [7], Pedestrian [9], Pipeline [10], Railway [12]) AND Condition of Facility [FUN] = (Abandoned [2], Damaged [13], Destroyed [3], Dismantled [4], Under Construction [1])
	<b>Label String:</b> [Name] [Transportation System Type] "Station" "["[Condition of Facility]""]" <b>Characteristics:</b> 1, 1, 1, 22, 22, 22 1 (Black, Condensed, 6 pt, Mixed case) 22 (Black, Condensed, 6 pt, Lower case)	
<b>PL-04144_4</b>	<b>Transportation Station / not intact / type unknown (area)</b>	Transportation System Type [TRS] = (Not Applicable [998], Other [999], Road [13], Unknown [0]) AND Condition of Facility [FUN] = (Abandoned [2], Damaged [13], Destroyed [3], Dismantled [4], Under Construction [1])
	<b>Label String:</b> [Name] "Station" "["[Condition of Facility]""]" <b>Characteristics:</b> 1, 1, 22, 22, 22 1 (Black, Condensed, 6 pt, Mixed case) 22 (Black, Condensed, 6 pt, Lower case)	

**Symbol Samples**



**Transportation Station / intact / railway (point)**



Symbol Graphic

Symbol Placement Instructions: Origin: Center of symbol

Symbol Type: Simple

Note: The symbol is centered on top of and aligned with the associated Railway or Railway Sidetrack symbol.

Component Ref #:	P00079	Component Type:	Point - Shape	Color Token:	Black
Description:	Railway station				
Parameters:					
Note:	See Annex H for detailed drawing instructions.				

Symbol Rules

Reference #:	Description:	Criteria:
PS-04408	Transportation Station / intact / railway (point)	Condition of Facility [FUN] = (Fully Functional [6], Unknown [0])
	AND	Transportation System Type [TRS] = Railway [12]

Label Rules

Label Placement Rules (see Annex J): LP-3505, LP-9999

Reference #:	Description:	Criteria:
PL-04408_1	Transportation Station / intact / railway (point)	N/A

Label String: [Name]  
 Characteristics: 1  
 1 (Black, Condensed, 6 pt, Mixed case)

Symbol Samples



Transportation Station / intact / other (point)



Symbol Graphic

Symbol Placement Instructions: Origin: Center of symbol

Symbol Type: Simple

Component Ref #:	P00006	Component Type:	Point - Simple	Color Token:	Black
Description:	Black filled square with all sides 0.8mm				
Parameters:					
Length:	0.8mm				
Note:	The component is a square and is filled with the solid color.				

Symbol Rules

Reference #:	Description:	Criteria:
PS-04427	Transportation Station / intact / other (point)	Condition of Facility [FUN] = (Fully Functional [6], Unknown [0])
	AND	Transportation System Type [TRS] = (Aeronautical [1], Aqueduct [2], Bus [4], Canal [5], Maritime [7], Not Applicable [998], Other [999], Pedestrian [9], Pipeline [10], Road [13], Unknown [0])

Label Rules

Label Placement Rules (see Annex J): LP-3505, LP-9999

Reference #:	Description:	Criteria:
PL-04427_1	Transportation Station / intact / other (point)	N/A

Label String: [Name]

Characteristics: 1  
1 (Black, Condensed, 6 pt, Mixed case)

Symbol Samples

Foggy Bottom Station

Point of Rocks Water Transport

Transportation Station / not intact (point)



Symbol Graphic

Symbol Placement Instructions: Origin: Center of symbol

Symbol Type: Simple

Component Ref #:	P00173	Component Type:	Point - Shape	Color Token:	Black/Black-12
Description:	Not intact square 0.8mm				
<a href="#">Parameters:</a>					
Note:	See Annex H for detailed drawing instructions.				

Symbol Rules

Reference #:	Description:	Criteria:
PS-04241	Transportation Station / not intact (point)	Condition of Facility [FUN] = (Abandoned [2], Damaged [13], Destroyed [3], Dismantled [4], Under Construction [1])

Symbol Samples

Tundra (BJ110)

Generalization Rules (see Annex J): GA-9999

Tundra / all (area)

TUNDRA

Symbol Graphic

Symbol Placement Instructions: Text label only. No graphic parameters

Symbol Type: Simple

Symbol Rules

Reference #:	Description:	Criteria:
PS-04233	Tundra / all (area)	All

Label Rules

Label Placement Rules (see Annex J): LP-0050, LP-3506

Reference #:	Description:	Criteria:
PL-04233_1	Tundra / all (area)	N/A

Label String: "TUNDRA"

Characteristics: 39  
39 (Black, Condensed, Italic, 7-16 pt, Upper case)



TUNDRA

## Tunnel (AQ130)

Generalization Rules (see Annex J): GA-9999, GC-9979, GC-9992

### Tunnel / road, taxiway (line)

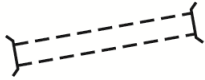

Symbol Graphic

**Symbol Placement Instructions:** The symbol is applied to the geometry of the feature.

**Symbol Type:** Complex

**Note:** Component P00073 is fixed at the start and end of Component L00213 and is centered perpendicular to the lines, with each angled element facing away.

<b>Component Ref #:</b>	L00213	<b>Component Type:</b>	Line - Styled	<b>Color Token:</b>	Black
<b>Description:</b>	Two parallel Black 0.2mm Dashed Lines (0.2mm wt, 1.0mm dash, 0.5mm gap) spaced 1.3mm apart				
<b>Parameters:</b>					
<b>Line Weight:</b>	0.2mm	<b>Dash Length:</b>	1.0mm	<b>Dash Spacing:</b>	0.5mm
<b>Note:</b>	The two parallel Black 0.2mm Dashed Lines are spaced 1.3mm apart from center to center				

<b>Component Ref #:</b>	P00073	<b>Component Type:</b>	Point - Shape	<b>Color Token:</b>	Black
<b>Description:</b>	Tunnel entrance not water				
<b>Parameters:</b>					
<b>Note:</b>	See Annex H for detailed drawing instructions.				

### Symbol Rules

<b>Reference #:</b>	<b>Description:</b>	<b>Criteria:</b>
PS-04149	Tunnel / road, taxiway (line)	Transportation System Type [TRS] = (Aeronautical [1], Bus [4], Road [13])

### Label Rules

Label Placement Rules (see Annex J): LP-3505, LP-9950, LP-9999

<b>Reference #:</b>	<b>Description:</b>	<b>Criteria:</b>
PL-04149_1	Tunnel / road, taxiway / intact (line)	Condition of Facility [FUN] = (Fully Functional [6], Unknown [0])
	<b>Label String:</b> [Name]	
	<b>Characteristics:</b> 1 1 (Black, Condensed, 6 pt, Mixed case)	
PL-04149_2	Tunnel / road, taxiway / not intact (line)	Condition of Facility [FUN] = (Abandoned [2], Damaged [13], Destroyed [3], Dismantled [4], Under Construction [1])
	<b>Label String:</b> [Name] "["[Condition of Facility]"	
	<b>Characteristics:</b> 1, 22, 22, 22 1 (Black, Condensed, 6 pt, Mixed case) 22 (Black, Condensed, 6 pt, Lower case)	

### Symbol Samples



Shown with Road:

Salt Creek Tunnel

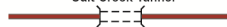

### Tunnel / railway, pedestrian, other (line)

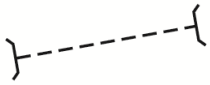

Symbol Graphic

**Symbol Placement Instructions:** The symbol is applied to the geometry of the feature.

**Symbol Type:** Complex

**Note:** Component P00073 is fixed at the start and end of Component L00031 and is centered perpendicular to the line, with each angled element facing away.

<b>Component Ref #:</b>	L00031	<b>Component Type:</b>	Line - Styled	<b>Color Token:</b>	Black
<b>Description:</b>	Black 0.2mm Dashed Line (0.2mm wt, 1.0mm dash, 0.5mm gap)				
<b>Parameters:</b>					
<b>Line Weight:</b>	0.2mm	<b>Dash Length:</b>	1.0mm	<b>Dash Spacing:</b>	0.5mm
<b>Component Ref #:</b>	P00073	<b>Component Type:</b>	Point - Shape	<b>Color Token:</b>	Black
<b>Description:</b>	Tunnel entrance not water				
<b>Parameters:</b>					
<b>Note:</b>	See Annex H for detailed drawing instructions.				

### Symbol Rules

Reference #:	Description:	Criteria:
<b>PS-04146</b>	<b>Tunnel / railway, pedestrian, other (line)</b>	Transportation System Type [TRS] = (Not Applicable [998], Other [999], Pedestrian [9], Pipeline [10], Railway [12], Unknown [0])

### Label Rules

Reference #:	Description:	Criteria:
<b>LP-3505, LP-9950, LP-9999</b>	Label Placement Rules (see Annex J):	
<b>PL-04146_1</b>	<b>Tunnel / railway, pedestrian, other / intact (line)</b>	Condition of Facility [FUN] = (Fully Functional [6], Unknown [0])
	<b>Label String:</b> [Name]	
	<b>Characteristics:</b> 1 1 (Black, Condensed, 6 pt, Mixed case)	
<b>PL-04146_2</b>	<b>Tunnel / railway, pedestrian, other / not intact (line)</b>	Condition of Facility [FUN] = (Abandoned [2], Damaged [13], Destroyed [3], Dismantled [4], Under Construction [1])
	<b>Label String:</b> [Name] "["[Condition of Facility]"	
	<b>Characteristics:</b> 1, 22, 22, 22 1 (Black, Condensed, 6 pt, Mixed case) 22 (Black, Condensed, 6 pt, Lower case)	

### Symbol Samples

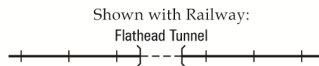

## Tunnel / inland waterway / wide (line)



Symbol Graphic

**Symbol Placement Instructions:** The symbol is applied to the geometry of the feature.

**Symbol Type:** Complex

**Note:** Component P00074 is fixed at the start and end of Component L00214 and is centered perpendicular to the lines, with each angled element facing away.

<b>Component Ref #:</b>	L00214	<b>Component Type:</b>	Line - Styled	<b>Color Token:</b>	Cyan
<b>Description:</b>	Two parallel Cyan 0.2mm Dashed Lines (0.2mm wt, 1.0mm dash, 0.5mm gap) spaced 1.3mm apart				
<b>Parameters:</b>					
<b>Line Weight:</b>	0.2mm	<b>Dash Length:</b>	1.0mm	<b>Dash Spacing:</b>	0.5mm
<b>Note:</b>	The two parallel Cyan 0.2mm Dashed Lines are spaced 1.3mm apart from center to center				

Component Ref #: P00074      Component Type: Point - Shape      Color Token: Cyan  
 Description: Tunnel entrance water  
Parameters:  
 Note: See Annex H for detailed drawing instructions.

**Symbol Rules**

Reference #: Description: Criteria:  
**PS-04147** Tunnel / inland waterway / wide (line)      Transportation System Type [TRS] = (Aqueduct [2], Canal [5], Maritime [7])  
 AND      Width [WID] >= 25

**Label Rules**

Label Placement Rules (see Annex J): LP-3505, LP-9950, LP-9999

Reference #: Description: Criteria:  
**PL-04147\_1** Tunnel / inland waterway / wide / intact (line)      Condition of Facility [FUN] = (Fully Functional [6], Unknown [0])

Label String: [Name]  
 Characteristics: 14  
 14 (Cyan, Condensed, 6 pt, Mixed case)

**PL-04147\_2** Tunnel / inland waterway / wide / not intact (line)      Condition of Facility [FUN] = (Abandoned [2], Damaged [13], Destroyed [3], Dismantled [4], Under Construction [1])

Label String: [Name] "["[Condition of Facility]"  
 Characteristics: 14, 93, 93, 93  
 14 (Cyan, Condensed, 6 pt, Mixed case)  
 93 (Cyan, Condensed, 6 pt, Lower case)

**Symbol Samples**



**Tunnel / inland waterway / narrow (line)**



Symbol Graphic

Symbol Placement Instructions: The symbol is applied to the geometry of the feature.  
 Symbol Type: Complex

Note: Component P00074 is fixed at the start and end of Component L00040 and is centered perpendicular to the line, with each angled element facing away.

Component Ref #: L00040      Component Type: Line - Styled      Color Token: Cyan  
 Description: Cyan 0.2mm Dashed Line (0.2mm wt, 1.0mm dash, 0.5mm gap)  
Parameters:  
 Line Weight: 0.2mm      Dash Length: 1.0mm      Dash Spacing: 0.5mm

Component Ref #: P00074      Component Type: Point - Shape      Color Token: Cyan  
 Description: Tunnel entrance water  
Parameters:  
 Note: See Annex H for detailed drawing instructions.

**Symbol Rules**

Reference #: Description: Criteria:  
**PS-04148** Tunnel / inland waterway / narrow (line)      Transportation System Type [TRS] = (Aqueduct [2], Canal [5], Maritime [7])  
 AND      Width [WID] < 25

**Label Rules**

Label Placement Rules (see Annex J): LP-3505, LP-9950, LP-9999

Reference #: Description: Criteria:  
**PL-04148\_1** Tunnel / inland waterway / narrow / intact (line)      Condition of Facility [FUN] = (Fully Functional [6], Unknown [0])

Label String: [Name]  
 Characteristics: 14  
 14 (Cyan, Condensed, 6 pt, Mixed case)

**PL-04148\_2 Tunnel / inland waterway / narrow / not intact (line)**

Condition of Facility [FUN] = (Abandoned [2], Damaged [13], Destroyed [3], Dismantled [4], Under Construction [1])

Label String: [Name] "["[Condition of Facility]""]  
 Characteristics: 14, 93, 93, 93  
 14 (Cyan, Condensed, 6 pt, Mixed case)  
 93 (Cyan, Condensed, 6 pt, Lower case)

Symbol Samples

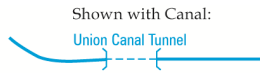

**Vanishing Point (BH145)**

**Vanishing Point / disappearing (point)**



Symbol Graphic

Symbol Placement Instructions: Origin: Center of open circle  
 Symbol Type: Simple

Note: The symbol connects to the end of the associated River feature. The open circle portion of symbol is oriented downstream.

Component Ref #:	P00028	Component Type:	Point - Shape	Color Token:	Cyan
Description:	Vanishing point disappearing				
Parameters:					
Note:	See Annex H for detailed drawing instructions.				

Symbol Rules

Reference #:	Description:	Criteria:
PS-04206	Vanishing Point / disappearing (point)	Watercourse Sink Type [WST] = Disappearing [2]

Symbol Samples

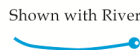

**Vanishing Point / dissipating (point)**



Symbol Graphic

Symbol Placement Instructions: Origin: Apex of "V"  
 Symbol Type: Simple

Note: The apex of the symbol connects to the end of the associated River feature. The open side of the "V" is oriented downstream.

Component Ref #:	P00059	Component Type:	Point - Shape	Color Token:	Cyan
Description:	Vanishing point dissipating				
Parameters:					
Note:	See Annex H for detailed drawing instructions.				

Symbol Rules

Reference #:	Description:	Criteria:
PS-04207	Vanishing Point / dissipating (point)	Watercourse Sink Type [WST] = (Dissipating [1], Unknown [0])

Symbol Samples



Vehicle Lot (AQ140)

Generalization Rules (see Annex J): GA-9999

Vehicle Lot / all (area)



Symbol Graphic

Symbol Placement Instructions: The symbol is applied to the geometry of the feature.

Symbol Type: Simple

Note: The "P" is centered within the surface geometry of the feature.

Component Ref #:	L00210	Component Type:	Line - Styled	Color Token:	Black
Description:	Black 0.1mm Dashed line (0.1mm wt, 1.0mm dash, 0.5mm gap)				
Parameters:					
Line Weight:	0.1mm	Dash Length:	1.0mm	Dash Spacing:	0.5mm

Symbol Rules

Reference #:	Description:	Criteria:
PS-04151	Vehicle Lot / all (area)	All

Label Rules

Label Placement Rules (see Annex J): LP-3506

Reference #:	Description:	Criteria:
PL-04151_1	Vehicle Lot / all (area)	N/A

Label String: "P"  
 Characteristics: 1  
 1 (Black, Condensed, 6 pt, Mixed case)

Symbol Samples



Vertical Obstruction (No Code)

Vertical Obstruction / single (point)



Symbol Graphic

Symbol Placement Instructions: Origin: Center of dot

Symbol Type: Simple

Note: If the symbol is moved away from the associated dot element, a Leader Line/aero blue is added connecting the symbol and the dot.

Component Ref #: P00008      Component Type: Point - Shape      Color Token: Blue072  
 Description: Vertical obstruction  
Parameters:  
 Note: See Annex H for detailed drawing instructions.

**Symbol Rules**

<b>Reference #:</b>	<b>Description:</b>	<b>Criteria:</b>
<b>PS-04512</b>	<b>Vertical Obstruction / single (point)</b>	Height Above Surface Level [HGT] >= 46
	AND	Feature [Code] = (Bridge [AQ040], Catalytic Cracker [AC020], Communication Station [AT050], Crane [AF040], Dam [BIO20], Dish Aerial [AT010], Disposal Site [AB000], Electric Power Station [AD010], Flare Pipe [AF070], Fortification [AH050], General Building [AL015], Grain Elevator [AM030], Grain Storage Structure [AM020], Memorial Monument [AL130], Mineral Pile [AM040], Mooring Mast [AQ110], Offshore Platform [BD110], Processing Facility [AC000], Rig [AA040], Smokestack [AF010], Stadium [AK160], Storage Tank [AM070], Tower [AL241], Water Intake Tower [BIO50], Wind Turbine [AJ051], Windmill [AJ050])

**Label Rules**

Label Placement Rules (see Annex J): LP-9992

<b>Reference #:</b>	<b>Description:</b>	<b>Criteria:</b>
<b>PS-04512_1</b>	<b>Vertical Obstruction / single / onshore (point)</b>	Structures that are located onshore
	<b>Label String:</b>	[Feature Name] [Highest Elevation] "("[Height Above Surface Level]")"
	<b>Characteristics:</b>	15 46 95, 95, 95 15 (Blue072, Condensed, 6 pt, Mixed case) 46 (Blue072, Condensed, Bold, 6 pt, Lower case) 95 (Blue072, Condensed, 6 pt, Lower case)

<b>PS-04512_2</b>	<b>Vertical Obstruction / single / offshore (point)</b>	Structures that are located offshore
	<b>Label String:</b>	[Feature Name] "("[Height Above Surface Level]")"
	<b>Characteristics:</b>	15 95, 95, 95 15 (Blue072, Condensed, 6 pt, Mixed case) 95 (Blue072, Condensed, 6 pt, Lower case)

**Symbol Samples**



**Vertical Obstruction / multiple (point)**



Symbol Graphic

Symbol Placement Instructions: Origin: Center of dot

Symbol Type: Simple

Note: If the symbol is moved away from the associated dot element, a Leader Line/aero blue is added connecting the symbol and the dot.

Component Ref #: P00101      Component Type: Point - Shape      Color Token: Blue072  
 Description: Vertical obstruction multiple  
Parameters:  
 Note: See Annex H for detailed drawing instructions.

**Symbol Rules**

<b>Reference #:</b>	<b>Description:</b>	<b>Criteria:</b>
<b>PS-04513</b>	<b>Vertical Obstruction / multiple (point)</b>	Use this symbol to replace a group of single vertical obstruction symbols as needed.

Label Rules

Label Placement Rules (see Annex J): LP-9992

Reference #: Description: Criteria:  
**PS-04513\_1 Vertical Obstruction / multiple / onshore / same (point)** Same structures that are located onshore

Label String: [Feature Name]"s"  
 [Highest Elevation]  
 "["[Height Above Surface Level]""]"  
 Characteristics: 15, 95  
 46  
 95, 95, 95  
 15 (Blue072, Condensed, 6 pt, Mixed case)  
 46 (Blue072, Condensed, Bold, 6 pt, Lower case)  
 95 (Blue072, Condensed, 6 pt, Lower case)

**PS-04513\_2 Vertical Obstruction / multiple / onshore / different (point)** Different structures that are located onshore

Label String: [Highest Elevation]  
 "["[Height Above Surface Level]""]"  
 Characteristics: 46  
 95, 95, 95  
 46 (Blue072, Condensed, Bold, 6 pt, Lower case)  
 95 (Blue072, Condensed, 6 pt, Lower case)

**PS-04513\_3 Vertical Obstruction / multiple / offshore / same (point)** Structures that are located offshore

Label String: [Feature Name]"s"  
 "["[Height Above Surface Level]""]"  
 Characteristics: 15, 95  
 95, 95, 95  
 15 (Blue072, Condensed, 6 pt, Mixed case)  
 95 (Blue072, Condensed, 6 pt, Lower case)

**PS-04513\_4 Vertical Obstruction / multiple / offshore / different (point)** Different structures that are located offshore

Label String: "["[Height Above Surface Level]""]"  
 Characteristics: 95, 95, 95  
 95 (Blue072, Condensed, 6 pt, Lower case)

Symbol Samples



Vineyard (EA050)

Generalization Rules (see Annex J): GA-9999

Vineyard / all (area)



Symbol Graphic

Symbol Placement Instructions: The symbol is applied to the geometry of the feature.

Symbol Type: Simple

Component Ref #: A00029 Component Type: Area - Pattern Color Token: Green362  
 Description: Green362 Vineyard / Hops Fill  
 Parameters:  
 Area Pattern: AP-77, see Annex I

Symbol Rules

Reference #: Description: Criteria:

PS-04306 Vineyard / all (area) All

Label Rules

Label Placement Rules (see Annex J): LP-3506, LP-9999

Reference #:	Description:	Criteria:
PL-04306_1	Vineyard / all (area)	N/A

Label String: [Name]  
 Characteristics: 1  
 1 (Black, Condensed, 6 pt, Mixed case)

Symbol Samples



Void Collection Area (ZD020)

Generalization Rules (see Annex J): GA-9999

Void Collection Area / all (area)



Symbol Graphic

Symbol Placement Instructions: The symbol is applied to the geometry of the feature.  
 Symbol Type: Simple

Component Ref #:	L00210	Component Type:	Line - Styled	Color Token:	Black
Description:	Black 0.1mm Dashed line (0.1mm wt, 1.0mm dash, 0.5mm gap)				
Parameters:					
Line Weight:	0.1mm	Dash Length:	1.0mm	Dash Spacing:	0.5mm

Symbol Rules

Reference #:	Description:	Criteria:
PS-04319	Void Collection Area / all (area)	All

Label Rules

Label Placement Rules (see Annex J): LP-0050, LP-3506

Reference #:	Description:	Criteria:
PL-04319_1	Void Collection Area / all (area)	N/A

Label String: "DATA INCOMPLETE"  
 Characteristics: 40  
 40 (Black, Condensed, 6-16 pt, Upper case)

Symbol Samples



Volcano (DB180)

Generalization Rules (see Annex J): GA-9999

Volcano / all (area)



[NAM]

Symbol Graphic

Symbol Placement Instructions: Text label only. No graphic parameters

Symbol Type: Simple

Symbol Rules

Reference #:	Description:	Criteria:
PS-04941	Volcano / all (area)	All

Label Rules

Label Placement Rules (see Annex J): LP-0050, LP-3506, LP-9999

Reference #:	Description:	Criteria:
PL-04941_1	Volcano / all (area)	N/A

Label String: [Name]  
 Characteristics: 7  
 7 (Black, Condensed, Italic 7-10 pt, Mixed case)

Symbol Samples

*Mount Rainier*

Volcano / all (point)



Symbol Graphic

Symbol Placement Instructions: Origin: Center of symbol

Symbol Type: Simple

Component Ref #:	P00064	Component Type:	Point - Shape	Color Token:	Dk-Brown1815
Description:	Volcano				
Parameters:					
Note:	See Annex H for detailed drawing instructions.				

Symbol Rules

Reference #:	Description:	Criteria:
PS-04667	Volcano / all (point)	All

Label Rules

Label Placement Rules (see Annex J): LP-3505, LP-9999

Reference #:	Description:	Criteria:
PL-04667_1	Volcano / all (point)	N/A

Label String: [Name]  
 Characteristics: 5  
 5 (Black, Condensed, Italic 6 pt, Mixed case)

Symbol Samples



*Pu'u ka Pele*

## Wall (AL260)

Generalization Rules (see Annex J): GA-9999

### Wall / all (line)



Symbol Graphic

**Symbol Placement Instructions:** The symbol is applied to the geometry of the feature.

**Symbol Type:** Complex

**Repeating Point and Interval:** Component P00149 has an initial offset of 1.0mm; after that 2.0mm.

**Note:** Longest axis of Component P00149 is centered on and perpendicular to L00008.

<b>Component Ref #:</b>	L00008	<b>Component Type:</b>	Line - Simple	<b>Color Token:</b>	Black
<b>Description:</b>	Black 0.15mm Solid Line				
<b>Parameters:</b>					
<b>Line Weight:</b>	0.15mm				

<b>Component Ref #:</b>	P00149	<b>Component Type:</b>	Point - Simple	<b>Color Token:</b>	Black
<b>Description:</b>	Black 0.35mm length line with a 0.45mm lineweight				
<b>Parameters:</b>					
<b>Line Weight:</b>	0.45mm				
<b>Length:</b>	0.35mm				

### Symbol Rules

<b>Reference #:</b>	<b>Description:</b>	<b>Criteria:</b>
PS-04099	Wall / all (line)	All

### Symbol Samples



## Water Aerodrome (GB065)

Generalization Rules (see Annex J): GA-9999

### Water Aerodrome / all (area)



Symbol Graphic

**Symbol Placement Instructions:** The symbol is applied to the geometry of the feature.

**Symbol Type:** Complex

**Note:** Component L00210 is applied to the perimeter and component P00257 shall be placed entirely within the associated Lake, Reservoir, River, or Tidal Water feature. Component L00210 shall be suppressed where coincident with Component P00257. Component P00257 shall not be shown if there is an associated Seaplane Run.

<b>Component Ref #:</b>	L00210	<b>Component Type:</b>	Line - Styled	<b>Color Token:</b>	Black
<b>Description:</b>	Black 0.1mm Dashed line (0.1mm wt, 1.0mm dash, 0.5mm gap)				
<b>Parameters:</b>					
<b>Line Weight:</b>	0.1mm	<b>Dash Length:</b>	1.0mm	<b>Dash Spacing:</b>	0.5mm

<b>Component Ref #:</b>	P00257	<b>Component Type:</b>	Point - Shape	<b>Color Token:</b>	Blue072
<b>Description:</b>	Water aerodrome				
<b>Parameters:</b>					
<b>Note:</b>	See Annex H for detailed drawing instructions.				

### Symbol Rules

<b>Reference #:</b>	<b>Description:</b>	<b>Criteria:</b>
PS-04569	Water Aerodrome / all (area)	All

### Label Rules

Label Placement Rules (see Annex J): LP-3506, LP-4813, LP-9950, LP-9990, LP-9999

Reference #: Description: Criteria:  
**PL-04569\_1 Water Aerodrome / intact (area)** Condition of Facility [FUN] = (Fully Functional [6], Unknown [0])

Label String: [Name] [ICAO Location Indicator] "Seaplane base"  
 [Aerodrome Elevation]  
 Characteristics: 24, 29, 24  
 26  
 24 (Blue072, Condensed, 7 pt, Mixed case)  
 26 (Blue072, Condensed, 7 pt, Lower case)  
 29 (Blue072, Condensed, 7 pt, Upper case)

**PL-04569\_2 Water Aerodrome / not intact (area)** Condition of Facility [FUN] = (Abandoned [2], Damaged [13], Destroyed [3], Dismantled [4], Under Construction [1])

Label String: [Name] [ICAO Location Indicator] "Seaplane base"  
 "["[Condition of Facility]""]  
 [Aerodrome Elevation]  
 Characteristics: 24, 29, 24  
 26, 26, 26  
 26  
 24 (Blue072, Condensed, 7 pt, Mixed case)  
 26 (Blue072, Condensed, 7 pt, Lower case)  
 29 (Blue072, Condensed, 7 pt, Upper case)

Symbol Samples

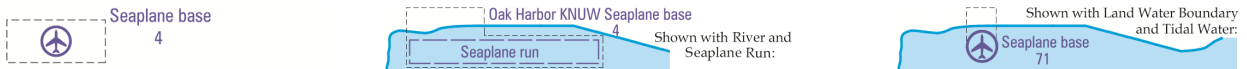

Water Aerodrome / all (point)



Symbol Graphic

Symbol Placement Instructions: Origin: Center of symbol  
 Symbol Type: Simple

Note: Component P00257 shall be placed entirely within the associated Lake, Reservoir, River, or Tidal Water feature. Component P00257 shall not be shown if there is an associated Seaplane Run (but retain labeling).

Component Ref #:	P00257	Component Type:	Point - Shape	Color Token:	Blue072
Description:	Water aerodrome				
Parameters:					
Note:	See Annex H for detailed drawing instructions.				

Symbol Rules

Reference #: Description: Criteria:  
**PS-04318 Water Aerodrome / all (point)** All

Label Rules

Label Placement Rules (see Annex J): LP-3505, LP-4813, LP-9950, LP-9990, LP-9999

Reference #: Description: Criteria:  
**PL-04318\_1 Water Aerodrome / intact (point)** Condition of Facility [FUN] = (Fully Functional [6], Unknown [0])

Label String: [Name] [ICAO Location Indicator] "Seaplane base"  
 [Aerodrome Elevation]  
 Characteristics: 24, 29, 24  
 26  
 24 (Blue072, Condensed, 7 pt, Mixed case)  
 26 (Blue072, Condensed, 7 pt, Lower case)  
 29 (Blue072, Condensed, 7 pt, Upper case)

**PL-04318\_2 Water Aerodrome / not intact (point)**

Condition of Facility [FUN] = (Abandoned [2], Damaged [13], Destroyed [3], Dismantled [4], Under Construction [1])

Label String: [Name] [ICAO Location Indicator] "Seaplane base"  
 "[Condition of Facility]"  
 [Aerodrome Elevation]

Characteristics: 24, 29, 24  
 26, 26, 26  
 26  
 24 (Blue072, Condensed, 7 pt, Mixed case)  
 26 (Blue072, Condensed, 7 pt, Lower case)  
 29 (Blue072, Condensed, 7 pt, Upper case)

Symbol Samples

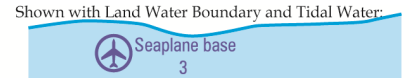

**Water Gate (BI041)**

Generalization Rules (see Annex J): GA-9999

**Water Gate / all (line)**

Symbol Placement Instructions: The symbol is applied to the geometry of the feature.  
 Symbol Type: Simple

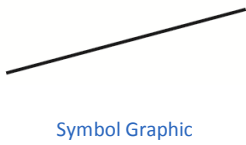

Component Ref #:	L00009	Component Type:	Line - Simple	Color Token:	Black
Description:	Black 0.2mm Solid Line				
Parameters:	Line Weight: 0.2mm				

Symbol Rules

Reference #:	Description:	Criteria:
PS-04769	Water Gate / all (line)	All

Label Rules

Label Placement Rules (see Annex J): LP-3505

Reference #:	Description:	Criteria:
PL-04769_1	Water Gate / all (line)	N/A

Label String: "Water gate"  
 Characteristics: 1  
 1 (Black, Condensed, 6 pt, Mixed case)

Symbol Samples

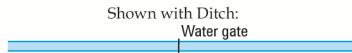
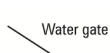

**Water Gate / all (point)**



Symbol Graphic

Symbol Placement Instructions: Origin: Apex of "V"

Symbol Type: Simple

Note: Component P00105 is centered on the associated drainage symbol with apex pointing upstream.

Component Ref #:	P00105	Component Type:	Point - Shape	Color Token:	Black
Description:	Lock/pedestrian bridge/sluiice gate "V"				
<a href="#">Parameters:</a>					
Note:	See Annex H for detailed drawing instructions.				

### Symbol Rules

Reference #:	Description:	Criteria:
PS-04770	Water Gate / all (point)	All

### Symbol Samples



## Water Intake Tower (BI050)

### Water Intake Tower / non-obstruction (point)



Symbol Graphic

Symbol Placement Instructions: Origin: Center of open circle

Symbol Type: Simple

Component Ref #:	P00148	Component Type:	Point - Shape	Color Token:	Black
Description:	Water intake tower				
<a href="#">Parameters:</a>					
Note:	See Annex H for detailed drawing instructions.				

### Symbol Rules

Reference #:	Description:	Criteria:
PS-04226	Water Intake Tower / non-obstruction (point)	Height Above Surface Level [HGT] < 46

### Symbol Samples



## Water Treatment Bed (BH040)

Generalization Rules (see Annex J): GA-9999

### Water Treatment Bed / all (area)



Symbol Graphic

Symbol Placement Instructions: The symbol is applied to the geometry of the feature.

Symbol Type: Complex

Note: Component L00007 is applied to the perimeter and is filled with Component A00007.

Component Ref #:	A00007	Component Type:	Area - Fill	Color Token:	Cyan-31
Description:	Cyan-31 area fill				
<u>Parameters:</u>					
Screen Angle:	45 degrees				
Screen Percent:	31%				

Component Ref #:	L00007	Component Type:	Line - Simple	Color Token:	Black
Description:	Black 0.1mm Solid Line				
<u>Parameters:</u>					
Line Weight:	0.1mm				

Symbol Rules

Reference #:	Description:	Criteria:
PS-04183	Water Treatment Bed / all (area)	All

Symbol Samples



## Waterfall (BH180)

Generalization Rules (see Annex J): GA-9999

### Waterfall / all (line)



Symbol Graphic

Symbol Placement Instructions: The symbol is applied to the geometry of the feature.

Symbol Type: Simple

Component Ref #:	L00015	Component Type:	Line - Simple	Color Token:	Cyan
Description:	Cyan 0.2mm Solid Line				
<u>Parameters:</u>					
Line Weight:	0.2mm				

Symbol Rules

Reference #:	Description:	Criteria:
PS-04212	Waterfall / all (line)	All

Label Rules

Label Placement Rules (see Annex J): LP-3505, LP-4813, LP-9999

Reference #:	Description:	Criteria:
PL-04212_1	Waterfall / all (line)	N/A

Label String: [Name] "Falls"  
 Characteristics: 16, 16  
 16 (Cyan, Condensed, Italic, 6 pt, Mixed case)

Symbol Samples

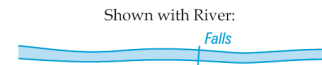

## Waterfall / all (point)

Symbol Graphic

Symbol Placement Instructions: Origin: Center of symbol

Symbol Type: Simple

Note: The symbol is orientated perpendicular to the associated drainage feature.

Component Ref #:	P00061	Component Type:	Point - Simple	Color Token:	Cyan
Description:	Cyan 1.5mm length line with a 0.2mm lineweight				
Parameters:					
Line Weight:	0.2mm				
Length:	1.5mm				

### Symbol Rules

Reference #:	Description:	Criteria:
PS-04213	Waterfall / all (point)	All

### Label Rules

Label Placement Rules (see Annex J): LP-3505, LP-4813, LP-9999

Reference #:	Description:	Criteria:
PL-04213_1	Waterfall / all (point)	N/A

Label String: [Name] "Falls"  
 Characteristics: 16, 16  
 16 (Cyan, Condensed, Italic, 6 pt, Mixed case)

### Symbol Samples



## Well (AA050)

### Well / non-water / all (point)

Symbol Graphic

Symbol Placement Instructions: Origin: Center of symbol

Symbol Type: Simple

Note: The component is an open circle.

Component Ref #:	P00009	Component Type:	Point - Simple	Color Token:	Black
Description:	Non-water well				
Parameters:					
Diameter:	1.0mm				
Line Weight:	0.15mm				
Note:	The component is an open circle.				

## Symbol Rules

Reference #:	Description:	Criteria:
PS-04273	Well / non-water / all (point)	Product [PPO] = (Gas [45], Multiple [996], Oil [75], Unknown [0])

## Label Rules

Label Placement Rules (see Annex J): LP-3505, LP-9950, LP-9999

Reference #:	Description:	Criteria:
PL-04273_1	Well / non-water / intact / gas (point)	Condition of Facility [FUN] = (Fully Functional [6], Unknown [0]) AND Product [PPO] = Gas [45]
	Label String: "Gas" Characteristics: 1 1 (Black, Condensed, 6 pt, Mixed case)	
PL-04273_2	Well / non-water / intact / oil (point)	Condition of Facility [FUN] = (Fully Functional [6], Unknown [0]) AND Product [PPO] = Oil [75]
	Label String: "Oil" Characteristics: 1 1 (Black, Condensed, 6 pt, Mixed case)	
PL-04273_3	Well / non-water / not intact / gas (point)	Condition of Facility [FUN] = (Abandoned [2], Damaged [13], Destroyed [3], Dismantled [4], Under Construction [1]) AND Product [PPO] = Gas [45]
	Label String: "Gas" "["[Condition of Facility]" Characteristics: 1, 22, 22, 22 1 (Black, Condensed, 6 pt, Mixed case) 22 (Black, Condensed, 6 pt, Lower case)	
PL-04273_4	Well / non-water / not intact / oil (point)	Condition of Facility [FUN] = (Abandoned [2], Damaged [13], Destroyed [3], Dismantled [4], Under Construction [1]) AND Product [PPO] = Oil [75]
	Label String: "Oil" "["[Condition of Facility]" Characteristics: 1, 22, 22, 22 1 (Black, Condensed, 6 pt, Mixed case) 22 (Black, Condensed, 6 pt, Lower case)	
PL-04273_5	Well / non-water / not intact / other (point)	Condition of Facility [FUN] = (Abandoned [2], Damaged [13], Destroyed [3], Dismantled [4], Under Construction [1]) AND Product [PPO] = (Multiple [996], Unknown [0])
	Label String: "["[Condition of Facility]" Characteristics: 22, 22, 22 22 (Black, Condensed, 6 pt, Lower case)	

## Symbol Samples

o

o Oil

o Gas (damaged)

## Well / water / perennial (point)





Symbol Placement Instructions: Origin: Center of symbol

Symbol Type: Simple

Symbol Graphic

Component Ref #: P00041      Component Type: Point - Simple      Color Token: Cyan

Description: Cyan 0.8mm diameter filled circle

Parameters:

Diameter: 0.8mm

Note: The component is a circle and is filled with the solid color.

**Symbol Rules**

Reference #:	Description:	Criteria:	
<b>PS-04050</b>	<b>Well / water / perennial (point)</b>	Product [PPO] = Water [122]	
		AND Hydrologic Persistence [HYP] = Perennial [1]	

**Label Rules**

Label Placement Rules (see Annex J): LP-3505, LP-9950, LP-9999

Reference #:	Description:	Criteria:	
<b>PL-04050_1</b>	<b>Well / water / perennial / intact / other (point)</b>	Condition of Facility [FUN] = (Fully Functional [6], Unknown [0])	
		AND Water Type [SCC] = Not Applicable [998], Other [999], Potable [9], Unknown [0]	
	Label String: [Name]		
	Characteristics: 16 16 (Cyan, Condensed, Italic, 6 pt, Mixed case)		
<b>PL-04050_2</b>	<b>Well / water / perennial / intact / alkaline (point)</b>	Condition of Facility [FUN] = (Fully Functional [6], Unknown [0])	
		AND Water Type [SCC] = Alkaline [1]	
	Label String: [Name] "(alkaline)"		
	Characteristics: 16, 23 16 (Cyan, Condensed, Italic, 6 pt, Mixed case) 23 (Cyan, Condensed, Italic, 6 pt, Lower case)		
<b>PL-04050_3</b>	<b>Well / water / perennial / intact / salt (point)</b>	Condition of Facility [FUN] = (Fully Functional [6], Unknown [0])	
		AND Water Type [SCC] = (Mineral [4], Salty [10])	
	Label String: [Name] "(salt)"		
	Characteristics: 16, 23 16 (Cyan, Condensed, Italic, 6 pt, Mixed case) 23 (Cyan, Condensed, Italic, 6 pt, Lower case)		
<b>PL-04050_4</b>	<b>Well / water / perennial / not intact / other (point)</b>	Condition of Facility [FUN] = (Abandoned [2], Damaged [13], Destroyed [3], Dismantled [4], Under Construction [1])	
		AND Water Type [SCC] = Not Applicable [998], Other [999], Potable [9], Unknown [0]	
	Label String: [Name] "["[Condition of Facility]"		
	Characteristics: 16, 23, 23, 23 16 (Cyan, Condensed, Italic, 6 pt, Mixed case) 23 (Cyan, Condensed, Italic, 6 pt, Lower case)		
<b>PL-04050_5</b>	<b>Well / water / perennial / not intact / alkaline (point)</b>	Condition of Facility [FUN] = (Abandoned [2], Damaged [13], Destroyed [3], Dismantled [4], Under Construction [1])	

AND Water Type [SCC] = Alkaline [1]

Label String: [Name] "(alkaline)" "("[Condition of Facility]"")"

Characteristics: 16, 23, 23, 23, 23  
 16 (Cyan, Condensed, Italic, 6 pt, Mixed case)  
 23 (Cyan, Condensed, Italic, 6 pt, Lower case)

**PL-04050\_6 Well / water / perennial / not intact / salt (point)**

Condition of Facility [FUN] = (Abandoned [2], Damaged [13], Destroyed [3], Dismantled [4], Under Construction [1])

AND Water Type [SCC] = (Mineral [4], Salty [10])

Label String: [Name] "(salt)" "("[Condition of Facility]"")"

Characteristics: 16, 23, 23, 23, 23  
 16 (Cyan, Condensed, Italic, 6 pt, Mixed case)  
 23 (Cyan, Condensed, Italic, 6 pt, Lower case)

Symbol Samples

• Greensburg Well

• (alkaline)

Well / water / intermittent, dry (point)



Symbol Graphic

Symbol Placement Instructions: Origin: Center of symbol

Symbol Type: Simple

Component Ref #:	P00040	Component Type:	Point - Simple	Color Token:	Cyan
Description:	Qanat/Water well intermittent				
<u>Parameters:</u>					
Diameter:	1.0mm				
Line Weight:	0.15mm				
Note:	The component is an open circle.				

Symbol Rules

Reference #:	Description:	Criteria:
PS-04051	Well / water / intermittent, dry (point)	Product [PPO] = Water [122]
		AND Hydrologic Persistence [HYP] = (Dry [4], Intermittent [2], Unknown [0])

Label Rules

Label Placement Rules (see Annex J): LP-3505, LP-9950, LP-9999

Reference #:	Description:	Criteria:
PL-04051_1	Well / water / intermittent, dry / intact / other (point)	Condition of Facility [FUN] = (Fully Functional [6], Unknown [0])
		AND Water Type [SCC] = (Not Applicable [998], Other [999], Potable [9], Unknown [0])

Label String: [Name]

Characteristics: 16  
 16 (Cyan, Condensed, Italic, 6 pt, Mixed case)

**PL-04051\_2 Well / water / intermittent, dry / intact / alkaline (point)**

Condition of Facility [FUN] = (Fully Functional [6], Unknown [0])

AND Water Type [SCC] = Alkaline [1]

Label String: [Name] "(alkaline)"  
 Characteristics: 16, 23  
 16 (Cyan, Condensed, Italic, 6 pt, Mixed case)  
 23 (Cyan, Condensed, Italic, 6 pt, Lower case)

**PL-04051\_3 Well / water / intermittent, dry / intact / salt (point)** Condition of Facility [FUN] = (Fully Functional [6], Unknown [0])

AND Water Type [SCC] = (Mineral [4], Salty [10])

Label String: [Name] "(salt)"  
 Characteristics: 16, 23  
 16 (Cyan, Condensed, Italic, 6 pt, Mixed case)  
 23 (Cyan, Condensed, Italic, 6 pt, Lower case)

**PL-04051\_4 Well / water / intermittent, dry / not intact / other (point)** Condition of Facility [FUN] = (Abandoned [2], Damaged [13], Destroyed [3], Dismantled [4], Under Construction [1])

AND Water Type [SCC] = Not Applicable [998], Other [999], Potable [9], Unknown [0]

Label String: [Name] "["[Condition of Facility]""]  
 Characteristics: 16, 23, 23, 23  
 16 (Cyan, Condensed, Italic, 6 pt, Mixed case)  
 23 (Cyan, Condensed, Italic, 6 pt, Lower case)

**PL-04051\_5 Well / water / intermittent, dry / not intact / alkaline (point)** Condition of Facility [FUN] = (Abandoned [2], Damaged [13], Destroyed [3], Dismantled [4], Under Construction [1])

AND Water Type [SCC] = Alkaline [1]

Label String: [Name] "(alkaline)" "["[Condition of Facility]""]  
 Characteristics: 16, 23, 23, 23, 23  
 16 (Cyan, Condensed, Italic, 6 pt, Mixed case)  
 23 (Cyan, Condensed, Italic, 6 pt, Lower case)

**PL-04051\_6 Well / water / intermittent, dry / not intact / salt (point)** Condition of Facility [FUN] = (Abandoned [2], Damaged [13], Destroyed [3], Dismantled [4], Under Construction [1])

AND Water Type [SCC] = (Mineral [4], Salty [10])

Label String: [Name] "(salt)" "["[Condition of Facility]""]  
 Characteristics: 16, 23, 23, 23, 23  
 16 (Cyan, Condensed, Italic, 6 pt, Mixed case)  
 23 (Cyan, Condensed, Italic, 6 pt, Lower case)

Symbol Samples



Woodingdean Well

Famous Well (salt) (destroyed)

Wind Turbine (AJ051)

Wind Turbine / non-obstruction (point)



Symbol Graphic

Symbol Placement Instructions: Origin: Center of open circle

Symbol Type: Simple

Component Ref #: P00143 Component Type: Point - Shape Color Token: Black  
 Description: Wind turbine  
 Parameters:

Note: See Annex H for detailed drawing instructions.

Symbol Rules

Reference #:	Description:	Criteria:
PS-04054	Wind Turbine / non-obstruction (point)	Height Above Surface Level [HGT] < 46

Symbol Samples



Windmill (AJ050)

Windmill / non-obstruction (point)



Symbol Graphic

Symbol Placement Instructions: Origin: Center of open circle  
 Symbol Type: Simple

Component Ref #:	P00144	Component Type:	Point - Shape	Color Token:	Black
Description:	Windmill				
<a href="#">Parameters:</a>					
Note:	See Annex H for detailed drawing instructions.				

Symbol Rules

Reference #:	Description:	Criteria:
PS-04049	Windmill / non-obstruction (point)	Height Above Surface Level [HGT] < 46

Symbol Samples



Wood (EC030)

Generalization Rules (see Annex J): GA-9999

Wood / unknown (area)



Symbol Graphic

Symbol Placement Instructions: The symbol is applied to the geometry of the feature.  
 Symbol Type: Simple

Component Ref #:	A00009	Component Type:	Area - Fill	Color Token:	Green362-31
Description:	Green362-31 area Fill				
<a href="#">Parameters:</a>					
Screen Angle:	45 degrees				
Screen Percent:	31%				

Symbol Rules

Reference #:	Description:	Criteria:
<b>PS-04795</b>	<b>Wood / unknown (area)</b>	Canopy Cover [DMT] >= 51
		AND Foliage Type [TRE] = (Unknown[0])

Label Rules

Label Placement Rules (see Annex J): LP-0050, LP-3506, LP-9999

Reference #:	Description:	Criteria:
<b>PL-04795_1</b>	<b>Wood / unknown (area)</b>	N/A

Label String: [Name]  
 Characteristics: 3  
 3 (Black, Condensed, 6-16 pt, Mixed case)

Symbol Samples



Wood / evergreen (area)



Symbol Graphic

Symbol Placement Instructions: The symbol is applied to the geometry of the feature.

Symbol Type: Compound

Note: Components A00009 and A00012 are combined into one symbol. Display level from bottom to top: Component A00009; Component A00012.

Component Ref #:	A00009	Component Type:	Area - Fill	Color Token:	Green362-31
Description:	Green362-31 area Fill				
Parameters:					
Screen Angle:	45 degrees				
Screen Percent:	31%				

Component Ref #:	A00012	Component Type:	Area - Pattern	Color Token:	Green362
Description:	Green362 Evergreen Tree Fill				
Parameters:					
Area Pattern:	AP-60, see Annex I				

Symbol Rules

Reference #:	Description:	Criteria:
<b>PS-04796</b>	<b>Wood / evergreen (area)</b>	Canopy Cover [DMT] >= 51
		AND Foliage Type [TRE] = Evergreen [2]

Label Rules

Label Placement Rules (see Annex J): LP-0050, LP-3506, LP-9999

Reference #:	Description:	Criteria:
<b>PL-04796_1</b>	<b>Wood / evergreen (area)</b>	N/A

Label String: [Name]  
 Characteristics: 3  
 3 (Black, Condensed, 6-16 pt, Mixed case)

Symbol Samples



## Wood / deciduous (area)



Symbol Graphic

**Symbol Placement Instructions:** The symbol is applied to the geometry of the feature.

**Symbol Type:** Compound

**Note:** Components A00009 and A00011 are combined into one symbol. Display level from bottom to top: Component A00009; Component A00011.

<b>Component Ref #:</b>	A00009	<b>Component Type:</b>	Area - Fill	<b>Color Token:</b>	Green362-31
<b>Description:</b>	Green362-31 area Fill				
<b>Parameters:</b>					
<b>Screen Angle:</b>	45 degrees				
<b>Screen Percent:</b>	31%				

<b>Component Ref #:</b>	A00011	<b>Component Type:</b>	Area - Pattern	<b>Color Token:</b>	Green362
<b>Description:</b>	Green362 Deciduous Tree Fill				
<b>Parameters:</b>					
<b>Area Pattern:</b>	AP-54, see Annex I				

### Symbol Rules

<b>Reference #:</b>	<b>Description:</b>	<b>Criteria:</b>
PS-04797	Wood / deciduous (area)	Canopy Cover [DMT] >= 51
		AND Foliage Type [TRE] = Deciduous [1]

### Label Rules

Label Placement Rules (see Annex J): LP-0050, LP-3506, LP-9999

<b>Reference #:</b>	<b>Description:</b>	<b>Criteria:</b>
PL-04797_1	Wood / deciduous (area)	N/A

**Label String:** [Name]  
**Characteristics:** 3  
 3 (Black, Condensed, 6-16 pt, Mixed case)

### Symbol Samples



## Wood / mixed (area)



Symbol Graphic

**Symbol Placement Instructions:** The symbol is applied to the geometry of the feature.

**Symbol Type:** Compound

**Note:** Components A00009 and A00013 are combined into one symbol. Display level from bottom to top: Component A00009; Component A00013.

<b>Component Ref #:</b>	A00009	<b>Component Type:</b>	Area - Fill	<b>Color Token:</b>	Green362-31
<b>Description:</b>	Green362-31 area Fill				
<b>Parameters:</b>					
<b>Screen Angle:</b>	45 degrees				

Screen Percent: 31%

Component Ref #: A00013      Component Type: Area - Pattern      Color Token: Green362  
 Description: Green362 Mixed Tree Fill  
Parameters:  
 Area Pattern: AP-63, see Annex I

**Symbol Rules**

Reference #: **PS-04798**      Description: **Wood / mixed (area)**      Criteria:  
 Canopy Cover [DMT] >= 51  
 AND      Foliage Type [TRE] = Mixed [3]

**Label Rules**

Label Placement Rules (see Annex J): LP-0050, LP-3506, LP-9999

Reference #: **PL-04798\_1**      Description: **Wood / mixed (area)**      Criteria:  
 N/A

Label String: [Name]  
 Characteristics: 3  
 3 (Black, Condensed, 6-16 pt, Mixed case)

**Symbol Samples**



**Wood / scattered (area)**

Symbol Placement Instructions: The symbol is applied to the geometry of the feature.  
 Symbol Type: Simple



Symbol Graphic

Component Ref #: A00047      Component Type: Area - Pattern      Color Token: Green362  
 Description: Green362 Scattered Trees Fill  
Parameters:  
 Area Pattern: AP-44, see Annex I

**Symbol Rules**

Reference #: **PS-04799**      Description: **Wood / scattered (area)**      Criteria:  
 Canopy Cover [DMT] < 51

**Label Rules**

Label Placement Rules (see Annex J): LP-0050, LP-3506, LP-9999

Reference #: **PL-04799\_1**      Description: **Wood / scattered (area)**      Criteria:  
 N/A

Label String: [Name]  
 Characteristics: 3  
 3 (Black, Condensed, 6-16 pt, Mixed case)

**Symbol Samples**



## Wood / all (line)



Symbol Graphic

Symbol Placement Instructions: The symbol is applied to the geometry of the feature.

Symbol Type: Simple

Note: Component P00111 is applied with a spacing of 0.5mm, center to center. The interval is such that the consecutive circles touch edges (centers of circles are 0.5mm apart).

Component Ref #:	P00111	Component Type:	Point - Simple	Color Token:	Green362
Description:	Forest/curve				
<u>Parameters:</u>					
Diameter:	0.5mm				
Line Weight:	0.1mm				
Note:	The component is an open circle.				

### Symbol Rules

Reference #:	Description:	Criteria:
PS-04800	Wood / all (line)	All

### Symbol Samples



## Wood / all (point)



Symbol Graphic

Symbol Placement Instructions: Origin: Center of symbol

Symbol Type: Simple

Component Ref #:	P00030	Component Type:	Point - Shape	Color Token:	Green362
Description:	Tree other				
<u>Parameters:</u>					
Note:	See Annex H for detailed drawing instructions.				

### Symbol Rules

Reference #:	Description:	Criteria:
PS-04808	Wood / all (point)	All

### Symbol Samples



## Wreck (BD180)

### Wreck / all (point)





Symbol Graphic

Symbol Placement Instructions: Origin: Center of open circle

Symbol Type: Simple

Component Ref #:	P00206	Component Type:	Point - Shape	Color Token:	Black
Description:	Wreck				
<a href="#">Parameters:</a>					
Note:	See Annex H for detailed drawing instructions.				

### Symbol Rules

Reference #:	Description:	Criteria:
PS-04659	Wreck / all (point)	All

### Symbol Samples



## Zoo (AK180)

Generalization Rules (see Annex J): GA-9999, GC-9999

### Zoo / all (area)



Symbol Graphic

Symbol Placement Instructions: The symbol is applied to the geometry of the feature.

Symbol Type: Simple

Component Ref #:	L00210	Component Type:	Line - Styled	Color Token:	Black
Description:	Black 0.1mm Dashed line (0.1mm wt, 1.0mm dash, 0.5mm gap)				
<a href="#">Parameters:</a>					
Line Weight:	0.1mm	Dash Length:	1.0mm	Dash Spacing:	0.5mm

### Symbol Rules

Reference #:	Description:	Criteria:
PS-04065	Zoo / all (area)	All

### Label Rules

Label Placement Rules (see Annex J): LP-3506, LP-4813, LP-9999

Reference #:	Description:	Criteria:
PL-04065_1	Zoo / all (area)	N/A

Label String: [Name] "Zoo"  
 Characteristics: 1, 1  
 1 (Black, Condensed, 6 pt, Mixed case)

### Symbol Samples



## Zoo / all (point)



Symbol Graphic

Symbol Placement Instructions: Origin: Center of symbol

Symbol Type: Simple

Component Ref #: P00006      Component Type: Point - Simple      Color Token: Black  
 Description: Black filled square with all sides 0.8mm  
[Parameters:](#)  
 Length: 0.8mm  
 Note: The component is a square and is filled with the solid color.

### Symbol Rules

Reference #:	Description:	Criteria:
PS-04511	Zoo / all (point)	All

### Label Rules

Label Placement Rules (see Annex J): LP-3505, LP-4813, LP-9999

Reference #:	Description:	Criteria:
PL-04511_1	Zoo / all (point)	N/A

Label String: [Name] "Zoo"  
 Characteristics: 1, 1  
 1 (Black, Condensed, 6 pt, Mixed case)

### Symbol Samples

■ Zoo

■ Nashville Zoo







## **Annex B – Feature Symbol Quick Reference Guide**

This annex provides an abbreviated listing of each feature symbol from Annex A. Symbol graphics in this Annex are examples only and may not show every instance of potential labeling. Representative labels are shown only for those symbols which always require labeling. Some symbols may require varying descriptive labels based on attribution (i.e. "Gas" or "Oil" for the Product [PPO] attribute on Well/non-water), and/or proper names when available. See Annex A for specific symbol and label rules.

Symbol	Number	Feature Code	Sample Graphic	Page
Administrative Boundary / international (line)	PS-04002	FA000		A - 1
Administrative Boundary / other separation (line)	PS-04001	FA000		A - 1
Administrative Boundary / no defined boundary (line)	PS-04450	FA000		A - 3
Administrative Division / first-order (area)	PS-04005	FA003		A - 3
Administrative Division / second-order (area)	PS-04006	FA003		A - 4
Administrative Division / other (area)	PS-04007	FA003		A - 5
Aeronautical Obstacle / single (point)	PS-04516	GB220		A - 6
Aeronautical Obstacle / multiple (point)	PS-04517	GB220		A - 6

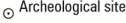
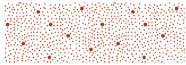
Symbol	Number	Feature Code	Sample Graphic	Page
Aeronautical Radio Navigation Service / all (point)	PS-04675	GA034	 Radio aid	A - 7
Aircraft Hangar / intact (area)	PS-04456	GB230	 Hangar	A - 8
Aircraft Hangar / not intact (area)	PS-04039	GB230		A - 9
Aircraft Hangar / intact (point)	PS-04455	GB230	 Hangar	A - 9
Aircraft Hangar / not intact (point)	PS-04040	GB230		A - 10
Aircraft Revetment / all (line)	PS-04008	GB050		A - 10
Aircraft Revetment / all (point)	PS-04037	GB050		A - 11
Amusement Park / all (area)	PS-04009	AK030	 Amusement park	A - 11
Amusement Park / intact (point)	PS-04459	AK030	 Amusement park	A - 12

Symbol	Number	Feature Code	Sample Graphic	Page
Amusement Park / not intact (point)	PS-04883	AK030	 Amusement park	A - 12
Approach Lighting System / all (point)	PS-04674	GB485	 Approach lighting system	A - 13
Apron / all (area)	PS-04010	GB015		A - 14
Aqueduct / intact (area)	PS-04461	BH010		A - 14
Aqueduct / not intact (area)	PS-04462	BH010		A - 15
Aqueduct / on ground (line)	PS-04011	BH010		A - 16
Aqueduct / elevated (line)	PS-04012	BH010		A - 16
Aqueduct / underground / without qanat shafts (line)	PS-04013	BH010		A - 17

Symbol	Number	Feature Code	Sample Graphic	Page
Aqueduct / underground / with qanat shafts (line)	PS-04463	BH010		A - 18
Aqueduct / all (point)	PS-04242	BH010		A - 19
Archeological Site / all (area)	PS-04017	AL012		A - 19
Archeological Site / all (point)	PS-04018	AL012		A - 20
Beach / pebble (area)	PS-04753	BA050		A - 20
Beach / sand (area)	PS-04754	BA050		A - 21
Beach / all (point)	PS-04755	BA050	<i>Red Beach</i>	A - 21
Berthing Structure / dry (area)	PS-04744	BB190		A - 22
Berthing Structure / not dry (area)	PS-04745	BB190		A - 23





Symbol	Number	Feature Code	Sample Graphic	Page
Berthing Structure / dry (line)	PS-04746	BB190		A - 23
Berthing Structure / not dry (line)	PS-04747	BB190		A - 24
Bog / all (area)	PS-04021	BH015		A - 24
Breakwater / dry (area)	PS-04756	BB041		A - 25
Breakwater / not dry (area)	PS-04757	BB041		A - 26
Breakwater / dry (line)	PS-04758	BB041		A - 26
Breakwater / not dry (line)	PS-04759	BB041		A - 27
Bridge / fixed / non-pedestrian (line)	PS-04130	AQ040		A - 27
Bridge / non-fixed / non-pedestrian (line)	PS-04131	AQ040		A - 28



Symbol	Number	Feature Code	Sample Graphic	Page
Bridge / pedestrian (line)	PS-04132	AQ040		A - 29
Bridge / fixed / non-pedestrian (point)	PS-04470	AQ040		A - 30
Bridge / non-fixed / non-pedestrian (point)	PS-04650	AQ040		A - 30
Bridge / pedestrian (point)	PS-04645	AQ040		A - 31
Built Up Area / intact / dense (area)	PS-04068	AL020		A - 32
Built Up Area / intact / sparse or moderate (area)	PS-04069	AL020		A - 33
Built Up Area / not intact (area)	PS-04070	AL020		A - 34
Built Up Area / all (point)	PS-04072	AL020	Monroe	A - 34
Cableway / non-obstruction (line)	PS-04155	AT041		A - 35

Symbol	Number	Feature Code	Sample Graphic	Page
Cableway / obstruction (line)	PS-04158	AT041		A - 36
Cairn / all (point)	PS-04073	AL025		A - 36
Camp / all (area)	PS-04481	AI030		A - 37
Camp / all (point)	PS-04480	AI030		A - 38
Camp Site / all (area)	PS-04022	AK060		A - 38
Camp Site / all (point)	PS-04482	AK060		A - 39
Canal / intact / perennial (area)	PS-04023	BH020		A - 39
Canal / intact / intermittent, dry (area)	PS-04024	BH020		A - 40
Canal / not intact (area)	PS-04025	BH020		A - 41

Symbol	Number	Feature Code	Sample Graphic	Page
Canal / intact / perennial (line)	PS-04026	BH020	 Canal	A - 42
Canal / not intact / intermittent, dry (line)	PS-04027	BH020	 Canal (construction)	A - 43
Cane / all (area)	PS-04028	EC010		A - 44
Cart Track / all (line)	PS-04128	AP010		A - 44
Catalytic Cracker / non-obstruction / intact (point)	PS-04029	AC020	 Catalytic cracker	A - 45
Catalytic Cracker / non-obstruction / not intact (point)	PS-04752	AC020		A - 46
Causeway Structure / all (line)	PS-04136	AQ063	 CAUSEWAY	A - 46
Cave Mouth / all (point)	PS-04032	DB029		A - 47

Symbol	Number	Feature Code	Sample Graphic	Page
Cemetery / other (area)	PS-04078	AL030		A - 47
Cemetery / buddhism (area)	PS-04075	AL030		A - 48
Cemetery / christian (area)	PS-04076	AL030		A - 49
Cemetery / islam (area)	PS-04074	AL030		A - 49
Cemetery / judaism (area)	PS-04077	AL030		A - 50
Cemetery / other (point)	PS-04083	AL030		A - 50
Cemetery / buddhism (point)	PS-04080	AL030		A - 51
Cemetery / christian (point)	PS-04079	AL030		A - 52
Cemetery / islam (point)	PS-04081	AL030		A - 52









Symbol	Number	Feature Code	Sample Graphic	Page
Cemetery / judaism (point)	PS-04082	AL030	†	A - 53
Checkpoint / all (point)	PS-04033	AH070	⊖	A - 53
Circular Irrigation System / all (area)	PS-04303	AJ010	Circular irrigation system	A - 54
Cistern / all (point)	PS-04052	BI010	▪	A - 54
Cleared Way / all (area)	PS-04853	EC040	{NO SYMBOL}	A - 55
Communication Line / non-obstruction (line)	PS-04729	AT060		A - 55
Communication Line / obstruction (line)	PS-04730	AT060		A - 56
Communication Station / non-obstruction (area)	PS-04726	AT050		A - 57

Symbol	Number	Feature Code	Sample Graphic	Page
Communication Station / non-obstruction / intact (point)	PS-04727	AT050	 Communication station	A - 57
Communication Station / non-obstruction / not intact (point)	PS-04728	AT050	 Communication station	A - 58
Conveyor / non-obstruction (line)	PS-04034	AF020	 Conveyor	A - 59
Conveyor / obstruction (line)	PS-04886	AF020	 Conveyor 243 (71)	A - 59
Conveyor / non-obstruction (point)	PS-04887	AF020	 Conveyor	A - 60
Conveyor / obstruction (point)	PS-04888	AF020	 Conveyor 245 (72)	A - 60
Crane / non-obstruction (point)	PS-04038	AF040		A - 61
Crevasse / all (area)	PS-04496	BJ031	 Crevasse	A - 61

Symbol	Number	Feature Code	Sample Graphic	Page
Crevasse / all (line)	PS-04497	BJ031		A - 62
Crevice / all (area)	PS-04498	DB061		A - 63
Crevice / all (line)	PS-04499	DB061		A - 63
Crop Land / dry crops (area)	PS-04304	EA010		A - 64
Crop Land / irrigated crops (area)	PS-04019	EA010		A - 65
Culvert / all (point)	PS-04705	AQ065	><	A - 65
Cut / all (line)	PS-04243	DB070		A - 66
Cut Line / all (line)	PS-04244	DB071		A - 66
Dam / hard (area)	PS-04214	BI020		A - 67

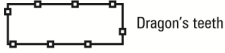
Symbol	Number	Feature Code	Sample Graphic	Page
Dam / loose (area)	PS-04215	BI020	 Dam	A - 68
Dam / hard / transportation (line)	PS-04217	BI020	 Dam	A - 68
Dam / loose / transportation (line)	PS-04502	BI020	 Dam	A - 69
Dam / hard / no transportation (line)	PS-04216	BI020		A - 70
Dam / loose / no transportation (line)	PS-04429	BI020		A - 70
Dam / hard (point)	PS-04218	BI020	-	A - 71
Dam / loose (point)	PS-04430	BI020	-	A - 71
Dish Aerial / non-obstruction (point)	PS-04152	AT010		A - 72
Disposal Site / non-obstruction (area)	PS-04278	AB000	 Disposal site	A - 72

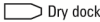

















Symbol	Number	Feature Code	Sample Graphic	Page
Ditch / perennial (area)	PS-04179	BH030		A - 73
Ditch / intermittent, dry (area)	PS-04180	BH030		A - 74
Ditch / perennial (line)	PS-04181	BH030		A - 74
Ditch / intermittent, dry (line)	PS-04182	BH030		A - 75
Dragon's Teeth / all (area)	PS-04503	AL060		A - 75
Dragon's Teeth / all (line)	PS-04504	AL060		A - 76
Dry Dock / all (area)	PS-04168	BB090		A - 77
Electric Power Station / all (area)	PS-04293	AD010		A - 77
Electric Power Station / intact (point)	PS-04294	AD010		A - 78

Symbol	Number	Feature Code	Sample Graphic	Page
Electric Power Station / not intact (point)	PS-04896	AD010		A - 79
Elevation Contour / land / index (line)	PS-04342	CA010		A - 79
Elevation Contour / land / index / approximate (line)	PS-04343	CA010		A - 80
Elevation Contour / land / intermediate (line)	PS-04346	CA010		A - 81
Elevation Contour / land / intermediate / approximate (line)	PS-04347	CA010		A - 82
Elevation Contour / land / half auxiliary (line)	PS-04350	CA010		A - 82
Elevation Contour / land / quarter auxiliary (line)	PS-04360	CA010		A - 83
Elevation Contour / land / mound / index (line)	PS-04358	CA010		A - 84



Symbol	Number	Feature Code	Sample Graphic	Page
Elevation Contour / land / mound / intermediate (line)	PS-04359	CA010		A - 85
Elevation Contour / land / depression / index (line)	PS-04354	CA010		A - 86
Elevation Contour / land / depression / intermediate (line)	PS-04356	CA010		A - 87
Elevation Contour / land / depression / auxiliary (line)	PS-04362	CA010		A - 87
Elevation Contour / snow, ice / index (line)	PS-04344	CA010		A - 88
Elevation Contour / snow, ice / index / approximate (line)	PS-04345	CA010		A - 89
Elevation Contour / snow, ice / intermediate (line)	PS-04348	CA010		A - 90
Elevation Contour / snow, ice / intermediate / approximate (line)	PS-04349	CA010		A - 91

Symbol	Number	Feature Code	Sample Graphic	Page
Elevation Contour / snow, ice / half auxiliary (line)	PS-04351	CA010		A - 91
Elevation Contour / snow, ice / quarter auxiliary (line)	PS-04361	CA010		A - 92
Elevation Contour / snow, ice / mound / index (line)	PS-04738	CA010		A - 93
Elevation Contour / snow, ice / mound / intermediate (line)	PS-04739	CA010		A - 94
Elevation Contour / snow, ice / depression / index (line)	PS-04355	CA010		A - 95
Elevation Contour / snow, ice / depression / intermediate (line)	PS-04357	CA010		A - 96
Elevation Contour / snow, ice / depression / auxiliary (line)	PS-04363	CA010		A - 97
Embankment / all (area)	PS-04246	DB090		A - 98







Symbol	Number	Feature Code	Sample Graphic	Page
Embankment / fill (line)	PS-04248	DB090		A - 98
Embankment / with transportation (line)	PS-04250	DB090		A - 99
Embankment / without transportation (line)	PS-04251	DB090		A - 99
Engineered Earthwork / all (line)	PS-04508	AH025		A - 100
Entrance and/or Exit / all (point)	PS-04725	AQ090		A - 101
Esker / all (line)	PS-04509	DB100		A - 101
Extraction Mine / intact / not peat (area)	PS-04266	AA010		A - 102
Extraction Mine / not intact / not peat (area)	PS-04267	AA010		A - 104
Extraction Mine / peat (area)	PS-04268	AA010		A - 105







Symbol	Number	Feature Code	Sample Graphic	Page
Extraction Mine / intact / not peat (point)	PS-04269	AA010		A - 106
Extraction Mine / not intact / not peat (point)	PS-04270	AA010		A - 108
Extraction Mine / peat (point)	PS-04271	AA010	 Peat cuttings	A - 110
Facility / all (area)	PS-04280	AL010	 Military	A - 110
Facility / intact (point)	PS-04286	AL010	 Government	A - 112
Facility / not intact (point)	PS-04291	AL010	 Transport	A - 113
Fairground / all (area)	PS-04057	AK090	 Fairgrounds	A - 114
Fairground / all (point)	PS-04510	AK090	 Fairgrounds	A - 114
Fence / all (line)	PS-04084	AL070		A - 115

Symbol	Number	Feature Code	Sample Graphic	Page
Ferry Crossing / all (line)	PS-04137	AQ070		A - 115
Ferry Crossing / all (point)	PS-04531	AQ070		A - 116
Firing Range / all (area)	PS-04532	FA015		A - 116
Firing Range / all (point)	PS-04838	FA015		A - 117
Fish Farm Facility / all (area)	PS-04184	BH051		A - 118
Fish Farm Facility / intact (point)	PS-04530	BH051		A - 118
Fish Farm Facility / not intact (point)	PS-04673	BH051		A - 119
Flare Pipe / non-obstruction (point)	PS-04041	AF070		A - 120
Flume / on surface (line)	PS-04773	BH060		A - 120

Symbol	Number	Feature Code	Sample Graphic	Page
Flume / below surface (line)	PS-04774	BH060		A - 121
Ford / all (point)	PS-04186	BH070		A - 121
Forest Clearing / all (area)	PS-04852	EC060	{NO SYMBOL}	A - 122
Fortification / all (area)	PS-04046	AH050		A - 122
Fortification / all (point)	PS-04047	AH050		A - 123
General Building / non-obstruction / intact / generic or important (area)	PS-04680	AL015		A - 124
General Building / non-obstruction / intact / christian (area)	PS-04681	AL015		A - 125
General Building / non-obstruction / intact / islam (area)	PS-04682	AL015		A - 125



Symbol	Number	Feature Code	Sample Graphic	Page
General Building / non-obstruction / intact / pagoda (area)	PS-04683	AL015		A - 126
General Building / non-obstruction / intact / stupa (area)	PS-04684	AL015		A - 127
General Building / non-obstruction / intact / judaism (area)	PS-04685	AL015		A - 127
General Building / non-obstruction / intact / temple (area)	PS-04686	AL015		A - 128
General Building / non-obstruction / intact / house of worship (area)	PS-04687	AL015	 House of worship	A - 129
General Building / non-obstruction / intact / school (area)	PS-04688	AL015		A - 130
General Building / non-obstruction / intact / hospital (area)	PS-04689	AL015		A - 130

Symbol	Number	Feature Code	Sample Graphic	Page
General Building / non-obstruction / intact / diplomatic (area)	PS-04691	AL015		A - 131
General Building / non-obstruction / intact / petrol sale (area)	PS-04708	AL015		A - 132
General Building / non-obstruction / not intact (area)	PS-04692	AL015		A - 132
General Building / non-obstruction / intact / generic (point)	PS-04693	AL015		A - 133
General Building / non-obstruction / intact / important (point)	PS-04694	AL015		A - 134
General Building / non-obstruction / intact / christian (point)	PS-04695	AL015		A - 135
General Building / non-obstruction / intact / minaret (point)	PS-04696	AL015		A - 135

Symbol	Number	Feature Code	Sample Graphic	Page
General Building / non-obstruction / intact / islam (point)	PS-04697	AL015	☩	A - 136
General Building / non-obstruction / intact / pagoda (point)	PS-04698	AL015	🗼	A - 137
General Building / non-obstruction / intact / stupa (point)	PS-04699	AL015	⚔	A - 137
General Building / non-obstruction / intact / judaism (point)	PS-04700	AL015	Ⓢ	A - 138
General Building / non-obstruction / intact / temple (point)	PS-04701	AL015	☎	A - 139
General Building / non-obstruction / intact / house of worship (point)	PS-04704	AL015	■ House of worship	A - 139
General Building / non-obstruction / intact / school (point)	PS-04706	AL015	🎓	A - 140

Symbol	Number	Feature Code	Sample Graphic	Page
General Building / non-obstruction / intact / hospital (point)	PS-04707	AL015		A - 141
General Building / non-obstruction / intact / diplomatic (point)	PS-04476	AL015		A - 141
General Building / non-obstruction / intact / petrol sale (point)	PS-04709	AL015		A - 142
General Building / non-obstruction / not intact (point)	PS-04714	AL015		A - 143
Geologic Fault / all (line)	PS-04252	DB110		A - 143
Geophysical Prospecting Grid / all (line)	PS-04899	FA090		A - 144
Geopolitical Entity / other (area)	PS-04537	FA002		A - 144
Geopolitical Entity / buffer zone (area)	PS-04876	FA002		A - 145

Symbol	Number	Feature Code	Sample Graphic	Page
Geothermal Outlet / all (area)	PS-04253	DB115	 Geothermal outlet	A - 146
Geothermal Outlet / all (point)	PS-04254	DB115	 Geothermal outlet	A - 146
Glacier / all (area)	PS-04228	BJ030		A - 147
Golf Course / all (area)	PS-04058	AK100	 Golf course	A - 148
Grain Elevator / non-obstruction / intact (area)	PS-04106	AM030	 Grain elevator	A - 148
Grain Elevator / non-obstruction / not intact (area)	PS-04781	AM030	 Grain elevator	A - 149
Grain Elevator / non-obstruction (point)	PS-04105	AM030	 Grain elevator	A - 150
Grain Storage Structure / non-obstruction / intact (area)	PS-04101	AM020	 Silo	A - 150



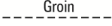





Symbol	Number	Feature Code	Sample Graphic	Page
Grain Storage Structure / non-obstruction / not intact (area)	PS-04784	AM020	 Silo	A - 151
Grain Storage Structure / non-obstruction (point)	PS-04102	AM020	 Silo	A - 152
Grassland / all (area)	PS-04030	EB010		A - 152
Greenhouse / all (area)	PS-04396	AJ110		A - 153
Greenhouse / all (point)	PS-04397	AJ110		A - 153
Groin / dry (area)	PS-04760	BB043	 Groin	A - 154
Groin / not dry (area)	PS-04761	BB043	 Groin	A - 154
Groin / dry (line)	PS-04762	BB043	 Groin	A - 155

Symbol	Number	Feature Code	Sample Graphic	Page
Groin / not dry (line)	PS-04763	BB043		A - 156
Gully / all (area)	PS-04566	DB200		A - 156
Gully / all (line)	PS-04567	DB200		A - 157
Harbour / all (area)	PS-04602	BB005		A - 157
Hazardous Rock / exposed (point)	PS-04658	BD130		A - 158
Heating Facility / all (area)	PS-04299	AD050		A - 158
Heating Facility / intact (point)	PS-04300	AD050		A - 159
Heating Facility / not intact (point)	PS-04907	AD050		A - 159
Hedgerow / all (line)	PS-04307	EA020		A - 160

Symbol	Number	Feature Code	Sample Graphic	Page
Helipad / non-hospital (point)	PS-04326	GB030		A - 161
Helipad / hospital (point)	PS-04327	GB030		A - 161
Helipoint / all (area)	PS-04328	GB035		A - 162
Holding Pen / all (area)	PS-04048	AJ030		A - 163
Holding Pen / all (point)	PS-04542	AJ030		A - 163
Hop Field / all (area)	PS-04316	EA055		A - 164
Hut / all (point)	PS-04545	AL099		A - 164
Hydrocarbons Field / all (area)	PS-04548	AA052		A - 165
Ice Cliff / all (line)	PS-04229	BJ040		A - 165

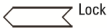













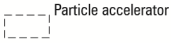

Symbol	Number	Feature Code	Sample Graphic	Page
Ice Peak / all (point)	PS-04230	BJ060		A - 166
Ice Route / all (line)	PS-04138	AQ075		A - 166
Island / all (area)	PS-04164	BA030		A - 167
Lake / perennial (area)	PS-04764	BH080		A - 168
Lake / intermittent, dry (area)	PS-04765	BH080		A - 168
Land Aerodrome / all (area)	PS-04317	GB005		A - 169
Land Subject To Inundation / not controlled (area)	PS-04192	BH090		A - 170
Land Subject To Inundation / controlled (area)	PS-04193	BH090		A - 171
Land Water Boundary / other (line)	PS-04162	BA010		A - 171

Symbol	Number	Feature Code	Sample Graphic	Page
Land Water Boundary / mangrove, marsh (line)	PS-04163	BA010		A - 172
Launch Pad / all (point)	PS-04315	GB040	 Launch pad	A - 172
Leader Line / black (curve)	PS-04948	No Code		A - 173
Leader Line / cyan (curve)	PS-04949	No Code		A - 173
Leader Line / aero blue (curve)	PS-04950	No Code		A - 174
Lock / all (area)	PS-04221	BI030		A - 174
Lock / all (line)	PS-04222	BI030		A - 175
Lock / all (point)	PS-04223	BI030		A - 175
Mangrove Swamp (area)	PS-04302	ED030		A - 176



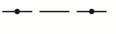





Symbol	Number	Feature Code	Sample Graphic	Page
Mariculture Site / all (area)	PS-04767	BH050	 Mariculture site	A - 177
Mariculture Site / intact (point)	PS-04779	BH050	 Mariculture site	A - 177
Mariculture Site / not intact (point)	PS-04780	BH050	 Mariculture site	A - 178
Maritime Signal Station / intact (point)	PS-04599	BB155	 Signal station	A - 178
Maritime Signal Station / not intact (point)	PS-04103	BB155	 Signal station	A - 179
Marsh / all (area)	PS-04312	ED010		A - 180
Memorial Monument / non-obstruction (point)	PS-04087	AL130		A - 181
Military Installation / all (area)	PS-04324	SU001	 MILITARY INSTALLATION	A - 181
Military Installation / intact (point)	PS-04325	SU001	 Military installation	A - 182

Symbol	Number	Feature Code	Sample Graphic	Page
Military Installation / not intact (point)	PS-04913	SU001	 Military installation	A - 183
Mineral Pile / non-obstruction (area)	PS-04109	AM040	 Mineral pile	A - 183
Mineral Pile / non-obstruction (point)	PS-04110	AM040	 Mineral pile	A - 184
Mooring Mast / non-obstruction (point)	PS-04139	AQ110		A - 185
Moraine / all (area)	PS-04227	BJ020		A - 185
Mountain Pass / all (point)	PS-04255	DB150		A - 186
Named Location / all (point)	PS-04323	ZD040	BADLANDS	A - 186
Natural Pool / perennial (point)	PS-04210	BH170		A - 187
Natural Pool / intermittent, dry (point)	PS-04211	BH170		A - 187









Symbol	Number	Feature Code	Sample Graphic	Page
Oasis / all (area)	PS-04310	EC020		A - 188
Oasis / all (point)	PS-04654	EC020		A - 189
Offshore Platform / non-obstruction (point)	PS-04201	BD110		A - 189
Orchard / all (area)	PS-04305	EA040		A - 190
Park / all (area)	PS-04059	AK120		A - 190
Park / all (point)	PS-04594	AK120		A - 191
Particle Accelerator / all (area)	PS-04090	AL140		A - 192
Particle Accelerator / all (line)	PS-04597	AL140		A - 192
Penstock / on surface (line)	PS-04194	BH110		A - 193

Symbol	Number	Feature Code	Sample Graphic	Page
Penstock / below surface (line)	PS-04195	BH110		A - 193
Penstock / above surface (line)	PS-04196	BH110		A - 194
Pipeline / on surface / not water (line)	PS-04329	AQ113		A - 195
Pipeline / on surface / water (line)	PS-04330	AQ113		A - 195
Pipeline / below surface / not water (line)	PS-04331	AQ113		A - 196
Pipeline / below surface / water (line)	PS-04332	AQ113		A - 197
Pipeline / above surface / not water (line)	PS-04333	AQ113		A - 198
Pipeline / above surface / water (line)	PS-04334	AQ113		A - 198
Point of Change / all (point)	PS-04857	No Code		A - 199

Symbol	Number	Feature Code	Sample Graphic	Page
Power Line / non-obstruction (line)	PS-04433	AT030		A - 200
Power Line / obstruction (line)	PS-04474	AT030		A - 200
Power Substation / all (area)	PS-04297	AD030		A - 201
Power Substation / all (point)	PS-04298	AD030		A - 202
Processing Facility / all (area)	PS-04410	AC000		A - 202
Processing Facility / intact (point)	PS-04411	AC000		A - 203
Processing Facility / not intact (point)	PS-04412	AC000		A - 204
Protection Shed / all (line)	PS-04558	AL210		A - 205
Protection Shed / all (point)	PS-04563	AL210		A - 206

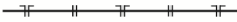
Symbol	Number	Feature Code	Sample Graphic	Page
Public Square / all (area)	PS-04091	AL170	 Union Square	A - 206
Pumping Station / all (area)	PS-04142	AQ116	 Pumping station	A - 207
Pumping Station / intact (point)	PS-04143	AQ116	 Pumping station	A - 207
Pumping Station / not intact (point)	PS-04917	AQ116	 Pumping station	A - 208
Pylon / non-obstruction (point)	PS-04866	AT042	 Pylon	A - 209
Pylon / obstruction (point)	PS-04947	AT042	 Pylon 213 (49)	A - 209
Quarry / intact (area)	PS-04669	AA012	 Quarry	A - 210
Quarry / not intact (area)	PS-04670	AA012	 Quarry	A - 211
Quarry / intact (point)	PS-04671	AA012	 Quarry	A - 212



Symbol	Number	Feature Code	Sample Graphic	Page
Quarry / not intact (point)	PS-04672	AA012	 Quarry	A - 213
Racetrack / all (line)	PS-04060	AK130	 Racetrack	A - 214
Radar Station / intact (point)	PS-04159	AT045	 Radar station	A - 215
Radar Station / not intact (point)	PS-04918	AT045	 Radar station	A - 215
Railway / intact / broad, standard / electrified / >= 2 tracks (line)	PS-04383	AN010		A - 216
Railway / intact / broad, standard / electrified / 1 track (line)	PS-04382	AN010		A - 217
Railway / intact / narrow / electrified / >= 2 tracks (line)	PS-04385	AN010		A - 218
Railway / intact / narrow / electrified / 1 track (line)	PS-04384	AN010		A - 219

Symbol	Number	Feature Code	Sample Graphic	Page
Railway / intact / broad, standard / non-electrified / >= 2 tracks (line)	PS-04378	AN010		A - 220
Railway / intact / broad, standard / non-electrified / 1 track (line)	PS-04377	AN010		A - 222
Railway / intact / narrow / non-electrified / >= 2 tracks (line)	PS-04395	AN010		A - 223
Railway / intact / narrow / non-electrified / 1 track (line)	PS-04394	AN010		A - 224
Railway / not intact / broad, standard / electrified / >= 2 tracks (line)	PS-04391	AN010		A - 225
Railway / not intact / broad, standard / electrified / 1 track (line)	PS-04390	AN010		A - 226
Railway / not intact / narrow / electrified / >= 2 tracks (line)	PS-04393	AN010		A - 227

Symbol	Number	Feature Code	Sample Graphic	Page
Railway / not intact / narrow / electrified / 1 track (line)	PS-04392	AN010		A - 228
Railway / not intact / broad, standard / non-electrified / >= 2 tracks (line)	PS-04387	AN010		A - 229
Railway / not intact / broad, standard / non-electrified / 1 track (line)	PS-04386	AN010		A - 230
Railway / not intact / narrow / non-electrified / >= 2 tracks (line)	PS-04389	AN010		A - 231
Railway / not intact / narrow / non-electrified / 1 track (line)	PS-04388	AN010		A - 233
Railway / intact / railway in road (line)	PS-04379	AN010		A - 234
Railway / not intact / railway in road (line)	PS-04439	AN010		A - 234
Railway / intact / carline (line)	PS-04380	AN010		A - 235

Symbol	Number	Feature Code	Sample Graphic	Page
Railway / not intact / carline (line)	PS-04438	AN010	(CONSTRUCTION) + + + + + + + + + +	A - 236
Railway / dismantled, destroyed (line)	PS-04381	AN010	Dismantled railway - - - - -	A - 237
Railway Sidetrack / intact / broad, standard / electrified (line)	PS-04124	AN050	— F   — F   — F	A - 237
Railway Sidetrack / intact / narrow / electrified (line)	PS-04125	AN050	— F   — F   — F	A - 238
Railway Sidetrack / intact / broad, standard / non-electrified (line)	PS-04122	AN050	—   —   —   —   —	A - 239
Railway Sidetrack / intact / narrow / non-electrified (line)	PS-04123	AN050	—   —   —   —   —	A - 239
Railway Sidetrack / not intact / broad, standard / electrified (line)	PS-04442	AN050	— F - - - F - - - F	A - 240
Railway Sidetrack / not intact / narrow / electrified (line)	PS-04443	AN050	— F - - - F - - - F	A - 241

Symbol	Number	Feature Code	Sample Graphic	Page
Railway Sidetrack / not intact / broad, standard / non-electrified (line)	PS-04440	AN050		A - 241
Railway Sidetrack / not intact / narrow / non-electrified (line)	PS-04441	AN050		A - 242
Railway Sidetrack / intact / railway in road (line)	PS-04953	AN050		A - 242
Railway Sidetrack / not intact / railway in road (line)	PS-04954	AN050		A - 243
Railway Sidetrack / dismantled, destroyed (line)	PS-04919	AN050		A - 244
Railway Turntable / all (point)	PS-04127	AN075		A - 244
Railway Yard / all (area)	PS-04126	AN060		A - 245
Rapids / all (area)	PS-04197	BH120		A - 245







Symbol	Number	Feature Code	Sample Graphic	Page
Rapids / all (line)	PS-04198	BH120	 Rapids	A - 246
Rapids / all (point)	PS-04199	BH120	 Rapids	A - 247
Recreational Pier / all (area)	PS-04063	AK190	 Pier	A - 247
Recreational Pier / all (line)	PS-04064	AK190	 Pier	A - 248
Recycling Site / all (area)	PS-04279	AB010	 Recycling site	A - 248
Reef / exposed (area)	PS-04663	BD120		A - 249
Reef / exposed (line)	PS-04662	BD120		A - 250
Reef / exposed (point)	PS-04661	BD120		A - 250
Reservoir / intact / perennial (area)	PS-04785	BH130		A - 251

Symbol	Number	Feature Code	Sample Graphic	Page
Reservoir / intact / intermittent, dry (area)	PS-04786	BH130		A - 252
Reservoir / not intact (area)	PS-04787	BH130		A - 252
Rice Field / all (area)	PS-04200	BH135		A - 253
Rig / non-obstruction (point)	PS-04272	AA040		A - 254
River / perennial (area)	PS-04202	BH140		A - 254
River / intermittent, dry (area)	PS-04203	BH140		A - 255
River / perennial (line)	PS-04204	BH140		A - 256
River / intermittent, dry (line)	PS-04205	BH140		A - 256
River Flow Arrow (point)	PS-04649	No Code		A - 257

Symbol	Number	Feature Code	Sample Graphic	Page
Road / intact / divided / very wide median (line)	PS-04877	AP030		A - 257
Road / intact / divided / wide median (curve)	PS-04570	AP030		A - 258
Road / intact / divided / narrow median (line)	PS-04369	AP030		A - 260
Road / intact / all weather / hard surface / no median / >= 4 lanes / primary (line)	PS-04368	AP030		A - 261
Road / intact / all weather / hard surface / no median / >= 4 lanes / secondary (line)	PS-04373	AP030		A - 262
Road / intact / all weather / hard surface / no median / 2 or 3 lanes / primary (line)	PS-04720	AP030		A - 264
Road / intact / all weather / hard surface / no median / 2 or 3 lanes / secondary (line)	PS-04722	AP030		A - 265
Road / intact / all weather / hard surface / no median / 1 lane / primary (line)	PS-04367	AP030		A - 266









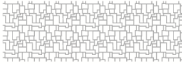

Symbol	Number	Feature Code	Sample Graphic	Page
Road / intact / all weather / hard surface / no median / 1 lane / secondary (line)	PS-04372	AP030		A - 267
Road / intact / all weather / loose surface / no median / >= 4 lanes / primary (line)	PS-04371	AP030		A - 268
Road / intact / all weather / loose surface / no median / >= 4 lanes / secondary (line)	PS-04376	AP030		A - 269
Road / intact / all weather / loose surface / no median / 2 or 3 lanes / primary (line)	PS-04721	AP030		A - 270
Road / intact / all weather / loose surface / no median / 2 or 3 lanes / secondary (line)	PS-04723	AP030		A - 272
Road / intact / all weather / loose surface / no median / 1 lane / primary (line)	PS-04370	AP030		A - 273
Road / intact / all weather / loose surface / no median / 1 lane / secondary (line)	PS-04375	AP030		A - 274
Road / intact / fair weather (line)	PS-04366	AP030		A - 275

Symbol	Number	Feature Code	Sample Graphic	Page
Road / intact / street / hard surface (line)	PS-04573	AP030		A - 276
Road / intact / street / loose surface (line)	PS-04690	AP030		A - 276
Road / not intact / median (line)	PS-04572	AP030		A - 277
Road / not intact / no median (line)	PS-04574	AP030		A - 278
Road Route Marker / international (point)	PS-04638	No Code		A - 279
Road Route Marker / national motorway (point)	PS-04623	No Code		A - 279
Road Route Marker / national (point)	PS-04639	No Code		A - 280
Road Route Marker / local, secondary (point)	PS-04640	No Code		A - 281
Roadside Rest Area / all (area)	PS-04150	AQ135		A - 281

Symbol	Number	Feature Code	Sample Graphic	Page
Roadside Rest Area / intact (point)	PS-04604	AQ135	 Rest area	A - 282
Roadside Rest Area / not intact (point)	PS-04920	AQ135	 Rest area	A - 282
Rock Formation / all (area)	PS-04256	DB160		A - 283
Rock Formation / all (line)	PS-04088	DB160		A - 284
Rock Formation / all (point)	PS-04257	DB160		A - 284
Roundhouse / all (area)	PS-04605	AN076	 Roundhouse	A - 285
Roundhouse / all (point)	PS-04606	AN076	 Roundhouse	A - 286
Ruins / all (area)	PS-04092	AL200	 Ruins	A - 286
Ruins / all (point)	PS-04093	AL200		A - 287

Symbol	Number	Feature Code	Sample Graphic	Page
Runway / intact (area)	PS-04428	GB055	 Hard surface	A - 287
Runway / not intact (area)	PS-04951	GB055	 Surface unknown	A - 288
Sabkha / all (area)	PS-04209	BH160		A - 289
Salt Evaporator / all (area)	PS-04208	BH155		A - 290
Salt Evaporator / all (point)	PS-04607	BH155	 Salt evaporator	A - 290
Salt Flat / all (area)	PS-04608	BH150	 Salt flat	A - 291
Sand Dunes / unknown (area)	PS-04258	DB170	 Dunes	A - 292
Sand Dunes / crescent (area)	PS-04259	DB170		A - 292
Sand Dunes / dome (area)	PS-04264	DB170		A - 293









Symbol	Number	Feature Code	Sample Graphic	Page
Sand Dunes / transverse (area)	PS-04260	DB170		A - 293
Sand Dunes / linear (area)	PS-04261	DB170		A - 294
Sand Dunes / ripple (area)	PS-04262	DB170		A - 294
Sand Dunes / star (area)	PS-04263	DB170		A - 295
Seawall / all (line)	PS-04748	BB230		A - 295
Settlement / intact (area)	PS-04085	AL105		A - 296
Settlement / not intact (area)	PS-04053	AL105		A - 297
Settlement / all (point)	PS-04086	AL105	Taos Pueblo	A - 297
Settling Pond / all (area)	PS-04292	AC030		A - 298



Symbol	Number	Feature Code	Sample Graphic	Page
Settling Pond / all (point)	PS-04220	AC030		A - 298
Shanty Town / all (area)	PS-04071	AL208		A - 299
Shed / all (area)	PS-04615	AL019		A - 300
Shed / all (point)	PS-04616	AL019		A - 300
Ski Jump / non-obstruction (line)	PS-04625	AK150		A - 301
Ski Jump / obstruction (line)	PS-04928	AK150		A - 301
Ski Jump / non-obstruction (point)	PS-04626	AK150		A - 302
Ski Jump / obstruction (point)	PS-04929	AK150		A - 302
Slipway / dry (area)	PS-04750	BB240		A - 303

Symbol	Number	Feature Code	Sample Graphic	Page
Slipway / not dry (area)	PS-04751	BB240		A - 304
Sluice Gate / all (line)	PS-04224	BI040		A - 304
Sluice Gate / all (point)	PS-04225	BI040		A - 305
Smokestack / non-obstruction (point)	PS-04301	AF010		A - 305
Snow Ice Field / all (area)	PS-04232	BJ100		A - 306
Soil Surface Region / distorted surface (area)	PS-04235	DA010		A - 306
Soil Surface Region / gravel (area)	PS-04237	DA010		A - 307
Soil Surface Region / sand (area)	PS-04238	DA010		A - 308
Soil Surface Region / other (area)	PS-04880	DA010		A - 308

Symbol	Number	Feature Code	Sample Graphic	Page
Solar Panel / all (point)	PS-04719	AD020	 Solar panel	A - 309
Spillway / all (area)	PS-04629	BH165	 Spillway	A - 310
Spillway / all (line)	PS-04630	BH165	<u>Spillway</u>	A - 310
Sports Ground / all (area)	PS-04631	AK040	 S	A - 311
Sports Ground / all (point)	PS-04632	AK040	 S	A - 311
Spot Elevation / not water (point)	PS-04322	CA030	• 305	A - 312
Spot Elevation / water (point)	PS-04613	CA030	210	A - 313
Stadium / all (area)	PS-04061	AK160	 Stadium	A - 313
Stadium / non-obstruction / intact (point)	PS-04062	AK160	 Stadium	A - 314







Symbol	Number	Feature Code	Sample Graphic	Page
Stadium / non-obstruction / not intact (point)	PS-04933	AK160		A - 315
Steep Terrain Face / all (line)	PS-04240	DB010		A - 315
Stopway / all (area)	PS-04633	GB045		A - 316
Storage Depot / all (area)	PS-04100	AM010	 Storage depot	A - 316
Storage Depot / all (point)	PS-04634	AM010	 Storage depot	A - 317
Storage Tank / non-obstruction / intact (area)	PS-04115	AM070	 Water	A - 318
Storage Tank / non-obstruction / not intact (area)	PS-04935	AM070		A - 318
Storage Tank / non-obstruction / intact / other (point)	PS-04116	AM070	 Water	A - 319

Symbol	Number	Feature Code	Sample Graphic	Page
Storage Tank / non-obstruction / not intact (point)	PS-04936	AM070		A - 320
Storage Tank / non-obstruction / water tower (point)	PS-04614	AM070		A - 320
Structural Pile / all (area)	PS-04174	BD100		A - 321
Structural Pile / all (point)	PS-04175	BD100		A - 322
Surface Bunker / all (point)	PS-04114	AM060		A - 322
Survey Point / geodetic (point)	PS-04491	ZB050		A - 323
Survey Point / non-geodetic (point)	PS-04492	ZB050		A - 324
Swamp / cypress (area)	PS-04313	ED020		A - 325

Symbol	Number	Feature Code	Sample Graphic	Page
Swamp / nipa (area)	PS-04335	ED020		A - 325
Swimming Pool / all (area)	PS-04635	AK170		A - 326
Swimming Pool / all (point)	PS-04098	AK170		A - 327
Taxiway / all (area)	PS-04321	GB075		A - 327
Test Site / all (area)	PS-04314	FA100		A - 328
Thicket / all (area)	PS-04309	EB020		A - 329
Tidal Water / all (area)	PS-04165	BA040		A - 329
Tower / non-obstruction / communication (point)	PS-04561	AL241		A - 330
Tower / non-obstruction / control (point)	PS-04133	AL241		A - 330

Symbol	Number	Feature Code	Sample Graphic	Page
Tower / non-obstruction / cooling (point)	PS-04035	AL241		A - 331
Tower / non-obstruction / light (point)	PS-04171	AL241		A - 331
Tower / non-obstruction / other (point)	PS-04096	AL241		A - 332
Tower / non-obstruction / water (point)	PS-04119	AL241		A - 332
Trail / all (line)	PS-04129	AP050		A - 333
Training Wall / all (area)	PS-04740	BB140		A - 333
Training Wall / all (line)	PS-04741	BB140		A - 334
Transportation Station / all (area)	PS-04144	AQ125		A - 334
Transportation Station / intact / railway (point)	PS-04408	AQ125		A - 335

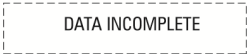



Symbol	Number	Feature Code	Sample Graphic	Page
Transportation Station / intact / other (point)	PS-04427	AQ125	▪	A - 336
Transportation Station / not intact (point)	PS-04241	AQ125	◻	A - 337
Tundra / all (area)	PS-04233	BJ110	TUNDRA	A - 337
Tunnel / road, taxiway (line)	PS-04149	AQ130	}---{	A - 338
Tunnel / railway, pedestrian, other (line)	PS-04146	AQ130	}---{	A - 338
Tunnel / inland waterway / wide (line)	PS-04147	AQ130	}---{	A - 339
Tunnel / inland waterway / narrow (line)	PS-04148	AQ130	}---{	A - 340
Vanishing Point / disappearing (point)	PS-04206	BH145	•	A - 341
Vanishing Point / dissipating (point)	PS-04207	BH145	>	A - 341

Symbol	Number	Feature Code	Sample Graphic	Page
Vehicle Lot / all (area)	PS-04151	AQ140		A - 342
Vertical Obstruction / single (point)	PS-04512	No Code		A - 342
Vertical Obstruction / multiple (point)	PS-04513	No Code		A - 343
Vineyard / all (area)	PS-04306	EA050		A - 344
Void Collection Area / all (area)	PS-04319	ZD020		A - 345
Volcano / all (area)	PS-04941	DB180	<i>Mount Rainier</i>	A - 345
Volcano / all (point)	PS-04667	DB180		A - 346
Wall / all (line)	PS-04099	AL260		A - 347
Water Aerodrome / all (area)	PS-04569	GB065		A - 347

Symbol	Number	Feature Code	Sample Graphic	Page
Water Aerodrome / all (point)	PS-04318	GB065		A - 348
Water Gate / all (line)	PS-04769	BI041		A - 349
Water Gate / all (point)	PS-04770	BI041		A - 349
Water Intake Tower / non-obstruction (point)	PS-04226	BI050		A - 350
Water Treatment Bed / all (area)	PS-04183	BH040		A - 350
Waterfall / all (line)	PS-04212	BH180		A - 351
Waterfall / all (point)	PS-04213	BH180		A - 352
Well / non-water / all (point)	PS-04273	AA050		A - 352
Well / water / perennial (point)	PS-04050	AA050		A - 353

Symbol	Number	Feature Code	Sample Graphic	Page
Well / water / intermittent, dry (point)	PS-04051	AA050		A - 355
Wind Turbine / non-obstruction (point)	PS-04054	AJ051		A - 356
Windmill / non-obstruction (point)	PS-04049	AJ050		A - 357
Wood / unknown (area)	PS-04795	EC030		A - 357
Wood / evergreen (area)	PS-04796	EC030		A - 358
Wood / deciduous (area)	PS-04797	EC030		A - 359
Wood / mixed (area)	PS-04798	EC030		A - 359
Wood / scattered (area)	PS-04799	EC030		A - 360
Wood / all (line)	PS-04800	EC030		A - 360



Symbol	Number	Feature Code	Sample Graphic	Page
Wood / all (point)	PS-04808	EC030		A - 361
Wreck / all (point)	PS-04659	BD180		A - 361
Zoo / all (area)	PS-04065	AK180		A - 362
Zoo / all (point)	PS-04511	AK180		A - 362

## Annex C – Color

This Annex presents the mapping from a specific color token to Pantone color names, the SPC ink codes, and CMYK values. The colors presented in each row of the table are approximately equivalent. This mapping allows considerable flexibility in identifying equivalent colors in a variety of methodologies. The color token name provides a link to Annex A and Annex C.

Color tokens can be replaced with different tokens if maps require different viewing conditions. This annex provides both the standard red-light readable and alternative red-light and blue/green-light readable color tokens where applicable.

The Pantone and SPC colors are normative/required because they provide the best consistency for lithographic printing. CMYK colors are provided as an alternative and are informative. CMYK values in the color tables may be altered as necessary in order to best match the intended Pantone/SPC colors.

**NOTE:** red-light and red and blue/green-light readability cannot be absolutely assured when using CMYK process printing/plotting.

Color Token Name	Color Description	Pantone Ink Code	Red-Light	Red & Blue / Green-Light	C	M	Y	K	SPC Ink Code
Black	Black	Process Black U	<input checked="" type="checkbox"/>	<input checked="" type="checkbox"/>	0	0	0	100	58600
Black-07	Black 7%	Process Black U	<input checked="" type="checkbox"/>	<input checked="" type="checkbox"/>	0	0	0	7	58600
Black-12	Black 12%	Process Black U	<input checked="" type="checkbox"/>	<input checked="" type="checkbox"/>	0	0	0	12	58600
Black-21	Black 21%	Process Black U	<input checked="" type="checkbox"/>	<input checked="" type="checkbox"/>	0	0	0	21	58600
Black-42	Black 42%	Process Black U	<input checked="" type="checkbox"/>	<input checked="" type="checkbox"/>	0	0	0	42	58600
Black-54	Black-54%	Process Black U	<input checked="" type="checkbox"/>	<input checked="" type="checkbox"/>	0	0	0	54	58600
Blue072	Blue	Blue 072 U	<input checked="" type="checkbox"/>	<input checked="" type="checkbox"/>	75	70	1	0	46351
Blue072-12	Blue 12%	Blue 072 U	<input checked="" type="checkbox"/>	<input checked="" type="checkbox"/>	9	8	0	0	46351
Blue072-42	Blue 42%	Blue 072 U	<input checked="" type="checkbox"/>	<input checked="" type="checkbox"/>	32	29	0	0	46351
Cyan	Cyan	Process Cyan U	<input checked="" type="checkbox"/>	<input type="checkbox"/>	100	0	0	0	48253
Cyan-04	Cyan 4%	Process Cyan U	<input checked="" type="checkbox"/>	<input type="checkbox"/>	4	0	0	0	48253
Cyan-31	Cyan 31%	Process Cyan U	<input checked="" type="checkbox"/>	<input type="checkbox"/>	31	0	0	0	48253
Dk-Blue662	Dark-Blue	662 U	<input type="checkbox"/>	<input checked="" type="checkbox"/>	96	63	0	12	46961
Dk-Blue662-04	Dark-Blue 4%	662 U	<input type="checkbox"/>	<input checked="" type="checkbox"/>	4	3	0	0	46961
Dk-Blue662-31	Dark-Blue 31%	662 U	<input type="checkbox"/>	<input checked="" type="checkbox"/>	30	20	0	4	46961
Dk-Brown1815	Dark Brown	1815 U	<input checked="" type="checkbox"/>	<input checked="" type="checkbox"/>	40	100	100	0	61121
Dk-Brown1815-07	Dark-Brown 7%	1815 U	<input checked="" type="checkbox"/>	<input checked="" type="checkbox"/>	3	7	7	0	61121
Dk-Brown1815-12	Dark-Brown 12%	1815 U	<input checked="" type="checkbox"/>	<input checked="" type="checkbox"/>	5	12	12	0	61121
Dk-Brown1815-21	Dark-Brown 21%	1815 U	<input checked="" type="checkbox"/>	<input checked="" type="checkbox"/>	8	21	21	0	61121
Dk-Brown1815-42	Dark-Brown 42%	1815 U	<input checked="" type="checkbox"/>	<input checked="" type="checkbox"/>	17	42	42	0	61121
Dk-Brown1815-54	Dark-Brown 54%	1815 U	<input checked="" type="checkbox"/>	<input checked="" type="checkbox"/>	22	54	54	0	61121
Green355	Green	355 U	<input type="checkbox"/>	<input checked="" type="checkbox"/>	80	0	80	7	51022
Green355-07	Green 7%	355 U	<input type="checkbox"/>	<input checked="" type="checkbox"/>	6	0	6	0	51022
Green355-12	Green 12%	355 U	<input type="checkbox"/>	<input checked="" type="checkbox"/>	10	0	10	1	51022
Green355-31	Green 31%	355 U	<input type="checkbox"/>	<input checked="" type="checkbox"/>	25	0	25	2	51022
Green355-42	Green 42%	355 U	<input type="checkbox"/>	<input checked="" type="checkbox"/>	34	0	34	3	51022
Green362	Green	362 U	<input checked="" type="checkbox"/>	<input type="checkbox"/>	76	4	76	0	52813
Green362-07	Green 7%	362 U	<input checked="" type="checkbox"/>	<input type="checkbox"/>	5	0	5	0	52813
Green362-12	Green 12%	362 U	<input checked="" type="checkbox"/>	<input type="checkbox"/>	9	0	9	0	52813
Green362-31	Green 31%	362 U	<input checked="" type="checkbox"/>	<input type="checkbox"/>	24	1	24	0	52813
Green362-42	Green 42%	362 U	<input checked="" type="checkbox"/>	<input type="checkbox"/>	32	2	32	0	52813

## Annex D – Text Characteristics

The Text Characteristics associated with the label information provided in Annex A is detailed in this Annex. The Characteristic ID provides the link to Label Rules in Annex A. The Color token name provides the link to Annex C, Color information.

**Note** – in order to meet both red-light and blue/green-light readable requirements, Cyan and Green362 text shall be changed to Dk-Blue662 and Green355 respectively.

Text Characteristic #	Color Token	Font Style	Bold	Italic	Font Size	Case	Sample Usage(s)
1	Black	Condensed	<input type="checkbox"/>	<input type="checkbox"/>	6	Mixed case	point features (descriptive), pass
3	Black	Condensed	<input type="checkbox"/>	<input type="checkbox"/>	6-16	Mixed case	vegetation
4	Black	Condensed	<input type="checkbox"/>	<input type="checkbox"/>	6-16	Lower case	vegetation
5	Black	Condensed	<input type="checkbox"/>	<input checked="" type="checkbox"/>	6	Mixed case	rock, man made features
6	Black	Condensed	<input type="checkbox"/>	<input checked="" type="checkbox"/>	6-9	Mixed case	crevice, reef (curve)
7	Black	Condensed	<input type="checkbox"/>	<input type="checkbox"/>	7-10	Mixed case	sand dunes, volcano
8	Black	Condensed	<input type="checkbox"/>	<input checked="" type="checkbox"/>	6-16	Mixed case	rock formation (surface)
10	Black	Light Condensed	<input type="checkbox"/>	<input checked="" type="checkbox"/>	6	Mixed case	trail, RR turntable
12	Black	Condensed	<input type="checkbox"/>	<input checked="" type="checkbox"/>	6-16	Upper case	island, reef (surface), cape, peninsula
14	Cyan	Condensed	<input type="checkbox"/>	<input type="checkbox"/>	6	Mixed case	pipeline, tunnel (water)
15	Blue072	Condensed	<input type="checkbox"/>	<input type="checkbox"/>	6	Mixed case	vo
16	Cyan	Condensed	<input type="checkbox"/>	<input checked="" type="checkbox"/>	6	Mixed case	named water features (blue)
17	Cyan	Condensed	<input checked="" type="checkbox"/>	<input type="checkbox"/>	10	Lower case	snow spot elev highest
18	Black	Condensed	<input checked="" type="checkbox"/>	<input type="checkbox"/>	10	Lower case	survey pt, land spot elev highest
19	Cyan	Condensed	<input type="checkbox"/>	<input checked="" type="checkbox"/>	7	Lower case	snow contour
20	Dk-Brown1815	Condensed	<input type="checkbox"/>	<input checked="" type="checkbox"/>	7	Lower case	land contour
21	Black	Condensed	<input type="checkbox"/>	<input type="checkbox"/>	8	Upper case	administrative
22	Black	Condensed	<input type="checkbox"/>	<input type="checkbox"/>	6	Lower case	point feature descriptive
23	Cyan	Condensed	<input type="checkbox"/>	<input checked="" type="checkbox"/>	6	Lower case	water features (descriptive)
24	Blue072	Condensed	<input type="checkbox"/>	<input type="checkbox"/>	7	Mixed case	aerodromes, heliport
25	Black	Condensed	<input type="checkbox"/>	<input type="checkbox"/>	8	Lower case	survey pt, land spot elev normal
26	Blue072	Condensed	<input type="checkbox"/>	<input type="checkbox"/>	7	Lower case	aerodromes, heliport, channel
27	Black	Light Condensed	<input type="checkbox"/>	<input checked="" type="checkbox"/>	6	Upper case	RR, road
28	Black	Light Condensed	<input type="checkbox"/>	<input checked="" type="checkbox"/>	6	Lower case	trail, RR (gauges, turntable & yard) descriptive
29	Blue072	Condensed	<input type="checkbox"/>	<input type="checkbox"/>	7	Upper case	aerodromes, nav aids
30	Cyan	Condensed	<input type="checkbox"/>	<input type="checkbox"/>	8	Lower case	snow, water spot elev normal
32	Cyan	Condensed	<input type="checkbox"/>	<input checked="" type="checkbox"/>	6-9	Mixed case	crevasse
33	Cyan	Condensed	<input type="checkbox"/>	<input checked="" type="checkbox"/>	7-16	Lower case	inland water descriptive
35	Black	Condensed	<input type="checkbox"/>	<input checked="" type="checkbox"/>	6	Lower case	inland water descriptive (man-made)
37	Cyan	Condensed	<input type="checkbox"/>	<input checked="" type="checkbox"/>	7-16	Upper case	river & inland water (surface)
38	Cyan	Condensed	<input type="checkbox"/>	<input checked="" type="checkbox"/>	6-16	Mixed case	other water areas
39	Black	Condensed	<input type="checkbox"/>	<input checked="" type="checkbox"/>	7-16	Upper case	mangrove, nipa, tundra
40	Black	Condensed	<input type="checkbox"/>	<input type="checkbox"/>	6-16	Upper case	data incomplete
41	Black	Condensed	<input type="checkbox"/>	<input type="checkbox"/>	6-12	Mixed case	shanty town
42	Black	Condensed	<input type="checkbox"/>	<input type="checkbox"/>	8	Mixed case	bu 5th class
45	Black	Light Condensed	<input type="checkbox"/>	<input type="checkbox"/>	6-16	Upper case	named location
46	Blue072	Condensed	<input checked="" type="checkbox"/>	<input type="checkbox"/>	6	Lower case	vo (ZVH)
47	Black	Condensed	<input checked="" type="checkbox"/>	<input type="checkbox"/>	14	Upper case	bu 1st class
48	Black	Condensed	<input checked="" type="checkbox"/>	<input type="checkbox"/>	10	Upper case	administrative boundary, bu 2nd class
49	Black	Condensed	<input checked="" type="checkbox"/>	<input type="checkbox"/>	10	Mixed case	bu 3rd class
50	Black	Condensed	<input type="checkbox"/>	<input type="checkbox"/>	10	Mixed case	bu 4th class
57	Cyan	Condensed	<input type="checkbox"/>	<input checked="" type="checkbox"/>	7-10	Mixed case	tidal water (small)
58	Cyan	Condensed	<input type="checkbox"/>	<input checked="" type="checkbox"/>	7-9	Mixed case	river (curve)
59	Cyan	Condensed	<input type="checkbox"/>	<input checked="" type="checkbox"/>	8-18	Upper case	tidal water (large)
90	Cyan	Condensed	<input type="checkbox"/>	<input checked="" type="checkbox"/>	7	Upper case	snow contour

Text Characteristic #	Color Token	Font Style	Bold	Italic	Font Size	Case	Sample Usage(s)
92	Dk-Brown1815	Condensed	<input type="checkbox"/>	<input checked="" type="checkbox"/>	7	Upper case	land contour
93	Cyan	Condensed	<input type="checkbox"/>	<input type="checkbox"/>	6	Lower case	tunnel (water)
95	Blue072	Condensed	<input type="checkbox"/>	<input type="checkbox"/>	6	Lower case	vo (HGT)
103	Black	Regular	<input checked="" type="checkbox"/>	<input checked="" type="checkbox"/>	16-18	Upper case	regional mountain range
104	Black	Regular	<input type="checkbox"/>	<input checked="" type="checkbox"/>	12-14	Upper case	small mountain range
105	Black	Regular	<input type="checkbox"/>	<input checked="" type="checkbox"/>	8-10	Mixed case	single mountain
106	Black	Light Condensed	<input type="checkbox"/>	<input checked="" type="checkbox"/>	7-8	Mixed case	small gap, hill, spur
107	Black	Light Condensed	<input type="checkbox"/>	<input checked="" type="checkbox"/>	10-18	Upper case	large terrain (plains, desert, ravine, gorge)
108	Black	Light Condensed	<input type="checkbox"/>	<input checked="" type="checkbox"/>	7-10	Mixed case	small terrain (plains, desert, ravine, gorge)
109	Dk-Brown1815	Light Condensed	<input type="checkbox"/>	<input type="checkbox"/>	6-16	Upper case	tribal name
110	Black	Condensed	<input type="checkbox"/>	<input type="checkbox"/>	10-14	Mixed case	dispersed village
111	Black	Light Condensed	<input type="checkbox"/>	<input type="checkbox"/>	10	Mixed case	scattered village
112	Black	Condensed	<input type="checkbox"/>	<input type="checkbox"/>	8	Mixed case	suburban area
113	Black	Light Condensed	<input type="checkbox"/>	<input type="checkbox"/>	8	Mixed case	farmstead
114	Black	Condensed	<input type="checkbox"/>	<input checked="" type="checkbox"/>	8	Mixed case	coastal points
115	Green362	Condensed	<input type="checkbox"/>	<input type="checkbox"/>	6	Mixed case	sports ground

## **Annex E – Area Components**

Each of the area components used in Annex A have been listed only once in this Annex.

**Area - Fill****A00002**

Description: Blue072 solid fill

Color Token: Blue072

Note: The surface geometry is filled with the solid color.

**A00005**

Description: Dk-Brown1815-42 area fill

Color Token: Dk-Brown1815-42

Screen Percent: 42%

Screen Angle: 45 degrees

**A00006**

Description: Black solid fill

Color Token: Black

Note: The surface geometry is filled with the solid color.

**A00007**

Description: Cyan-31 area fill

Color Token: Cyan-31

Screen Percent: 31%

Screen Angle: 45 degrees

**A00008**

Description: Cyan-04 area fill

Color Token: Cyan-04

Screen Percent: 4%

Screen Angle: 45 degrees

**A00009**

Description: Green362-31 area Fill

Color Token: Green362-31

Screen Percent: 31%

Screen Angle: 45 degrees

**A00048**

Description: Black-12 area fill

Color Token: Black-12

Screen Percent: 12%

Screen Angle: 15 degrees

**A00059**

Description: Green362-42 area fill

Color Token: Green362-42

Screen Percent: 42%

Screen Angle: 45 degrees

**A00060**

Description: Dk-Brown1815-07 area fill

Color Token: Dk-Brown1815-07

Screen Percent: 7%

Screen Angle: 45 degrees

**A00064**

Description: Black-12 area fill

Color Token: Black-12

Screen Percent: 12%

Screen Angle: 45 degrees

**A00101**

Description: Green362-12 area fill

Color Token: Green362-12



Screen Percent: 12%  
Screen Angle: 45 degrees

**A00121**

Description: Dk-Brown1815-21 area fill

Color Token: Dk-Brown1815-21  
Screen Percent: 21%  
Screen Angle: 45 degrees

**A00122**

Description: Dk-Brown1815-12 area fill

Color Token: Dk-Brown1815-12  
Screen Percent: 12%  
Screen Angle: 45 degrees

**A00123**

Description: Blue072-42 area fill

Color Token: Blue072-42  
Screen Percent: 42%  
Screen Angle: 45 degrees

**A00125**

Description: Blue072-12 area fill

Color Token: Blue072-12  
Screen Percent: 12%  
Screen Angle: 45 degrees

**A00127**

Description: Green362-07 area fill

Color Token: Green362-07  
Screen Percent: 7%  
Screen Angle: 45 degrees

**Area - Pattern****A00001**

Description: Black Peat Fill

Color Token: Black

Area Pattern: AP-129, see Annex I

**A00011**

Description: Green362 Deciduous Tree Fill

Color Token: Green362

Area Pattern: AP-54, see Annex I

**A00012**

Description: Green362 Evergreen Tree Fill

Color Token: Green362

Area Pattern: AP-60, see Annex I

**A00013**

Description: Green362 Mixed Tree Fill

Color Token: Green362

Area Pattern: AP-63, see Annex I

**A00014**

Description: Black-42 Shantytown Screened Fill

Color Token: Black-42  
Screen Percent: 42%  
Screen Angle: 45 degrees

Area Pattern: AP-132, see Annex I

**A00015**

Description: Cyan Land Subject to Inundation Fill

Color Token: Cyan

Area Pattern: AP-10, see Annex I

---

**A00016**

Description: Cyan Sabkha Fill

Color Token: Cyan

Area Pattern: AP-103, see Annex I

---

**A00017**

Description: Cyan Glacier Fill

Color Token: Cyan

Area Pattern: AP-104, see Annex I

---

**A00018**

Description: Cyan Bog, Marsh Fill

Color Token: Cyan

Area Pattern: AP-12, see Annex I

---

**A00019**

Description: Cyan Rice Fill

Color Token: Cyan

Area Pattern: AP-4, see Annex I

---

**A00020**

Description: Cyan Dry Drainage Fill

Color Token: Cyan

Area Pattern: AP-95, see Annex I

---

**A00024**

Description: Green362 Nipa Fill

Color Token: Green362

Area Pattern: AP-7, see Annex I

---

**A00025**

Description: Green362 Mangrove Fill

Color Token: Green362

Area Pattern: AP-8, see Annex I

---

**A00027**

Description: Green362 Scrub / Thicket Fill

Color Token: Green362

Area Pattern: AP-68, see Annex I

---

**A00028**

Description: Green362 Orchard / Plantation Fill

Color Token: Green362

Area Pattern: AP-74, see Annex I

---

**A00029**

Description: Green362 Vineyard / Hops Fill

Color Token: Green362

Area Pattern: AP-77, see Annex I

---

**A00030**

Description: Dk-Brown1815-54 Distorted Surface Screened Fill

Color Token: Dk-Brown1815-54

Screen Percent: 54%

Screen Angle: 45 degrees

Area Pattern: AP-103, see Annex I

---

**A00031**

Description: Dk-Brown1815 Crescent Sand Dunes Fill

Color Token: Dk-Brown1815

Area Pattern: AP-108, see Annex I

---

**A00032**

Description: Dk-Brown1815 Ripple Sand Dunes Fill

Color Token: Dk-Brown1815

Area Pattern: AP-112, see Annex I

---

**A00033**

Description: Dk-Brown1815 Star Sand Dunes Fill

Color Token: Dk-Brown1815

Area Pattern: AP-120, see Annex I

---

**A00034**

Description: Dk-Brown1815 Transverse Sand Dunes Fill

Color Token: Dk-Brown1815

Area Pattern: AP-127, see Annex I

---

**A00035**

Description: Dk-Brown1815 Sand Fill

Color Token: Dk-Brown1815

Area Pattern: AP-95, see Annex I

---

**A00036**

Description: Dk-Brown1815 Gravel Fill

Color Token: Dk-Brown1815

Area Pattern: AP-99, see Annex I

---

**A00042**

Description: Dk-Brown1815 Dome Sand Dunes Fill

Color Token: Dk-Brown1815

Area Pattern: AP-126, see Annex I

---

**A00043**

Description: Dk-Brown1815 Linear Sand Dunes Fill

Color Token: Dk-Brown1815

Area Pattern: AP-118, see Annex I

---

**A00044**

Description: Cyan Salt Evaporator Fill

Color Token: Cyan

Area Pattern: No existing MIL\_STD\_2410 area pattern. See Annex I for detailed drawing instructions.

---

**A00047**

Description: Green362 Scattered Trees Fill

Color Token: Green362

Area Pattern: AP-44, see Annex I

---

**A00050**

Description: Green362 Cane Fill

Color Token: Green362

Area Pattern: AP-86, see Annex I

---

**A00061**

Description: Dk-Brown1815 Diagonal Line Fill

Color Token: Dk-Brown1815

Area Pattern: LP-3, see Annex I

---

**A00062**

Description: Cyan Diagonal Line Fill

Color Token: Cyan

Area Pattern: LP-3, see Annex I

---

**A00063**

Description: Dk-Brown1815-54 Not Intact BUA Screened Fill

Color Token: Dk-Brown1815-54

Screen Percent: 54%

Screen Angle: 45 degrees

Area Pattern: LP-6, see Annex I

---

**A00065**

Description: Cyan Rapids Pattern

Color Token: Cyan

Area Pattern: AP-105, see Annex I

---

**A00118**

Description: Green362 Cropland dot fill

Color Token: Green362

Area Pattern: No existing MIL\_STD\_2410 area pattern. See Annex I for detailed drawing instructions.

---

**A00124**

Description: Green362 Greenhouse Fill

Color Token: Green362

Area Pattern: LP-6, see Annex I

---

**A00126**

Description: Green362 Grassland Fill

Color Token: Green362

Area Pattern: No existing MIL\_STD\_2410 area pattern. See Annex I for detailed drawing instructions.

---

## **Annex F – Line Components**

Each of the line components used in Annex A have been listed only once in this Annex.

**Line - Simple****L00005**

Description: Blue072 0.4mm Solid Line

Color Token: Blue072

Lineweight: 0.4mm

**L00006**

Description: Blue072 0.73mm Solid Line

Color Token: Blue072

Lineweight: 0.73mm

**L00007**

Description: Black 0.1mm Solid Line

Color Token: Black

Lineweight: 0.1mm

**L00008**

Description: Black 0.15mm Solid Line

Color Token: Black

Lineweight: 0.15mm

**L00009**

Description: Black 0.2mm Solid Line

Color Token: Black

Lineweight: 0.2mm

**L00010**

Description: Black 0.25mm Solid Line

Color Token: Black

Lineweight: 0.25mm

**L00011**

Description: Black 0.3mm Solid Line

Color Token: Black

Lineweight: 0.3mm

**L00013**

Description: Black 0.4mm Solid Line

Color Token: Black

Lineweight: 0.4mm

**L00014**

Description: Black 0.5mm Solid Line

Color Token: Black

Lineweight: 0.5mm

**L00015**

Description: Cyan 0.2mm Solid Line

Color Token: Cyan

Lineweight: 0.2mm

**L00016**

Description: Cyan 0.3mm Solid Line

Color Token: Cyan

Lineweight: 0.3mm

**L00017**

Description: Cyan 0.4mm Solid Line

Color Token: Cyan

Lineweight: 0.4mm

**L00019**

Description: Two parallel Black 0.3mm Solid Lines

Color Token: Black

Lineweight: 0.3mm

Note: Spacing is variable based on the width of the overpassing feature.

**L00021**

Description: Green362 0.2mm Solid Line

Color Token: Green362

Lineweight: 0.2mm

**L00023**

Description: Dk-Brown1815 0.2mm Solid Line

Color Token: Dk-Brown1815

Lineweight: 0.2mm

**L00024**

Description: Dk-Brown1815 0.25mm Solid Line

Color Token: Dk-Brown1815

Lineweight: 0.25mm

**L00105**

Description: Dk-Brown1815 0.3mm Solid Line

Color Token: Dk-Brown1815

Lineweight: 0.3mm

**L00107**

Description: Dk-Brown1815 0.1mm Solid Line

Color Token: Dk-Brown1815

Lineweight: 0.1mm

**L00108**

Description: Cyan 0.1mm Solid Line

Color Token: Cyan

Lineweight: 0.1mm

**L00123**

Description: Dk-Brown1815-54 2.0mm Screened Line

Color Token: Dk-Brown1815-54

Lineweight: 2.0mm

Screen Angle: 60 degrees

Screen Percent: 54%

**L00126**

Description: Dk-Brown1815-42 2.0mm Screened Line

Color Token: Dk-Brown1815-42

Lineweight: 2.0mm

Screen Angle: 60 degrees

Screen Percent: 42%

**L00145**

Description: 0mm Line weight line. This is a place holder for lines that do not have any line component only a point element at each end of the line.

Color Token: N/A

Lineweight: 0.0mm

**L00153**

Description: Black 0.6mm Solid Line

Color Token: Black

Lineweight: 0.6mm

**L00156**

Description: Dk-Brown1815 0.5mm Solid Line

Color Token: Dk-Brown1815

Lineweight: 0.5mm

---

**L00159**

Description: Dk-Brown1815 0.6mm Solid Line

Color Token: Dk-Brown1815

Lineweight: 0.6mm

---

**L00166**

Description: PaperWhite 0.3mm Solid Line

Color Token: PaperWhite

Lineweight: 0.3mm

---

**L00182**

Description: PaperWhite 0.6mm Solid Line

Color Token: PaperWhite

Lineweight: 0.6mm

---

**L00183**

Description: PaperWhite 0.8mm Solid Line

Color Token: PaperWhite

Lineweight: 0.8mm

---

**L00186**

Description: PaperWhite 0.5mm Solid Line

Color Token: PaperWhite

Lineweight: 0.5mm

---

**L00195**

Description: Dk-Brown1815 0.4mm Solid Line

Color Token: Dk-Brown1815

Lineweight: 0.4mm

---

**L00200**

Description: Black 1.5mm Solid Line

Color Token: Black

Lineweight: 1.5mm

---

**L00217**

Description: Blue072 0.1mm Solid Line

Color Token: Blue072

Lineweight: 0.1mm

---

**L00219**

Description: Black 1.45mm Solid Line

Color Token: Black

Lineweight: 1.45mm

---

**L00220**

Description: Dk-Brown1815 1.15mm Solid Line

Color Token: Dk-Brown1815

Lineweight: 1.15mm

---

**L00221**

Description: Black 0.55mm Solid Line

Color Token: Black

Lineweight: 0.55mm

---

**L00222**

Description: PaperWhite 0.25mm Solid Line

Color Token: PaperWhite

MGCP Portrayal Standard, Annex F (v2.0.1)



Lineweight: 0.25mm

---

**L00231**

Description: PaperWhite 0.45mm Solid Line

Color Token: PaperWhite

Lineweight: 0.45mm

---

**L00232**

Description: Black 0.75mm Solid Line

Color Token: Black

Lineweight: 0.75mm

---

**L00240**

Description: Dk-Brown1815 0.15mm Solid Line

Color Token: Dk-Brown1815

Lineweight: 0.15mm

---

**L00241**

Description: Two parallel Dk-Brown1815 0.15mm Solid Lines

Color Token: Dk-Brown1815

Lineweight: 0.15mm

**Note:** Spacing is variable based on the width of the overpassing feature. The minimum space between each line and the linear portion of the over passing feature shall be 0.2 mm.

---

**L00247**

Description: Two parallel Dk-Brown1815 0.3mm Solid Lines

Color Token: Dk-Brown1815

Lineweight: 0.3mm

**Note:** Spacing is variable based on the width of the overpassing feature.

---

**L00248**

Description: Cyan 0.25mm Solid Line

Color Token: Cyan

Lineweight: 0.25mm

---

**L00361**

Description: Green362 0.15mm Solid Line

Color Token: Green362

Lineweight: 0.15mm

---

**L00374**

Description: Dk-Brown1815-54 0.6mm Screened Line

Color Token: Dk-Brown1815-54

Lineweight: 0.6mm

Screen Angle: 45 degrees

Screen Percent: 54%

---

**L00376**

Description: Dk-Brown1815-54 0.5mm Screened Line

Color Token: Dk-Brown1815-54

Lineweight: 0.5mm

Screen Angle: 45 degrees

Screen Percent: 54%

---

**L00387**

Description: Dk-Brown1815-54 0.3mm Screened Line

Color Token: Dk-Brown1815-54

Lineweight: 0.3mm

Screen Angle: 45 degrees

Screen Percent: 54%

---

**L00389**

Description: Cyan 0.9mm Solid Line

Color Token: Cyan

Lineweight: 0.9mm

**L00426**

Description: Black 0.7mm Solid Line

Color Token: Black

Lineweight: 0.7mm

**L00427**

Description: PaperWhite 0.7mm Solid Line

Color Token: PaperWhite

Lineweight: 0.7mm

**L00430**

Description: Black 1.1mm Solid Line

Color Token: Black

Lineweight: 1.1mm

**L00431**

Description: Dk-Brown1815 0.8mm Solid Line

Color Token: Dk-Brown1815

Lineweight: 0.8mm

**L00433**

Description: Black 0.9mm Solid Line

Color Token: Black

Lineweight: 0.9mm

**L00439**

Description: PaperWhite 1.1mm Solid Line

Color Token: PaperWhite

Lineweight: 1.1mm

**L00444**

Description: Dk-Brown1815-42 1.0mm Screened Line

Color Token: Dk-Brown1815-42

Lineweight: 1.0mm

Screen Angle: 60 degrees

Screen Percent: 42%

**L00445**

Description: Blue072 0.25mm Solid Line

Color Token: Blue072

Lineweight: 0.25mm

**L00451**

Description: Black surface lock "V" (0.15mm wt)

Color Token: Black

Lineweight: 0.15mm

**Note:** Each leg is equal and based on width of the surface geometry, and is connected to form a "V" at a 90 degree angle.**L00455**

Description: Black-42 1.0mm Screened Line

Color Token: Black-42

Lineweight: 1.0mm

Screen Angle: 60 degrees

Screen Percent: 42%

**Line - Styled**

**L00029**

Description: Black 0.1mm Dashed Line (0.1mm wt, 2.0mm dash, 0.5mm gap)

Color Token: Black

Lineweight: 0.1mm

Dash Length: 2.0mm

Dash Spacing: 0.5mm

**L00030**

Description: Black 0.2mm Dashed Line (0.2mm wt, 1.5mm dash, 0.5mm gap)

Color Token: Black

Lineweight: 0.2mm

Dash Length: 1.5mm

Dash Spacing: 0.5mm

**L00031**

Description: Black 0.2mm Dashed Line (0.2mm wt, 1.0mm dash, 0.5mm gap)

Color Token: Black

Lineweight: 0.2mm

Dash Length: 1.0mm

Dash Spacing: 0.5mm

**L00032**

Description: Black 0.2mm Dashed Line (0.2mm wt, 2.0mm dash, 0.5mm gap)

Color Token: Black

Lineweight: 0.2mm

Dash Length: 2.0mm

Dash Spacing: 0.5mm

**L00035**

Description: Black 0.25mm Dashed Line (0.25mm wt, 3.5mm dash, 0.5mm gap)

Color Token: Black

Lineweight: 0.25mm

Dash Length: 3.5mm

Dash Spacing: 0.5mm

**L00036**

Description: Black 0.3mm Dashed Line (0.3mm wt, 2.0mm dash, 0.5mm gap)

Color Token: Black

Lineweight: 0.3mm

Dash Length: 2.0mm

Dash Spacing: 0.5mm

**L00039**

Description: Black 0.3mm Dashed Line (0.3mm wt, 5.9mm dash, 0.5mm gap)

Color Token: Black

Lineweight: 0.3mm

Dash Length: 5.9mm

Dash Spacing: 0.5mm

**L00040**

Description: Cyan 0.2mm Dashed Line (0.2mm wt, 1.0mm dash, 0.5mm gap)

Color Token: Cyan

Lineweight: 0.2mm

Dash Length: 1.0mm

Dash Spacing: 0.5mm

**L00041**

Description: Cyan 0.2mm Dashed Line (0.2mm wt, 2.0mm dash, 0.5mm gap)

Color Token: Cyan

Lineweight: 0.2mm

Dash Length: 2.0mm

Dash Spacing: 0.5mm

**L00042**

Description: Cyan 0.2mm Dashed Line (0.2mm wt, 5.0mm dash, 0.5mm gap)

Color Token: Cyan

Lineweight: 0.2mm

Dash Length: 5.0mm

Dash Spacing: 0.5mm

**L00045**

Description: Cyan 0.4mm Dashed Line (0.4mm wt, 2.0mm dash, 0.5mm gap)

Color Token: Cyan

Lineweight: 0.4mm

Dash Length: 2.0mm

Dash Spacing: 0.5mm

**L00089**

Description: Black 0.1mm Dashed line (0.1mm wt, 1.0mm dash, 1.0mm gap)

Color Token: Black

Lineweight: 0.1mm

Dash Length: 1.0mm

Dash Spacing: 1.0mm

**L00109**

Description: Dk-Brown1815 0.1mm Dashed Line (0.1mm wt, 3.0mm dash, 0.5mm gap)

Color Token: Dk-Brown1815

Lineweight: 0.1mm      Dash Length: 3.0mm      Dash Spacing: 0.5mm

---

**L00110**

Description: Cyan 0.1mm Dashed Line (0.1mm wt, 3.0mm dash, 0.5mm gap)

Color Token: Cyan

Lineweight: 0.1mm

Dash Length: 3.0mm

Dash Spacing: 0.5mm

---

**L00117**

Description: Dk-Brown1815 0.1mm Dashed Line (0.1mm wt, 1.5mm dash, 0.5mm gap)

Color Token: Dk-Brown1815

Lineweight: 0.1mm

Dash Length: 1.5mm

Dash Spacing: 0.5mm

---

**L00118**

Description: Cyan 0.1mm Dashed Line (0.1mm wt, 1.5mm dash, 0.5mm gap)

Color Token: Cyan

Lineweight: 0.1mm

Dash Length: 1.5mm

Dash Spacing: 0.5mm

---

**L00122**

Description: Black 0.5mm Dashed Line (0.5mm wt, 7.0mm dash, 2-2.0mm dashes, 1.0mm gaps)

Color Token: Black

Lineweight: 0.5mm

Dash Length: 7.0mm

Dash Spacing: 1.0mm

Dash 2 Length: 2.0mm

Dash 2 Spacing: 1.0mm

Dash 3 Length: 2.0mm

Dash 3 Spacing: 1.0mm

Note: The line style is a 7.0mm dash, 1.0mm gap, 2.0mm dash, 1.0mm gap, 2.0mm dash, 1.0mm gap, then the pattern repeats.

---

**L00133**

Description: Black 0.3mm Dashed Line (0.3mm wt, 7.0mm dash, 3.4mm gap)

Color Token: Black

Lineweight: 0.3mm

Dash Length: 7.0mm

Dash Spacing: 3.4mm

---

**L00169**

Description: Dk-Brown1815 0.6mm Dashed Line (0.6mm wt, 3.5mm dash, 1.5mm gap)

Color Token: Dk-Brown1815

Lineweight: 0.6mm

Dash Length: 3.5mm

Dash Spacing: 1.5mm

---

**L00170**

Description: Black 0.1mm Dashed Line (0.1mm wt, 2.5mm dash, 0.5mm gap)

Color Token: Black

Lineweight: 0.1mm

Dash Length: 2.5mm

Dash Spacing: 0.5mm

---

**L00176**

Description: Dk-Brown1815 0.2mm Dashed Line (0.2mm wt, 5.0mm dash, 0.5mm gap)

Color Token: Dk-Brown1815

Lineweight: 0.2mm

Dash Length: 5.0mm

Dash Spacing: 0.5mm

---

**L00177**

Description: Dk-Brown1815 0.1mm Dashed Line (0.1mm wt, 5.0mm dash, 0.5mm gap)

Color Token: Dk-Brown1815

Lineweight: 0.1mm

Dash Length: 5.0mm

Dash Spacing: 0.5mm

---

**L00178**

Description: Cyan 0.1mm Dashed Line (0.1mm wt, 5.0mm dash, 0.5mm gap)

Color Token: Cyan

Lineweight: 0.1mm

Dash Length: 5.0mm

Dash Spacing: 0.5mm

---

**L00191**

Description: Dk-Brown1815 0.3mm Dashed Line (0.3mm wt, 3.5mm dash, 1.5mm gap)

Color Token: Dk-Brown1815

Lineweight: 0.3mm

Dash Length: 3.5mm

Dash Spacing: 1.5mm

---

**L00192**

**Description:** Dk-Brown1815 0.5mm Dashed Line (0.5mm wt, 3.5mm dash, 1.5mm gap)

**Color Token:** Dk-Brown1815

**Lineweight:** 0.5mm

**Dash Length:** 3.5mm

**Dash Spacing:** 1.5mm

---

**L00198**

**Description:** Black 0.15mm Dashed Line (0.15mm wt, 3.3mm dash, 0.5mm gap)

**Color Token:** Black

**Lineweight:** 0.15mm

**Dash Length:** 3.3mm

**Dash Spacing:** 0.5mm

---

**L00205**

**Description:** Black 0.15mm Dashed Line (0.15mm wt, 5.4mm dash, 1.0mm gap)

**Color Token:** Black

**Lineweight:** 0.15mm

**Dash Length:** 5.4mm

**Dash Spacing:** 1.0mm

---

**L00210**

**Description:** Black 0.1mm Dashed line (0.1mm wt, 1.0mm dash, 0.5mm gap)

**Color Token:** Black

**Lineweight:** 0.1mm

**Dash Length:** 1.0mm

**Dash Spacing:** 0.5mm

---

**L00213**

**Description:** Two parallel Black 0.2mm Dashed Lines (0.2mm wt, 1.0mm dash, 0.5mm gap) spaced 1.3mm apart

**Color Token:** Black

**Lineweight:** 0.2mm

**Dash Length:** 1.0mm

**Dash Spacing:** 0.5mm

**Note:** The two parallel Black 0.2mm Dashed Lines are spaced 1.3mm apart from center to center

---

**L00214**

**Description:** Two parallel Cyan 0.2mm Dashed Lines (0.2mm wt, 1.0mm dash, 0.5mm gap) spaced 1.3mm apart

**Color Token:** Cyan

**Lineweight:** 0.2mm

**Dash Length:** 1.0mm

**Dash Spacing:** 0.5mm

**Note:** The two parallel Cyan 0.2mm Dashed Lines are spaced 1.3mm apart from center to center

---

**L00230**

**Description:** Black 0.75mm Dashed Line (0.75mm wt, 5.9mm dash, 0.5mm gap)

**Color Token:** Black

**Lineweight:** 0.75mm

**Dash Length:** 5.9mm

**Dash Spacing:** 0.5mm

---

**L00235**

**Description:** Cyan 0.3mm Dashed Line (0.3mm wt, 1.0mm dash, 0.5mm gap)

**Color Token:** Cyan

**Lineweight:** 0.3mm

**Dash Length:** 1.0mm

**Dash Spacing:** 0.5mm

---

**L00237**

**Description:** Black 0.25mm Dashed Line (0.25mm wt, 5.0mm dash, 1.0mm gap)

**Color Token:** Black

**Lineweight:** 0.25mm

**Dash Length:** 5.0mm

**Dash Spacing:** 1.0mm

---

**L00243**

**Description:** Black 0.3mm Dashed Line (0.3mm wt, 4.0mm dash, 1.0mm gap)

**Color Token:** Black

**Lineweight:** 0.3mm

**Dash Length:** 4.0mm

**Dash Spacing:** 1.0mm

---

**L00246**

**Description:** Cyan 0.1mm Dashed Line (0.1mm wt, 2.0mm dash, 0.5mm gap)

**Color Token:** Cyan

**Lineweight:** 0.1mm

**Dash Length:** 2.0mm

**Dash Spacing:** 0.5mm

---

**L00253**

**Description:** Dk-Brown1815 0.5mm Dashed Line (0.5mm wt, 2-2.0mm dashes, 7.0mm dash, 1.0mm

**Color Token:** Dk-Brown1815

gaps)

Lineweight:	0.5mm	Dash Length:	2.0mm	Dash Spacing:	1.0mm
		Dash 2 Length:	2.0mm	Dash 2 Spacing:	1.0mm
		Dash 3 Length:	7.0mm	Dash 3 Spacing:	1.0mm

**Note:** The line style is a 2.0mm dash, 1.0mm gap, 2.0mm dash, 1.0mm gap, 7.0mm dash, 1.0mm gap, then the pattern repeats.

**L00368**

Description:	Green362 0.15mm Dashed Line (0.15mm wt, 1.0mm dash, 0.5mm gap)	Color Token:	Green362
Lineweight:	0.15mm	Dash Length:	1.0mm
		Dash Spacing:	0.5mm

**L00378**

Description:	Dk-Brown1815-54 0.5mm Screened Dashed Line (0.5mm wt, 3.5mm, 1.5mm gap)	Color Token:	Dk-Brown1815-54
Lineweight:	0.5mm	Dash Length:	3.5mm
Screen Angle:	45 degrees	Dash Spacing:	1.5mm
Screen Percent:	54%		

**L00382**

Description:	Dk-Brown1815-54 0.3mm Screened Dashed Line (0.3mm wt, 3.5mm, 1.5mm gap)	Color Token:	Dk-Brown1815-54
Lineweight:	0.3mm	Dash Length:	3.5mm
Screen Angle:	45 degrees	Dash Spacing:	1.5mm
Screen Percent:	54%		

**L00398**

Description:	Black 0.4mm Dashed Line (0.4mm wt, 3.0mm dash, 1.0mm gap)	Color Token:	Black
Lineweight:	0.4mm	Dash Length:	3.0mm
		Dash Spacing:	1.0mm

**L00404**

Description:	Black 0.2mm Dashed Line (0.2mm wt, 4.0mm dash, 1.0mm gap)	Color Token:	Black
Lineweight:	0.2mm	Dash Length:	4.0mm
		Dash Spacing:	1.0mm

**L00405**

Description:	Cyan 0.2mm Dashed Line (0.2mm wt, 4.0mm dash, 1.0mm gap)	Color Token:	Cyan
Lineweight:	0.2mm	Dash Length:	4.0mm
		Dash Spacing:	1.0mm

**L00428**

Description:	Black 0.7mm Dashed Line (0.7mm wt, 2.5mm dash, 0.5mm gap)	Color Token:	Black
Lineweight:	0.7mm	Dash Length:	2.5mm
		Dash Spacing:	0.5mm

**L00436**

Description:	Dk-Brown1815-54 0.6mm Screened Dashed Line (0.6mm wt, 3.5mm, 1.5mm gap)	Color Token:	Dk-Brown1815-54
Lineweight:	0.6mm	Dash Length:	3.5mm
Screen Angle:	45 degrees	Dash Spacing:	1.5mm
Screen Percent:	54%		

**L00440**

Description:	Black 1.1mm Dashed Line (1.1mm wt, 2.5mm dash, 0.5mm gap)	Color Token:	Black
Lineweight:	1.1mm	Dash Length:	2.5mm
		Dash Spacing:	0.5mm

**L00442**

Description:	Black 0.15mm Dashed Line (0.15mm wt, 3.0mm dash, 1.0mm gap)	Color Token:	Black
--------------	---	--------------	-------

Lineweight: 0.15mm      Dash Length: 3.0mm      Dash Spacing: 1.0mm

---

**L00447**

Description: Black 0.15mm Dashed Line (0.15mm wt, 2.0mm dash, 0.5mm gap)

Color Token: Black

Lineweight: 0.15mm

Dash Length: 2.0mm

Dash Spacing: 0.5mm

---

**L00448**

Description: Black 0.3mm Dashed Line (0.3mm wt, 7.0mm dash, 5.3mm gap)

Color Token: Black

Lineweight: 0.3mm

Dash Length: 7.0mm

Dash Spacing: 5.3mm

---

**L00449**

Description: Black 0.3mm Dashed Line (0.3mm wt, 7.0mm dash, 7.2mm gap)

Color Token: Black

Lineweight: 0.3mm

Dash Length: 7.0mm

Dash Spacing: 7.2mm

---

**L00450**

Description: Black 0.15mm Dashed line (0.15mm wt, 3.0mm dash, 2.0mm gap)

Color Token: Black

Lineweight: 0.15mm

Dash Length: 3.0mm

Dash Spacing: 2.0mm

---

**L00452**

Description: Black-54 0.2mm Screened Dashed Line (0.2mm wt, 1.0mm dash, 0.5mm gap)

Color Token: Black-54

Lineweight: 0.2mm

Dash Length: 1.0mm

Dash Spacing: 0.5mm

Screen Angle: 45 degrees

Screen Percent: 54%

---

## **Annex G – Point Components**

Each of the point components used in Annex A have been listed only once in this Annex.



**Point - Shape****P00001**

Description: Extraction mine intact not peat

Color Token: Black

Note: See Annex H for detailed drawing instructions.

---

**P00002**

Description: Extraction mine not intact not peat

Color Token: Black

Note: See Annex H for detailed drawing instructions.

---

**P00005**

Description: Camp/campsite

Color Token: Black

Note: See Annex H for detailed drawing instructions.

---

**P00008**

Description: Vertical obstruction

Color Token: Blue072

Note: See Annex H for detailed drawing instructions.

---

**P00010**

Description: Located object

Color Token: Black

Note: See Annex H for detailed drawing instructions.

---

**P00012**

Description: Building hospital

Color Token: Black

Note: See Annex H for detailed drawing instructions.

---

**P00013**

Description: Building Christian cross

Color Token: Black

Note: See Annex H for detailed drawing instructions.

---

**P00014**

Description: Building Islamic crescent

Color Token: Black

Note: See Annex H for detailed drawing instructions.

---

**P00016**

Description: Building school flag

Color Token: Black

Note: See Annex H for detailed drawing instructions.

---

**P00017**

Description: Building Judaism "T"

Color Token: Black

Note: See Annex H for detailed drawing instructions.

---

**P00018**

Description: Building temple

Color Token: Black

Note: See Annex H for detailed drawing instructions.

---

**P00019**

Description: Building pagoda

Color Token: Black

Note: See Annex H for detailed drawing instructions.

---

**P00020**

Description: Pylon

Color Token: Blue072

Note: See Annex H for detailed drawing instructions.

---

**P00022**

Description: Cairn

Color Token: Black

Note: See Annex H for detailed drawing instructions.

---

**P00026**

Description: Natural pool perennial

Color Token: Cyan

Note: See Annex H for detailed drawing instructions.

---

**P00027**

Description: Geothermal outlet

Color Token: Dk-Brown1815

Note: See Annex H for detailed drawing instructions.

---

**P00028**

Description: Vanishing point disappearing

Color Token: Cyan

Note: See Annex H for detailed drawing instructions.

---

**P00029**

Description: Mountain pass

Color Token: Black

Note: See Annex H for detailed drawing instructions.

---

**P00030**

Description: Tree other

Color Token: Green362

Note: See Annex H for detailed drawing instructions.

---

**P00031**

Description: Building stupa

Color Token: Black

Note: See Annex H for detailed drawing instructions.

---

**P00032**

Description: Natural pool intermittent

Color Token: Cyan

Note: See Annex H for detailed drawing instructions.

---

**P00035**

Description: Basin gate/lock

Color Token: Black

Note: See Annex H for detailed drawing instructions.

---

**P00045**

Description: Pipeline elevated "V"

Color Token: Black

Note: See Annex H for detailed drawing instructions.

---

**P00058**

Description: Pipeline water elevated "V"

Color Token: Cyan

Note: See Annex H for detailed drawing instructions.

---

**P00059**

Description: Vanishing point dissipating

Color Token: Cyan

Note: See Annex H for detailed drawing instructions.

---

**P00064**

Description: Volcano

Color Token: Dk-Brown1815

Note: See Annex H for detailed drawing instructions.

---

**P00066**

Description: Ice peak not frozen water

Color Token: Dk-Brown1815

Note: See Annex H for detailed drawing instructions.

---

**P00071**

Description: Rock formation

Color Token: Dk-Brown1815

Note: See Annex H for detailed drawing instructions.

---

**P00073**

Description: Tunnel entrance not water

Color Token: Black

Note: See Annex H for detailed drawing instructions.

---

**P00074**

Description: Tunnel entrance water

Color Token: Cyan

Note: See Annex H for detailed drawing instructions.

---

**P00075**

Description: Building Christian

Color Token: Black

Note: See Annex H for detailed drawing instructions.

---

**P00076**

Description: Building Islamic

Color Token: Black

Note: See Annex H for detailed drawing instructions.

---

**P00077**

Description: Building Judaism

Color Token: Black

Note: See Annex H for detailed drawing instructions.

---

**P00079**

Description: Railway station

Color Token: Black

Note: See Annex H for detailed drawing instructions.

---

**P00084**

Description: Extraction mine peat

Color Token: Black

Note: See Annex H for detailed drawing instructions.

---

**P00088**

Description: Swimming pool

Color Token: Black/Cyan-31

Note: See Annex H for detailed drawing instructions.

---

**P00089**

Description: Helipad at hospital

Color Token: Blue072

Note: See Annex H for detailed drawing instructions.

---

**P00090**

Description: Helipad

Color Token: Blue072

Note: See Annex H for detailed drawing instructions.

---

**P00095**

Description: Hazardous rock/reef

Color Token: Black

Note: See Annex H for detailed drawing instructions.

---

**P00101**

Description: Vertical obstruction multiple

Color Token: Blue072

Note: See Annex H for detailed drawing instructions.

---

**P00105**

Description: Lock/pedestrian bridge/sluice gate "V"

Color Token: Black

Note: See Annex H for detailed drawing instructions.

---

**P00106**

Description: Culvert double "V"

Color Token: Black

Note: See Annex H for detailed drawing instructions.

---

**P00108**

Description: Fortified building

Color Token: Black

Note: See Annex H for detailed drawing instructions.

---

**P00113**

Description: Vertical obstruction linear

Color Token: Blue072

Note: See Annex H for detailed drawing instructions.

---

**P00118**

Description: Building school

Color Token: Black

Note: See Annex H for detailed drawing instructions.

---

**P00131**

Description: Crane

Color Token: Black

Note: See Annex H for detailed drawing instructions.

---

**P00132**

Description: Building checkpoint

Color Token: Black

Note: See Annex H for detailed drawing instructions.

---

**P00133**

Description: Dish aerial

Color Token: Black

Note: See Annex H for detailed drawing instructions.

---

**P00135**

Description: Lighthouse

Color Token: Black

Note: See Annex H for detailed drawing instructions.

---

**P00136**

Description: Memorial monument

Color Token: Black

Note: See Annex H for detailed drawing instructions.

---

**P00137**

Description: Cooling tower

Color Token: Black

Note: See Annex H for detailed drawing instructions.

---

**P00138**

Description: Power substation

Color Token: Black/Blue072-42

Note: See Annex H for detailed drawing instructions.

---

**P00140**

Description: Smokestack

Color Token: Black

Note: See Annex H for detailed drawing instructions.

---

**P00141**

Description: Tower non-communication

Color Token: Black

Note: See Annex H for detailed drawing instructions.

---

**P00142**

Description: Water tower

Color Token: Black/Cyan

Note: See Annex H for detailed drawing instructions.

---

**P00143**

Description: Wind turbine

Color Token: Black

Note: See Annex H for detailed drawing instructions.

---

**P00144**

Description: Windmill

Color Token: Black

Note: See Annex H for detailed drawing instructions.

---

**P00145**

Description: Flare pipe

Color Token: Black

Note: See Annex H for detailed drawing instructions.

---

**P00148**

Description: Water intake tower

Color Token: Black

Note: See Annex H for detailed drawing instructions.

---

**P00155**

Description: Aerial/tower communication

Color Token: Black

Note: See Annex H for detailed drawing instructions.

---

**P00162**

Description: Rig inland

Color Token: Black

Note: See Annex H for detailed drawing instructions.

---

**P00163**

Description: Offshore construction point

Color Token: Black

Note: See Annex H for detailed drawing instructions.

---

**P00165**

Description: Motor vehicle station

Color Token: Black

Note: See Annex H for detailed drawing instructions.

---

**P00171**

Description: Greenhouse

Color Token: Black/Green362-42

Note: See Annex H for detailed drawing instructions.

---

**P00173**

Description: Not intact square 0.8mm

Color Token: Black/Black-12

Note: See Annex H for detailed drawing instructions.

---

**P00179**

Description: Survey point geodetic

Color Token: Black

Note: See Annex H for detailed drawing instructions.

---

**P00183**

Description: Cave mouth

Color Token: Black

Note: See Annex H for detailed drawing instructions.

---

**P00184**

Description: Building minaret

Color Token: Black

Note: See Annex H for detailed drawing instructions.

---

**P00186**

Description: Building diplomatic

Color Token: Black

Note: See Annex H for detailed drawing instructions.

---

**P00188**

Description: Bridge fixed

Color Token: Black

Note: See Annex H for detailed drawing instructions.

---

**P00195**

Description: Rapids

Color Token: Cyan

Note: See Annex H for detailed drawing instructions.

---

**P00198**

Description: Mooring mast

Color Token: Black

Note: See Annex H for detailed drawing instructions.

---

**P00200**

Description: River flow arrow

Color Token: Cyan

Note: See Annex H for detailed drawing instructions.

---

**P00201**

Description: Bridge pedestrian

Color Token: Black

Note: See Annex H for detailed drawing instructions.

---

**P00202**

Description: Bridge not fixed

Color Token: Black

Note: See Annex H for detailed drawing instructions.

---

**P00206**

Description: Wreck

Color Token: Black

Note: See Annex H for detailed drawing instructions.

---

**P00207**

Description: Reef arc

Color Token: Black-54

Note: See Annex H for detailed drawing instructions.

---

**P00208**

Description: Aqueduct/penstock/water race "V"

Color Token: Cyan

Note: See Annex H for detailed drawing instructions.

---

**P00210**

Description: Sports ground

Color Token: Green362/Green362-12

Note: See Annex H for detailed drawing instructions.

---

**P00238**

Description: Railway turntable

Color Token: Black

Note: See Annex H for detailed drawing instructions.

---



**P00253**

Description: Cemetery/tomb Christian

Color Token: Black

Note: See Annex H for detailed drawing instructions.

---

**P00254**

Description: Cemetery/tomb Islam

Color Token: Black

Note: See Annex H for detailed drawing instructions.

---

**P00255**

Description: Cemetery/tomb Judaism

Color Token: Black

Note: See Annex H for detailed drawing instructions.

---

**P00257**

Description: Water aerodrome

Color Token: Blue072

Note: See Annex H for detailed drawing instructions.

---

**P00260**

Description: Oasis

Color Token: Green362

Note: See Annex H for detailed drawing instructions.

---

**P00265**

Description: Ruins

Color Token: Black

Note: See Annex H for detailed drawing instructions.

---

**P00268**

Description: Road route marker national non-USA

Color Token: Black

Note: See Annex H for detailed drawing instructions.

---

**P00271**

Description: Cemetery/tomb other

Color Token: Black

Note: See Annex H for detailed drawing instructions.

---

**P00272**

Description: Cemetery/tomb Buddhism

Color Token: Black

Note: See Annex H for detailed drawing instructions.

---

**P00274**

Description: Ski jump

Color Token: Black

Note: See Annex H for detailed drawing instructions.

---

**P00275**

Description: Motor vehicle station symbol

Color Token: Black

Note: See Annex H for detailed drawing instructions.

---

**P00277**

Description: Railway tick narrow double

Color Token: Black

Note: See Annex H for detailed drawing instructions.

---

**P00278**

Description: Railway tick broad double

Color Token: Black

Note: See Annex H for detailed drawing instructions.

---

**P00279**

Description: Railway tick narrow electrified

Color Token: Black

Note: See Annex H for detailed drawing instructions.

---

**P00280**

Description: Railway tick broad electrified

Color Token: Black

Note: See Annex H for detailed drawing instructions.

---

**P00281**

Description: Railway tick narrow electrified double

Color Token: Black

Note: See Annex H for detailed drawing instructions.

---

**P00282**

Description: Railway tick broad electrified double

Color Token: Black

Note: See Annex H for detailed drawing instructions.

---

**P00283**

Description: Surface bunker

Color Token: Black/Dk-Brown1815

Note: See Annex H for detailed drawing instructions.

---

**P00285**

Description: Building diplomatic flag

Color Token: Black

Note: See Annex H for detailed drawing instructions.

---

**P00286**

Description: Fence "X"

Color Token: Black

Note: See Annex H for detailed drawing instructions.

---

**P00288**

Description: Settling pond

Color Token: Black/Cyan-31

Note: See Annex H for detailed drawing instructions.

**P00291**

Description: Not intact circle 0.8mm

Color Token: Black/Black-12

Note: See Annex H for detailed drawing instructions.

**P00292**

Description: Vertical obstruction pylon

Color Token: Blue072

Note: See Annex H for detailed drawing instructions.

**P00293**

Description: Not intact square 0.6mm

Color Token: Black/Black-12

Note: See Annex H for detailed drawing instructions.

**P00294**

Description: Radio aid

Color Token: Blue072

Note: See Annex H for detailed drawing instructions.

**P00295**

Description: Aircraft revetment

Color Token: Dk-Brown1815

Note: See Annex H for detailed drawing instructions.

**P00296**

Description: Building hospital symbol

Color Token: Black

Note: See Annex H for detailed drawing instructions.

**Point - Simple****P00006**

Description: Black filled square with all sides 0.8mm

Color Token: Black

Length: 0.8mm

Note: The component is a square and is filled with the solid color.

**P00007**

Description: Cyan filled square with all sides 0.8mm

Color Token: Cyan

Length: 0.8mm

Note: The component is a square and is filled with the solid color.

**P00009**

Description: Non-water well

Color Token: Black

Diameter: 1.0mm

Lineweight: 0.15mm

Note: The component is an open circle.

---

**P00038**

Description: Black 0.75mm length line with a 0.15mm lineweight

Color Token: Black

Lineweight: 0.15mm

Length: 0.75mm

---

**P00040**

Description: Qanat/Water well intermittent

Color Token: Cyan

Diameter: 1.0mm

Lineweight: 0.15mm

Note: The component is an open circle.

---

**P00041**

Description: Cyan 0.8mm diameter filled circle

Color Token: Cyan

Diameter: 0.8mm

Note: The component is a circle and is filled with the solid color.

---

**P00044**

Description: Black 1.5mm length line with a 0.15mm lineweight

Color Token: Black

Lineweight: 0.15mm

Length: 1.5mm

---

**P00047**

Description: Black 0.25mm diameter filled circle

Color Token: Black

Diameter: 0.25mm

Note: The component is a circle and is filled with the solid color.

---

**P00048**

Description: Bridge non-fixed open circle

Color Token: Black

Lineweight: 0.2mm

Note: The diameter of the open circle is variable based on the width of the overpassing feature.

---

**P00050**

Description: Black filled square with all sides 0.5mm

Color Token: Black

Length: 0.5mm

Note: The component is a square and is filled with the solid color.

---

**P00053**

Description: Black 0.8mm diameter filled circle

Color Token: Black

Diameter: 0.8mm

Note: The component is a circle and is filled with the solid color.

---

**P00055**

Description: Cyan 0.5mm length line with a 0.1mm lineweight

Color Token: Cyan

Lineweight: 0.1mm

Length: 0.5mm

---

**P00061**

Description: Cyan 1.5mm length line with a 0.2mm lineweight

Color Token: Cyan

Lineweight: 0.2mm

Length: 1.5mm

---

**P00065**

Description: Dk-Brown1815 0.5mm length line with a 0.1mm lineweight  
 Lineweight: 0.1mm

Color Token: Dk-Brown1815

---

Length: 0.5mm

---

**P00067**

Description: Dk-Brown1815 0.8mm length line with a 0.15mm lineweight  
 Lineweight: 0.15mm

Color Token: Dk-Brown1815

---

Length: 0.8mm

---

**P00069**

Description: Dk-Brown1815 1.0mm length line with a 0.2mm lineweight  
 Lineweight: 0.2mm

Color Token: Dk-Brown1815

---

Length: 1.0mm

---

**P00081**

Description: Black 0.64mm diameter filled circle  
 Diameter: 0.64mm

Color Token: Black

Note: The component is a circle and is filled with the solid color

---

**P00082**

Description: Black 0.4mm diameter filled circle  
 Diameter: 0.4mm

Color Token: Black

Note: The component is a circle and is filled with the solid color.

---

**P00103**

Description: Dolphin/Snag/Structural pile  
 Diameter: 0.8mm

Color Token: Black

Lineweight: 0.15mm

Note: The component is an open circle.

---

**P00111**

Description: Forest/curve  
 Diameter: 0.5mm

Color Token: Green362

Lineweight: 0.1mm

Note: The component is an open circle.

---

**P00125**

Description: Cyan 0.7mm diameter filled circle  
 Diameter: 0.7mm

Color Token: Cyan

Note: The component is a circle and is filled with the solid color.

---

**P00146**

Description: Green362 filled square with all sides 0.8mm  
 Length: 0.8mm

Color Token: Green362

Note: The component is a square and is filled with the solid color.

---

**P00149**

Description: Black 0.35mm length line with a 0.45mm lineweight  
 Lineweight: 0.45mm

Color Token: Black

Length: 0.35mm

---

### P00152

Description: Black 2.5mm length line with a 1.5mm lineweight

Color Token: Black

Lineweight: 1.5mm

Length: 2.5mm

---

### P00153

Description: Black 2.0mm length line with a 0.15mm lineweight

Color Token: Black

Lineweight: 0.15mm

Length: 2.0mm

---

### P00157

Description: Salt evaporator

Color Token: Cyan

Lineweight: 0.2mm

Length: 1.5mm

Note: The component is an open square.

---

### P00158

Description: Road route marker national motorway non-USA

Color Token: Black

Lineweight: 0.1mm

Length: 4.5mm long; 2.25mm wide

Note: The component is an open rectangle.

---

### P00160

Description: Road route marker local/secondary

Color Token: Black

Diameter: 3.8mm

Lineweight: 0.1mm

Note: The component is an open circle.

---

### P00167

Description: Cyan 0.25mm diameter filled circle

Color Token: Cyan

Diameter: 0.25mm

Note: The component is a circle and is filled with the solid color.

---

### P00168

Description: Holding pen

Color Token: Dk-Brown1815

Lineweight: 0.15mm

Length: 0.8mm

Note: The component is an open square.

---

### P00174

Description: Dk-Brown1815 0.5mm length line with 0.15mm lineweight

Color Token: Dk-Brown1815

Lineweight: 0.15mm

Length: 0.5mm

---

### P00175

Description: Dragons teeth

Color Token: Black

Lineweight: 0.3mm

Length: 1.0mm

Note: The component is an open square.

---

**P00193**

Description: Black 0.7mm diameter filled circle

Color Token: Black

Diameter: 0.7mm

Note: The component is a circle and is filled with the solid color.

---

**P00235**

Description: Green362 0.35mm length line with a 0.45mm lineweight

Color Token: Green362

Lineweight: 0.45mm

Length: 0.35mm

---

**P00267**

Description: Road route marker international

Color Token: Black

Lineweight: 0.2mm

Length: 4.5mm long; 2.5mm wide

Note: The component is an open rectangle.

---

**P00269**

Description: Black 1.5mm length line with a 0.4mm lineweight

Color Token: Black

Lineweight: 0.4mm

Length: 1.5mm

---

**P00270**

Description: Dk-Brown1815 1.5mm length line with a 0.4mm lineweight

Color Token: Dk-Brown1815

Lineweight: 0.4mm

Length: 1.5mm

---

**P00284**

Description: Hut

Color Token: Black

Lineweight: 0.1mm

Length: 0.6mm

Note: The component is an open square.

---

**P00287**

Description: Blue072 0.8mm diameter open circle

Color Token: Blue072

Diameter: 0.8mm

Lineweight: 0.25mm

Note: The component is an open circle.

---

## **Annex H – Detailed Drawing Instructions**

This Annex contains detailed drawing instructions for the point shape components used in Annex A for symbols that could not be easily explained in a small set of parameters. The pictures shown in this Annex are not to scale, but have been enlarged to make it easier to view the drawing. Unless otherwise noted in the Symbol Placement Instructions in Annex A, all symbol components provided in Annex H are shown in their default orientation of 0 degrees (i.e. to the south neatline).

In Annex H, there are a number of point components or symbols that have "open" or white areas. It is intended that underlying symbology (such as vegetation) would not show through any of these white openings, but rather the component would mask out underlying symbols, not allowing it to fill any of the open or white portions of the symbol. For example, the open or white portion of the Tower symbol would mask the underlying Built-up Area tint, not allowing it to fill any open portion of the Tower symbol.

See section 6.10 for Component Reference numbers in Annex H that contain an open or white area as part of the symbol.



Description: **Aerial/tower communication**

Component Ref #: P00155

Color Token: Black

Origin: Center of open circle

Overall component height: 3.45mm  
 Overall component width: 1.70mm  
 Diameter of open circle: 0.60mm  
 Lineweight of open circle: 0.10mm  
 Lineweight (all or other): 0.15mm

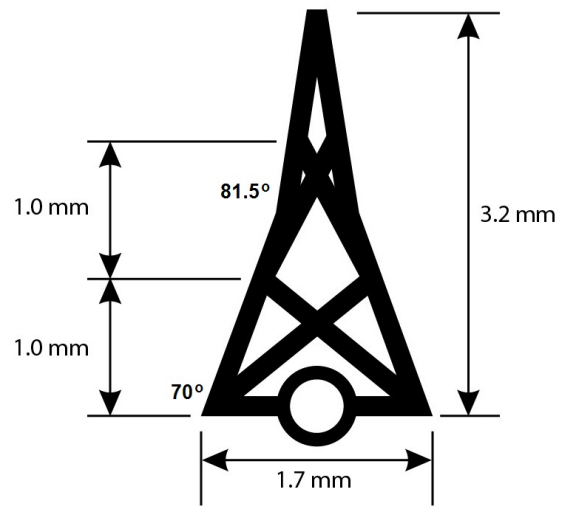

Description: **Aircraft revetment**

Component Ref #: P00295

Color Token: Dk-Brown1815

Origin: Center of symbol

Overall component height: 2.25mm  
 Overall component width: 2.25mm  
 Diameter of open circle: 1.25mm  
 Lineweight of open circle: 0.15mm  
 Length of stem or segment: 0.50mm  
 Lineweight of ticks: 0.15mm  
 Angle between elements: 90°

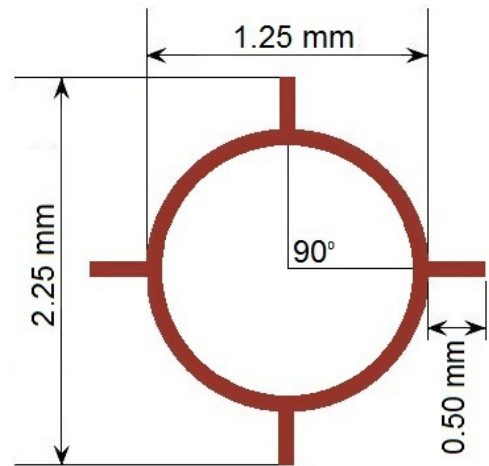

Description: **Aqueduct/penstock/water race "V"**

Component Ref #: P00208

Color Token: Cyan

Origin: Apex of "V"

Length of stem or segment: 0.90mm  
 Lineweight (all or other): 0.30mm  
 Angle between elements: 90°

Note: Apex is where the lines connect to form a "V".

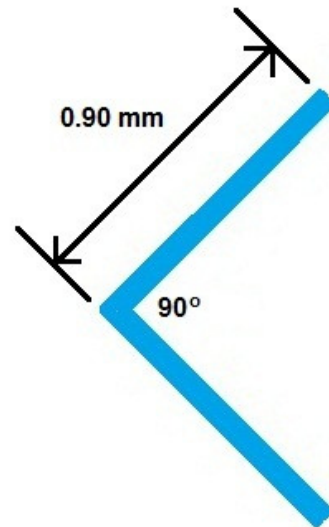

Description: **Basin gate/lock**

Component Ref #: P00035

Color Token: Black

Origin: Center of symbol

Overall component height: 1.45mm  
 Overall component width: 1.25mm  
 Length of stem or segment: 0.80mm  
 Lineweight (all or other): 0.15mm  
 Angle between elements: 90°  
 Space between elements: 0.50mm

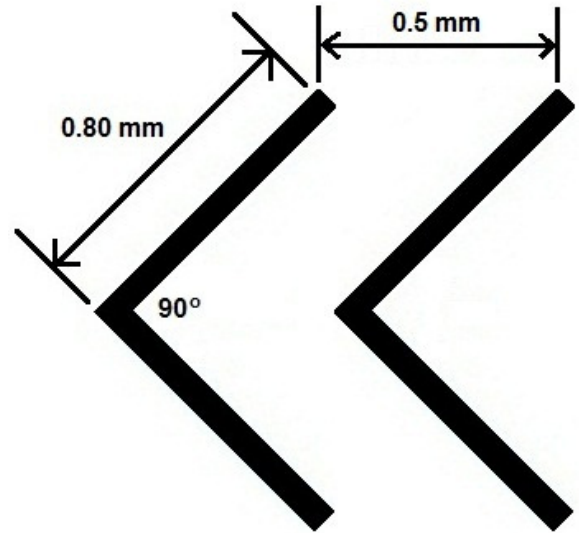

Description: **Bridge fixed**

Component Ref #: P00188

Color Token: Black

Origin: Center of symbol

Length of stem or segment: 1.50mm  
 Lineweight of stem or base: 0.30mm  
 Lineweight of ticks: 0.15mm

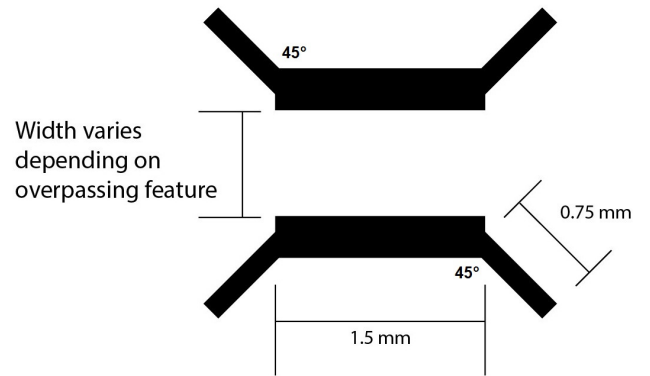

Description: **Bridge not fixed**

Component Ref #: P00202

Color Token: Black

Origin: Center of symbol

Lineweight of open circle: 0.20mm  
 Length of stem or segment: 1.50mm  
 Lineweight of stem or base: 0.30mm  
 Lineweight of ticks: 0.15mm

Note: Diameter of open circle is variable based on the width of the space between the lines.

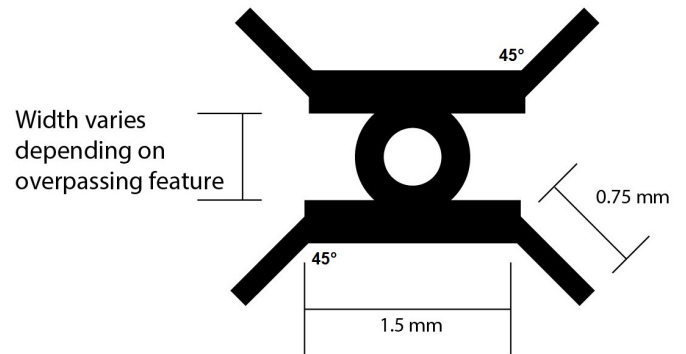

Description: **Bridge pedestrian**

Component Ref #: P00201

Color Token: Black

Origin: Center of symbol

Length of stem or segment: 1.50mm

Lineweight of ticks: 0.15mm

Lineweight (all or other): 0.30mm

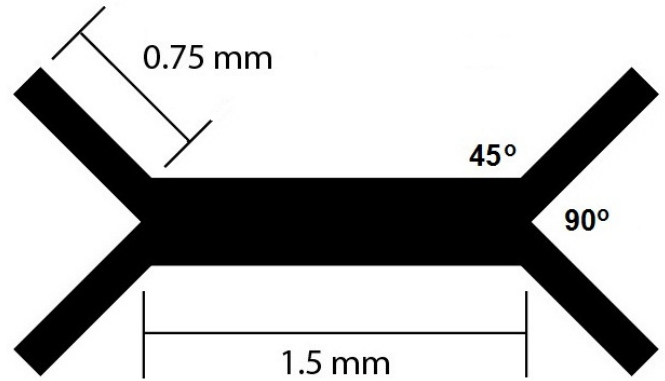

Description: **Building checkpoint**

Component Ref #: P00132

Color Token: Black

Origin: Center of symbol

Overall component height: 1.75mm

Overall component width: 1.75mm

Diameter of open circle: 1.75mm

Lineweight (all or other): 0.15mm

Space between elements: 0.20mm

Note: Horizontal lines are centered in the circle

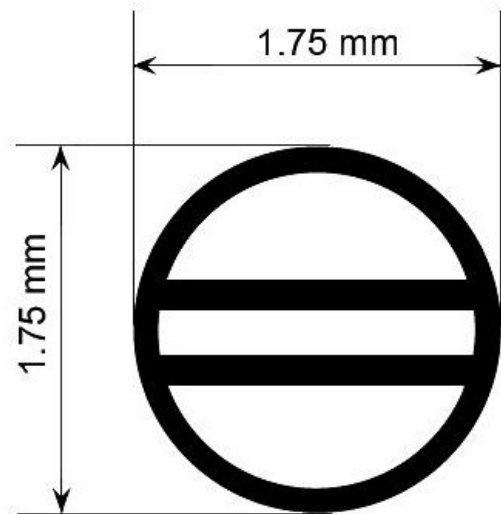

Description: **Building Christian**

Component Ref #: P00075

Color Token: Black

Origin: Center of solid square

Overall component height: 1.60mm

Overall component width: 0.80mm

Lineweight (all or other): 0.20mm

Angle between elements: 90°

Note: Solid square 0.50mm each side.

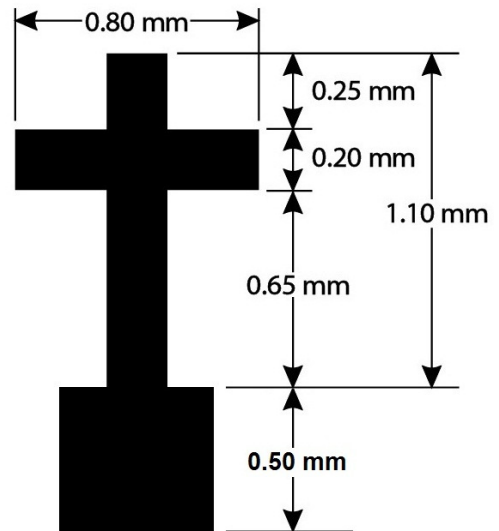

Description: **Building Christian cross**

Component Ref #: P00013 Color Token: Black

Origin: Center of base of staff

Overall component height: 1.10mm  
 Overall component width: 0.80mm  
 Lineweight (all or other): 0.20mm  
 Angle between elements: 90°

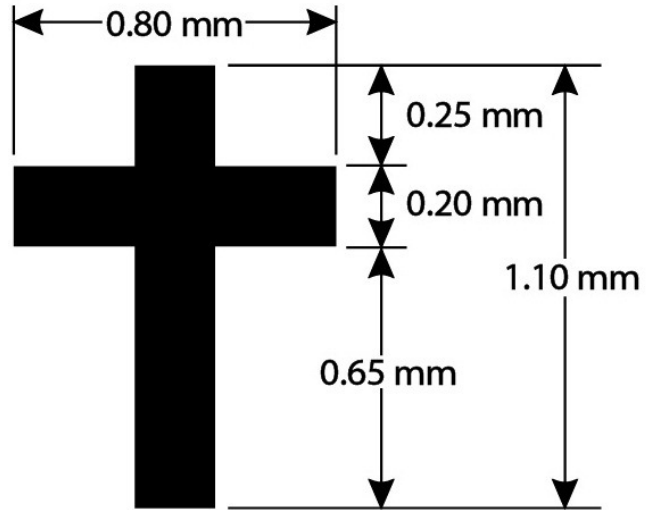

Description: **Building diplomatic**

Component Ref #: P00186 Color Token: Black

Origin: Center of solid square

Overall component height: 2.00mm  
 Overall component width: 0.90mm  
 Lineweight (all or other): 0.15mm  
 Angle between elements: 90°

Note: Solid square 0.50mm each side.

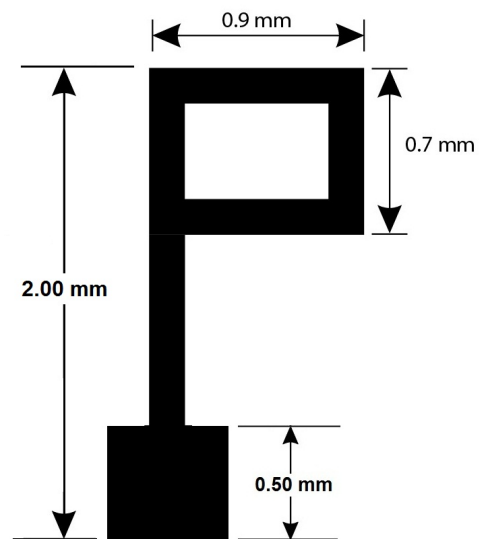

Description: **Building diplomatic flag**

Component Ref #: P00285 Color Token: Black

Origin: Center of base of staff

Overall component height: 1.50mm  
 Overall component width: 0.90mm  
 Lineweight (all or other): 0.15mm  
 Angle between elements: 90°

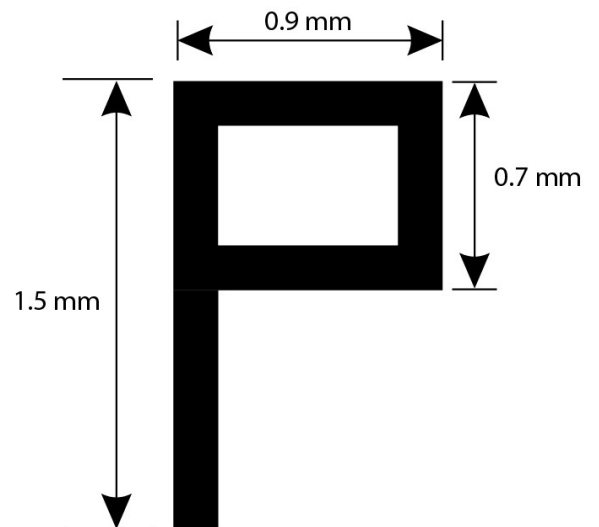

Description: **Building hospital**

Component Ref #: P00012

Color Token: Black

Origin: Center of symbol

Overall component height: 1.75mm

Overall component width: 1.75mm

Diameter of solid circle: 1.75mm

Lineweight (all or other): 0.25mm

Angle between elements: 90°

Note: White cross bars are 1.25mm centered within solid circle.

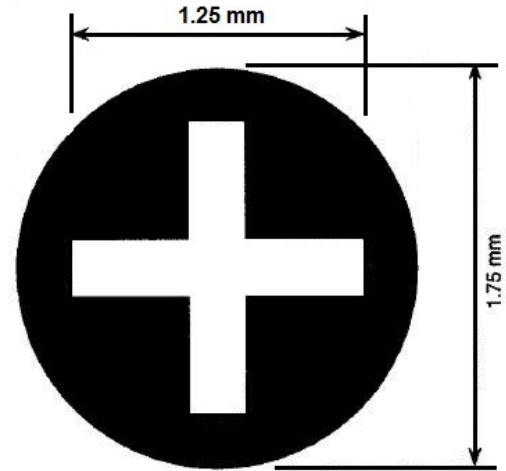

Description: **Building hospital symbol**

Component Ref #: P00296

Color Token: Black

Origin: Center of symbol

Overall component height: 2.25mm

Overall component width: 2.25mm

Diameter of solid circle: 1.75mm

Lineweight of open circle: 0.10mm

Lineweight (all or other): 0.25mm

Angle between elements: 90°

Note: White cross bars are 1.25mm centered within solid circle. Lineweight of white circle 0.15mm

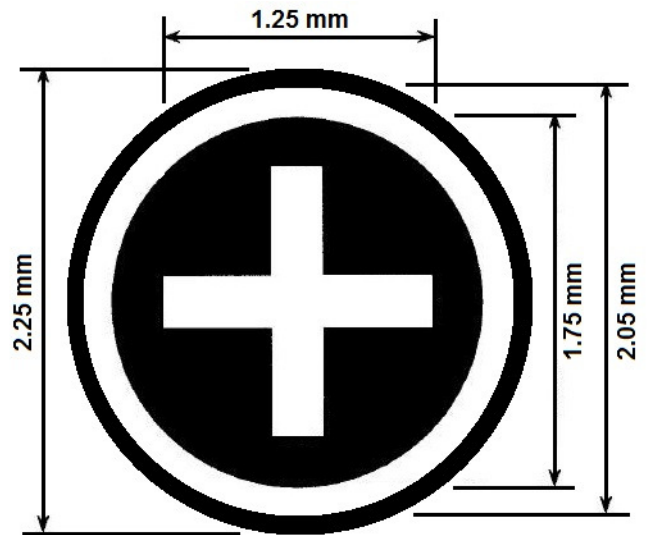

Description: **Building Islamic**

Component Ref #: P00076

Color Token: Black

Origin: Center of solid square

Overall component height: 1.60mm

Overall component width: 0.90mm

Lineweight (all or other): 0.20mm

Angle between elements: 90°

Note: Solid square 0.50mm each side.

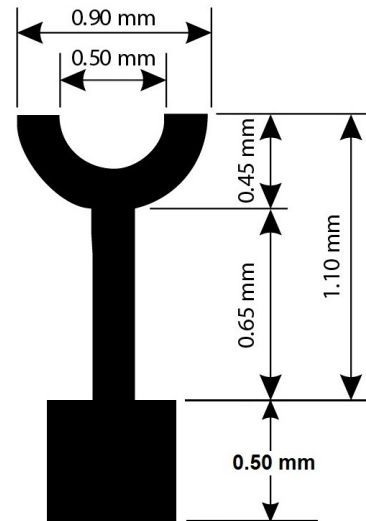

Description: **Building Islamic crescent**

Component Ref #: P00014 Color Token: Black

Origin: Center of base of staff

Overall component height: 1.10mm

Overall component width: 0.90mm

Lineweight (all or other): 0.20mm

Angle between elements: 90°

Note: Half circle is centered on staff

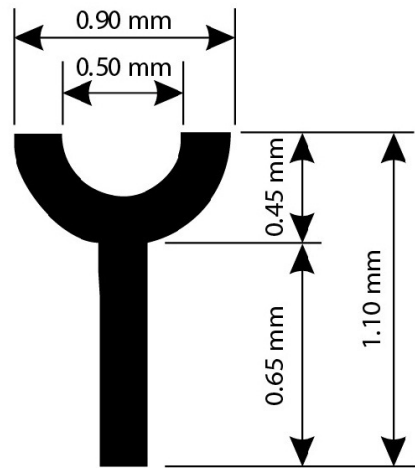

Description: **Building Judaism**

Component Ref #: P00077 Color Token: Black

Origin: Center of solid square

Overall component height: 1.60mm

Overall component width: 0.80mm

Lineweight (all or other): 0.20mm

Angle between elements: 90°

Note: Solid square 0.50mm each side.

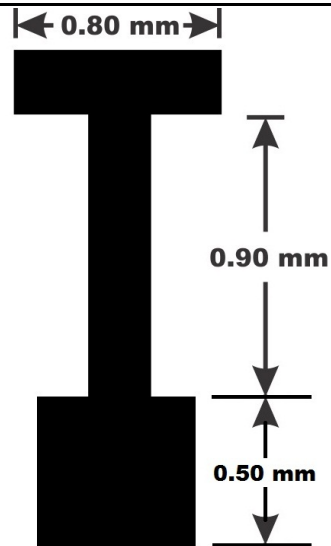

Description: **Building Judaism "T"**

Component Ref #: P00017 Color Token: Black

Origin: Center of symbol

Overall component height: 1.10mm

Overall component width: 0.80mm

Length of stem or segment: 0.90mm

Lineweight (all or other): 0.20mm

Angle between elements: 90°

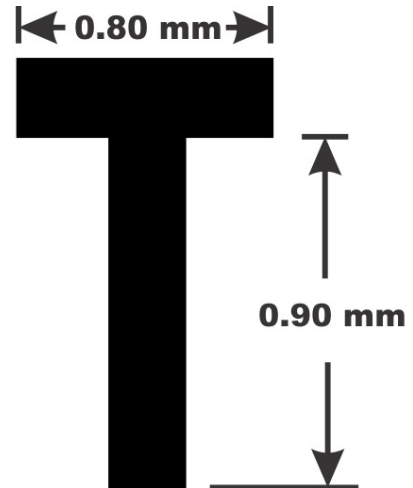

Description: **Building minaret**

Component Ref #: P00184

Color Token: Black

Origin: Center of open circle

Overall component height: 2.35mm  
 Overall component width: 1.25mm  
 Diameter of solid circle: 0.30mm  
 Diameter of open circle: 1.25mm  
 Lineweight of open circle: 0.15mm  
 Length of stem or segment: 0.2mm  
 Angle between elements: 90°

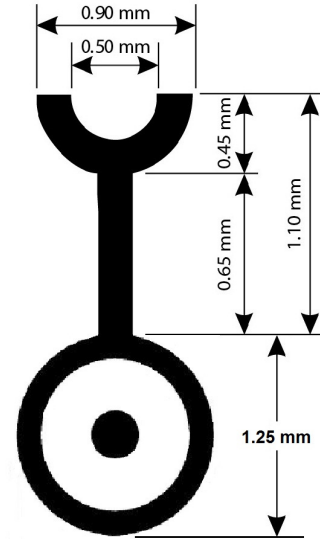

Description: **Building pagoda**

Component Ref #: P00019

Color Token: Black

Origin: Center of symbol

Overall component height: 1.65mm  
 Overall component width: 1.10mm  
 Lineweight (all or other): 0.20mm  
 Note: A white 0.40mm square is placed 0.20mm from bottom. Arc radii is 0.44mm.

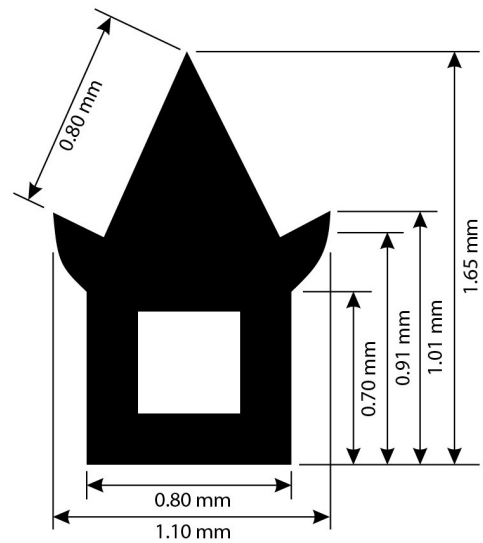

Description: **Building school**

Component Ref #: P00118

Color Token: Black

Origin: Center of solid square

Overall component height: 1.70mm  
 Overall component width: 0.90mm  
 Lineweight (all or other): 0.20mm  
 Note: Solid square 0.50mm each side.

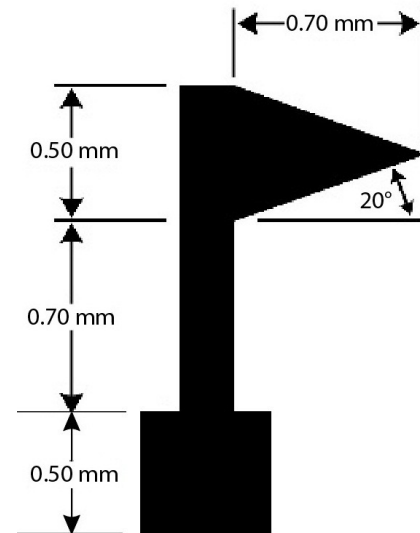

Description: **Building school flag**

Component Ref #: P00016

Color Token: Black

Origin: Center of base of staff

Overall component height: 1.20mm  
 Overall component width: 0.90mm  
 Lineweight (all or other): 0.20mm

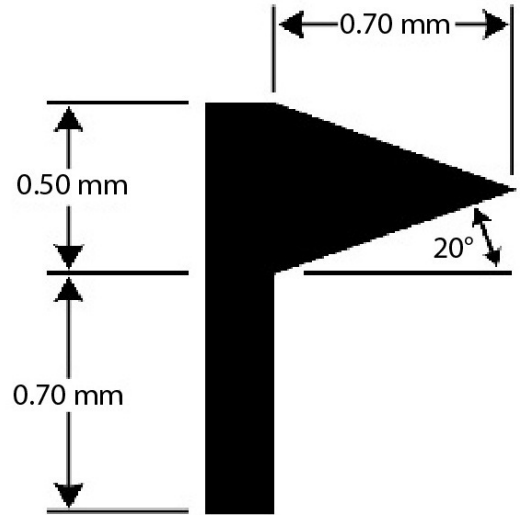

Description: **Building stupa**

Component Ref #: P00031

Color Token: Black

Origin: Center of symbol

Overall component height: 1.80mm  
 Overall component width: 1.50mm  
 Lineweight (all or other): 0.15mm  
 Grid square size: 0.10mm x 0.10mm  
 Note: Steeple top radius is 0.04mm

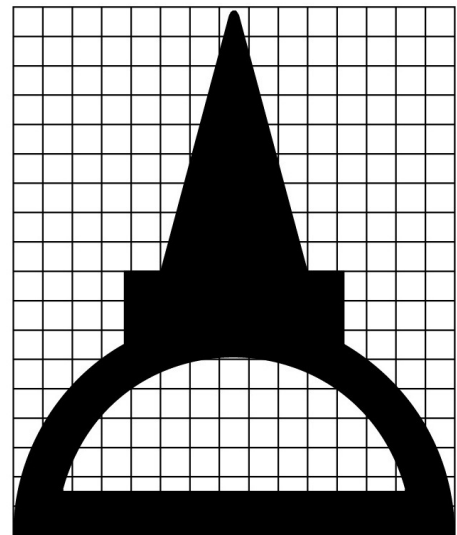

Description: **Building temple**

Component Ref #: P00018

Color Token: Black

Origin: Center of symbol

Overall component height: 1.36mm  
 Overall component width: 1.86mm  
 Lineweight (all or other): 0.20mm  
 Note: Large arc radius 0.43mm. Small arc radius 0.35mm.

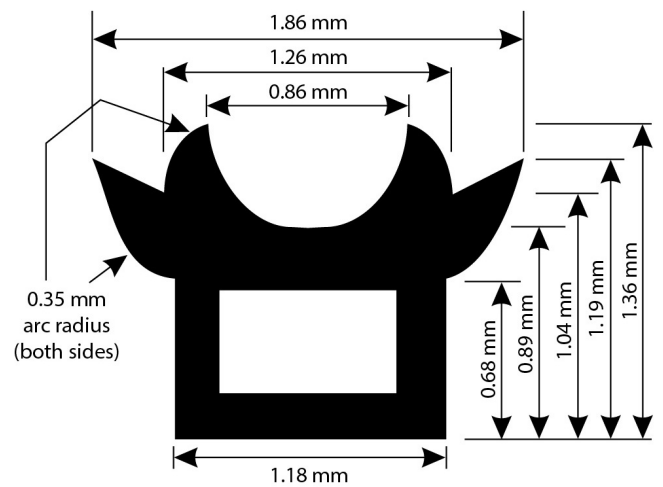



Description: **Cairn**

Component Ref #: P00022

Color Token: Black

Origin: Center of open circle

Overall component height: 1.65mm

Overall component width: 2.00mm

Diameter of open circle: 0.50mm

Lineweight of open circle: 0.10mm

Lineweight of stem or base: 0.10mm

Note: Large circle diameters is 0.90mm. Lineweight 0.13mm.

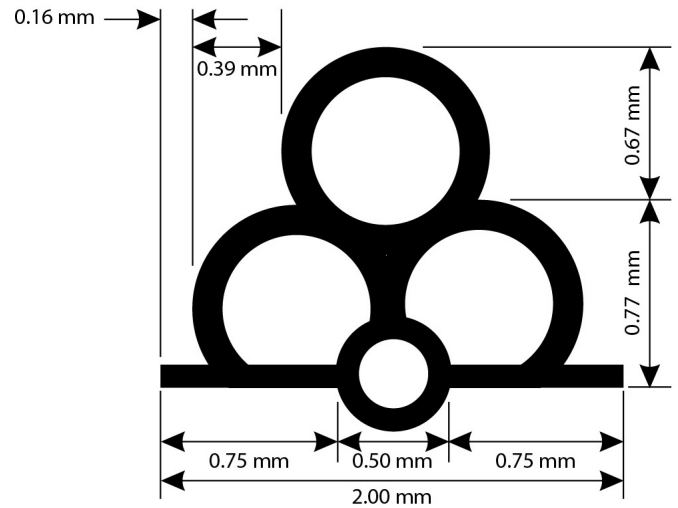

Description: **Camp/campsite**

Component Ref #: P00005

Color Token: Black

Origin: Center of symbol

Overall component height: 1.85mm

Overall component width: 1.55mm

Length of stem or segment: 2.00mm

Lineweight (all or other): 0.15mm

Angle between elements: 45°

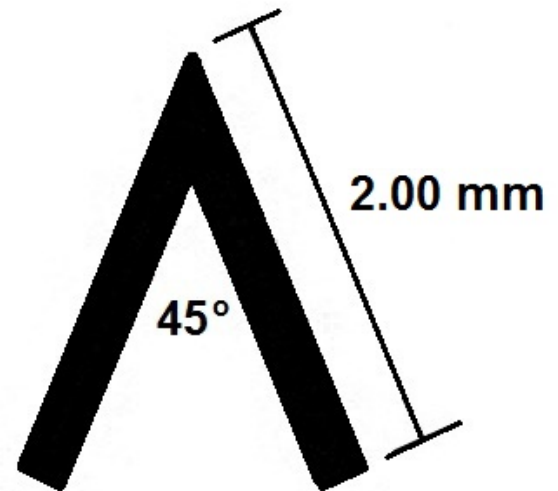

Description: **Cave mouth**

Component Ref #: P00183

Color Token: Black

Origin: Center of symbol

Overall component height: 1.10mm

Overall component width: 2.00mm

Length of stem or segment: 1.50mm

Lineweight (all or other): 0.20mm

Angle between elements: 135°

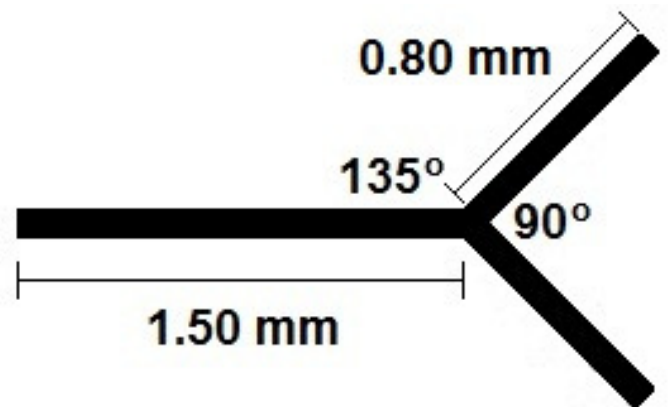

Description: **Cemetery/tomb Buddhism**

Component Ref #: P00272

Color Token: Black

Origin: Center of symbol

Overall component height: 1.00mm

Overall component width: 1.50mm

Lineweight (all or other): 0.25mm

Angle between elements: 90°

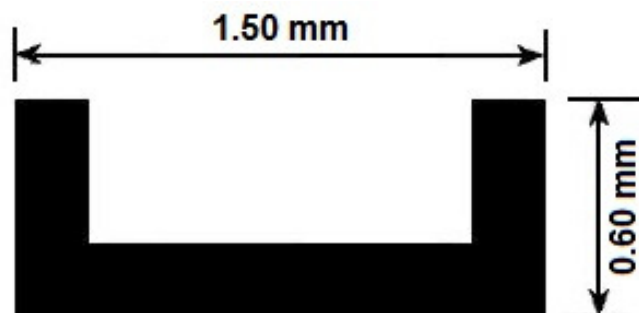

Description: **Cemetery/tomb Christian**

Component Ref #: P00253

Color Token: Black

Origin: Center of symbol

Overall component height: 2.00mm

Overall component width: 1.10mm

Lineweight (all or other): 0.25mm

Angle between elements: 90°

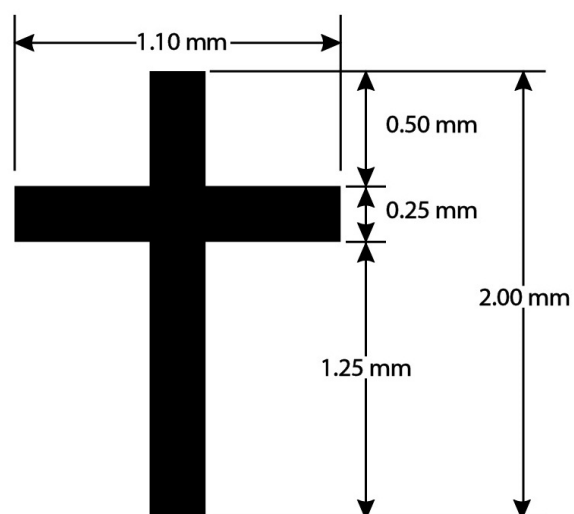

Description: **Cemetery/tomb Islam**

Component Ref #: P00254

Color Token: Black

Origin: Center of symbol

Overall component height: 2.00mm

Overall component width: 1.30mm

Lineweight (all or other): 0.25mm

Angle between elements: 90°

Note: Half circle is centered on staff

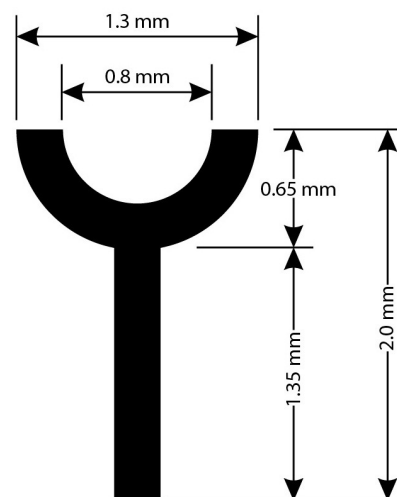

Description: **Cemetery/tomb Judaism**

Component Ref #: P00255

Color Token: Black

Origin: Center of symbol

Overall component height: 2.00mm  
 Overall component width: 0.80mm  
 Lineweight (all or other): 0.25mm  
 Angle between elements: 90°

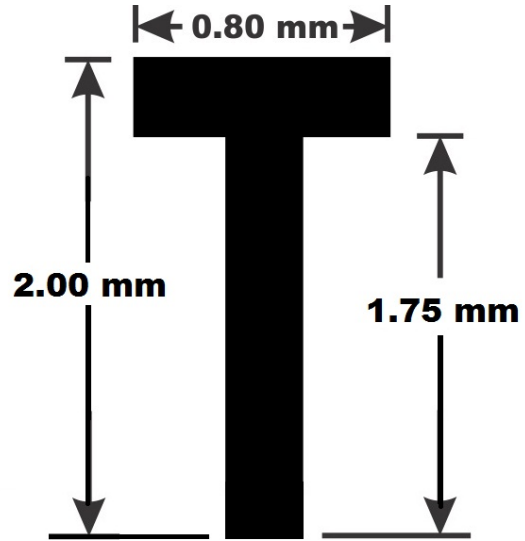

Description: **Cemetery/tomb other**

Component Ref #: P00271

Color Token: Black

Origin: Center of symbol

Overall component height: 1.45mm  
 Overall component width: 2.00mm  
 Lineweight (all or other): 0.25mm  
 Grid square size: 0.20mm x 0.20mm  
 Note: Top of symbol is the upper part of an ellipse 1.00mm wide by 1.1 mm high

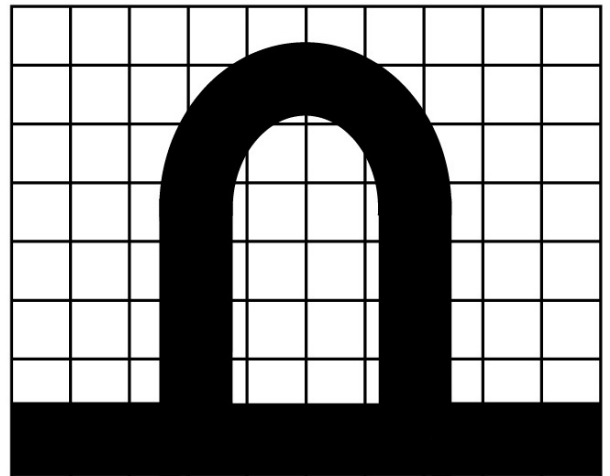

Description: **Cooling tower**

Component Ref #: P00137

Color Token: Black

Origin: Center of open circle

Overall component height: 2.50mm  
 Overall component width: 1.75mm  
 Diameter of open circle: 0.60mm  
 Lineweight of open circle: 0.10mm  
 Grid square size: 0.20mm x 0.20mm  
 Note: Width at top 1.10mm. Width at narrowest part 0.80mm. Width at bottom 1.75mm

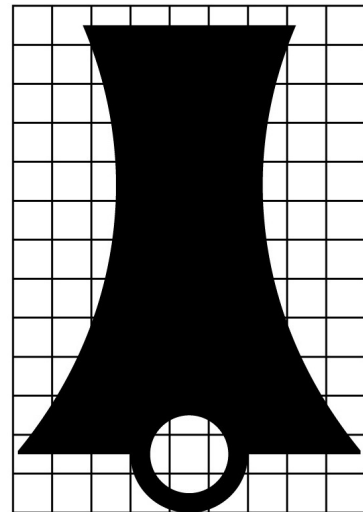

Description: **Crane**  
 Component Ref #: P00131  
 Origin: Center of open circle  
 Overall component height: 1.40mm  
 Overall component width: 1.80mm  
 Diameter of open circle: 1.40mm  
 Lineweight of open circle: 0.15mm  
 Length of stem or segment: 1.10mm  
 Lineweight (all or other): 0.15mm

Color Token: Black

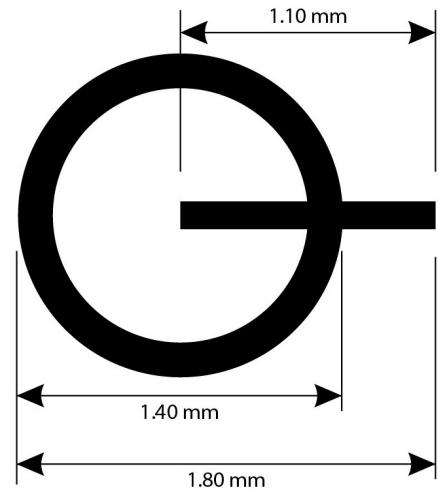

Description: **Culvert "V"**

Component Ref #: P00107

Color Token: Black

Origin: Apex of "V"

Length of stem or segment: 1.00mm  
 Lineweight (all or other): 0.20mm  
 Angle between elements: 90°

Note: Apex is where the lines connect to form a "V".

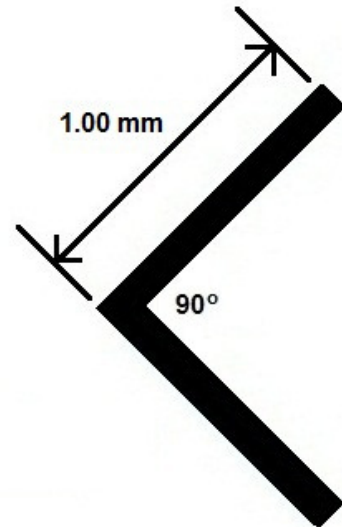

Description: **Culvert double "V"**

Component Ref #: P00106

Color Token: Black

Origin: Center of symbol

Length of stem or segment: 1.00mm  
 Lineweight (all or other): 0.20mm  
 Angle between elements: 90°

Note: Spacing between "V" elements is variable based on the width of the corresponding transportation feature.

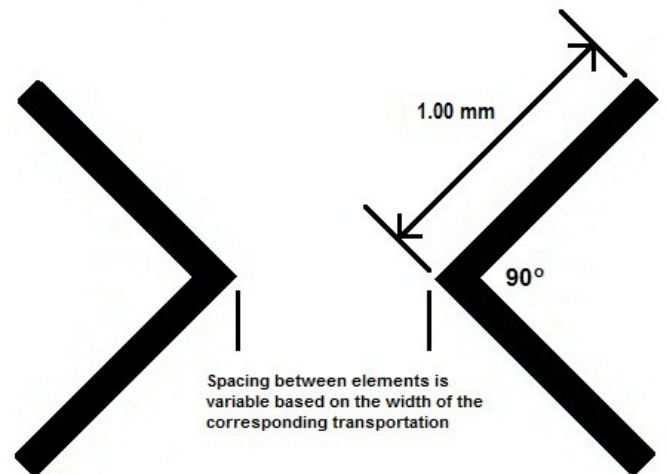

Description: **Dish aerial**

Component Ref #: P00133

Color Token: Black

Origin: Center of open circle

Overall component height: 2.40mm

Overall component width: 1.25mm

Diameter of open circle: 0.60mm

Lineweight of open circle: 0.10mm

Lineweight of stem or base: 0.10mm

Lineweight (all or other): 0.10mm

Grid square size: 0.20mm x 0.20mm

Note: Length of base 1.00mm. Body tapers from 0.35mm to 0.65mm at the base

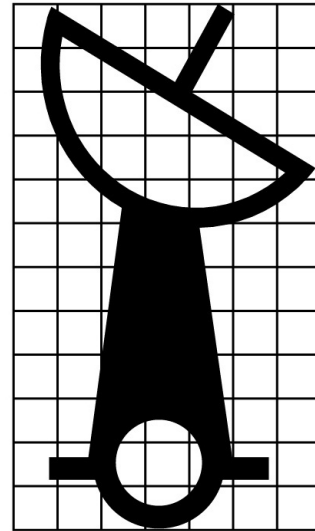

Description: **Extraction mine intact not peat**

Component Ref #: P00001

Color Token: Black

Origin: Center of symbol

Overall component height: 1.85mm

Overall component width: 1.85mm

Lineweight (all or other): 0.25mm

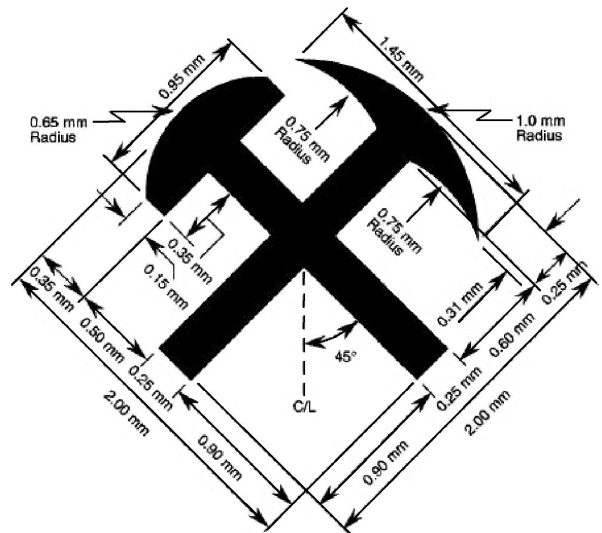

Description: **Extraction mine not intact not peat**

Component Ref #: P00002

Color Token: Black

Origin: Center of symbol

Overall component height: 1.85mm

Overall component width: 1.85mm

Lineweight (all or other): 0.25mm



Description: **Extraction mine peat**

Component Ref #: P00084 Color Token: Black

Origin: Center of symbol

Overall component height: 2.00mm

Overall component width: 4.50mm

Lineweight (all or other): 0.10mm

Note: Each rectangle 1.50mm x 1.00mm

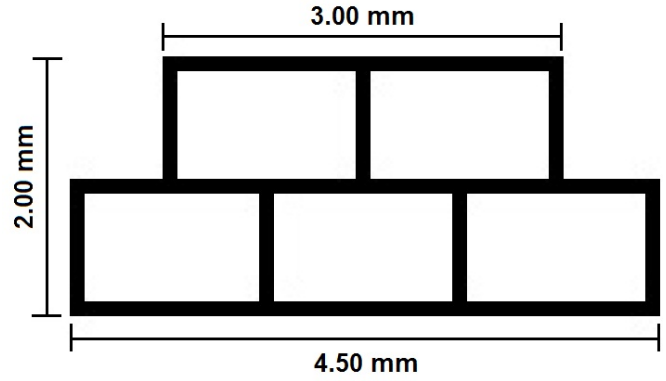

Description: **Fence "X"**

Component Ref #: P00286 Color Token: Black

Origin: Center of symbol

Overall component height: 1.00mm

Overall component width: 1.00mm

Length of stem or segment: 1.00mm

Lineweight (all or other): 0.15mm

Angle between elements: 90°

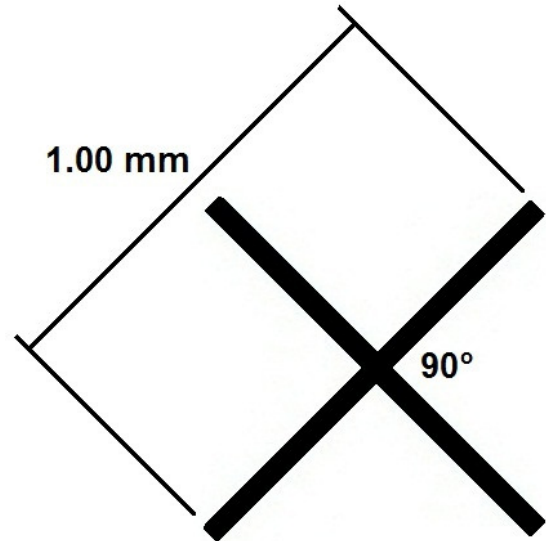

Description: **Flare pipe**

Component Ref #: P00145 Color Token: Black

Origin: Center of open circle

Overall component height: 2.60mm

Overall component width: 1.00mm

Diameter of open circle: 0.60mm

Lineweight of open circle: 0.10mm

Lineweight of stem or base: 0.10mm

Grid square size: 0.10mm x 0.10mm

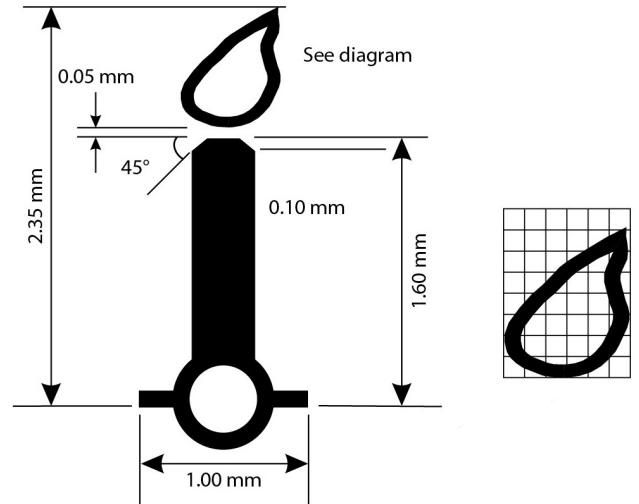

Description: **Fortified building**

Component Ref #: P00108

Color Token: Black

Origin: Center of symbol

Overall component height: 1.50mm

Overall component width: 1.50mm

Length of stem or segment: 0.50mm

Lineweight (all or other): 0.10mm

Note: Open square 0.80mm each side.

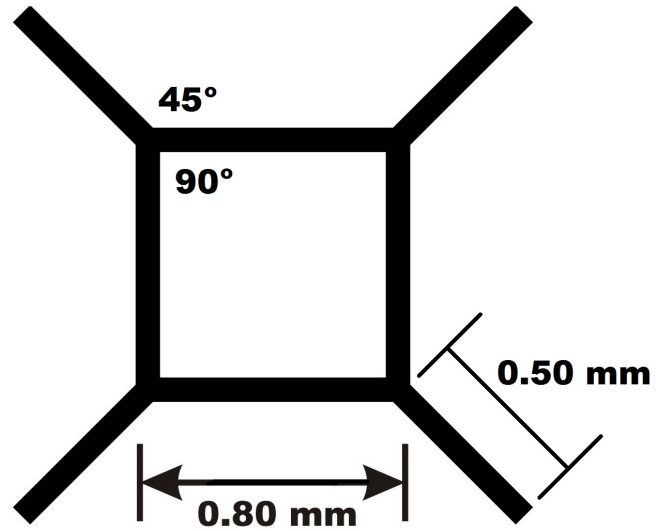

Description: **Geothermal outlet**

Component Ref #: P00027

Color Token: Dk-Brown1815

Origin: Center of solid circle

Overall component height: 2.70mm

Overall component width: 0.80mm

Lineweight (all or other): 0.20mm

Grid square size: 0.20mm x 0.20mm

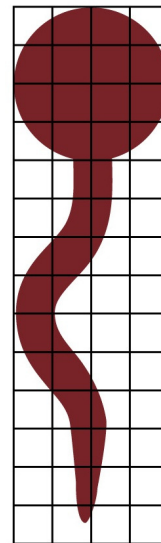

Description: **Greenhouse**

Component Ref #: P00171

Color Token: Black/Green362-42

Origin: Center of symbol

Overall component height: 0.60mm

Overall component width: 0.60mm

Lineweight (all or other): 0.10mm

Note: Outline is Black. Fill is Green362-42 (42% screen, 45° angle)

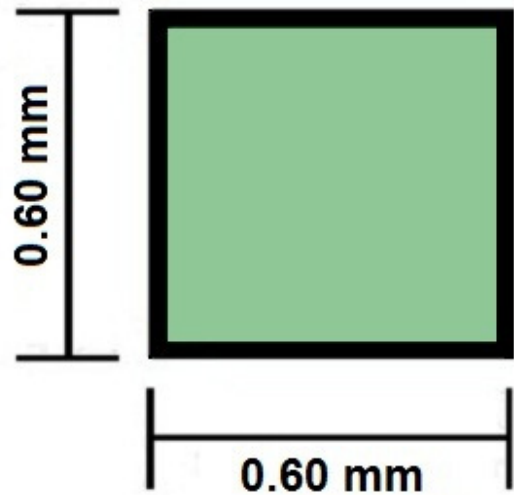

Description: **Hazardous rock/reef**

Component Ref #: P00095

Color Token: Black

Origin: Center of symbol

Overall component height: 1.50mm  
 Overall component width: 1.50mm  
 Length of stem or segment: 1.50mm  
 Lineweight (all or other): 0.10mm  
 Angle between elements: 60°

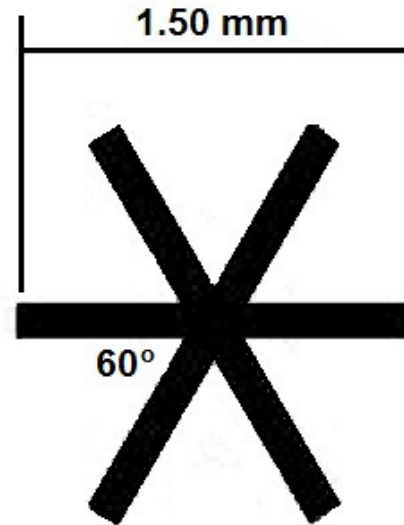

Description: **Helipad**

Component Ref #: P00090

Color Token: Blue072

Origin: Center of symbol

Overall component height: 3.00mm  
 Overall component width: 3.00mm  
 Diameter of open circle: 3.00mm  
 Lineweight (all or other): 0.25mm

Note: The "H" is formed by two 1.50mm vertical lines and one 1.20mm horizontal line.



Description: **Helipad at hospital**

Component Ref #: P00089

Color Token: Blue072

Origin: Center of symbol

Overall component height: 3.00mm  
 Overall component width: 3.00mm  
 Lineweight (all or other): 0.25mm

Note: The "H" is formed by two 1.50mm vertical lines and one 1.20mm horizontal line.





Description: **Ice peak not frozen water**

Component Ref #: P00066

Color Token: Dk-Brown1815

Origin: Center of symbol

Overall component height: 2.70mm

Overall component width: 2.70mm

Length of stem or segment: 0.60mm

Lineweight (all or other): 0.15mm

Angle between elements: 45°

Note: Ticks emanate from a 1.50mm circle

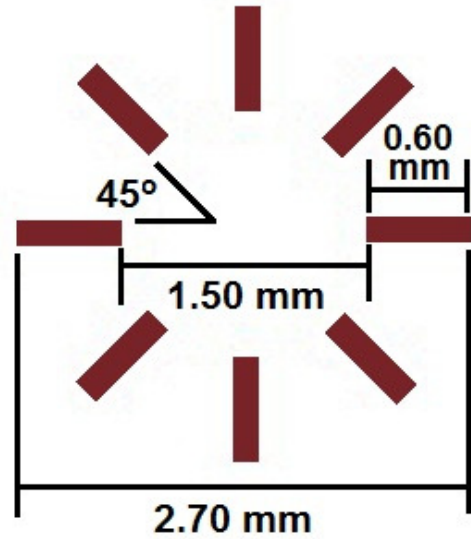

Description: **Lighthouse**

Component Ref #: P00135

Color Token: Black

Origin: Center of open circle

Overall component height: 3.10mm

Overall component width: 2.65mm

Diameter of open circle: 0.60mm

Lineweight of open circle: 0.10mm

Lineweight of stem or base: 0.10mm

Lineweight of ticks: 0.15mm

Note: Four 0.90mm "rays" rotated 30, 150, 210, and 330 degrees. A white 0.30mm square is placed 0.10mm from top.

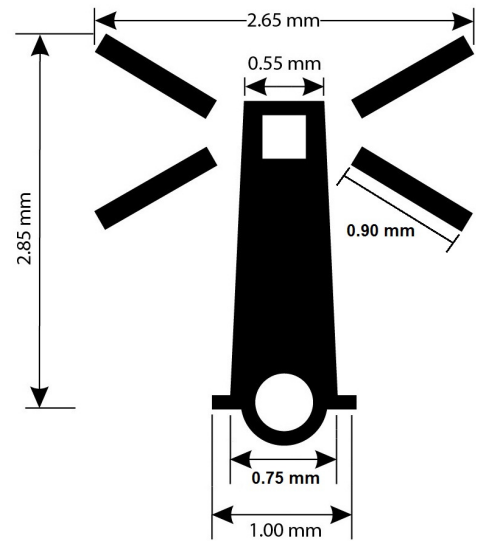

Description: **Located object**

Component Ref #: P00010

Color Token: Black

Origin: Center of symbol

Overall component height: 1.25mm

Overall component width: 1.25mm

Diameter of solid circle: 0.30mm

Diameter of open circle: 1.25mm

Lineweight of open circle: 0.15mm

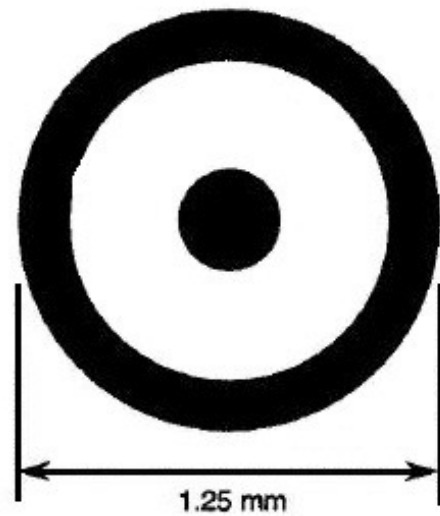

Description: **Lock/pedestrian bridge/sluice gate "V"**

Component Ref #: P00105

Color Token: Black

Origin: Apex of "V"

Length of stem or segment: 0.80mm

Lineweight (all or other): 0.15mm

Angle between elements: 90°

Note: Apex is where the lines connect to form a "V".

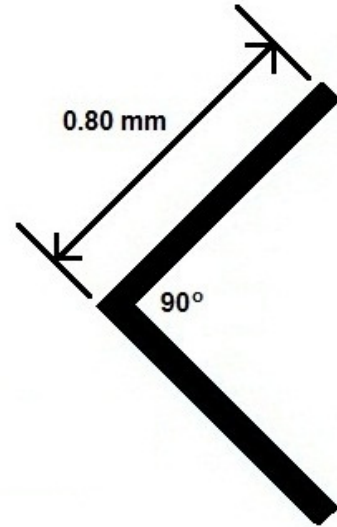

Description: **Memorial monument**

Component Ref #: P00136

Color Token: Black

Origin: Center of symbol

Overall component height: 1.50mm

Overall component width: 1.50mm

Diameter of open circle: 1.50mm

Lineweight of open circle: 0.10mm

Note: Equilateral triangle fits within open circle and is 1.20mm on each side

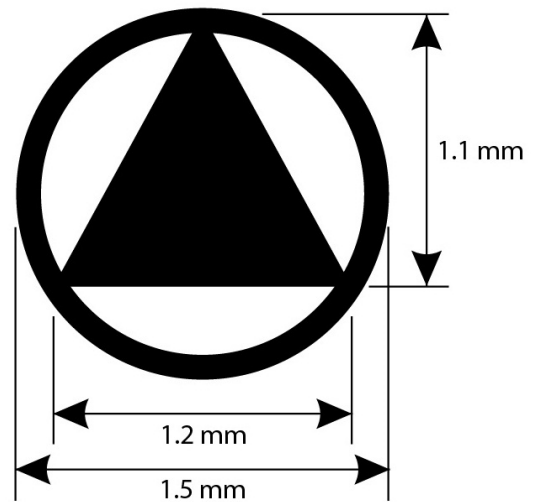

Description: **Mooring mast**

Component Ref #: P00198

Color Token: Black

Origin: Center of open circle

Overall component height: 2.00mm

Overall component width: 1.65mm

Diameter of open circle: 0.60mm

Lineweight of open circle: 0.10mm

Length of stem or segment: 1.40mm

Lineweight of stem or base: 0.10mm

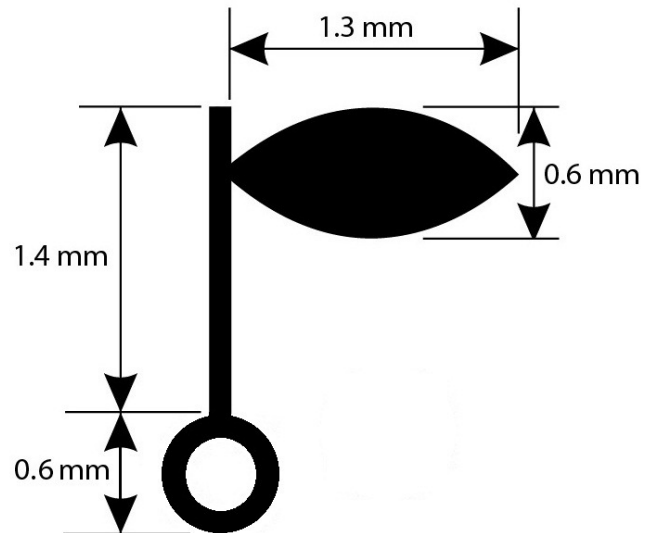

**Description: Motor vehicle station**

Component Ref #: P00165 Color Token: Black

Origin: Center of solid square

Overall component height: 2.10mm

Overall component width: 1.10mm

Length of stem or segment: 0.60mm

Lineweight (all or other): 0.15mm

Angle between elements: 60°

Note: Solid square 0.50mm each side.

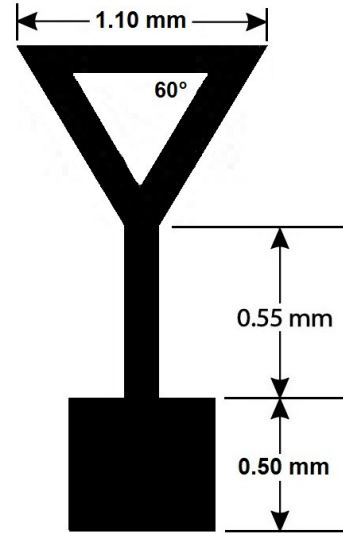

**Description: Motor vehicle station symbol**

Component Ref #: P00275 Color Token: Black

Origin: Center of base of staff

Overall component height: 1.60mm

Overall component width: 1.10mm

Length of stem or segment: 0.60mm

Lineweight (all or other): 0.15mm

Angle between elements: 60°

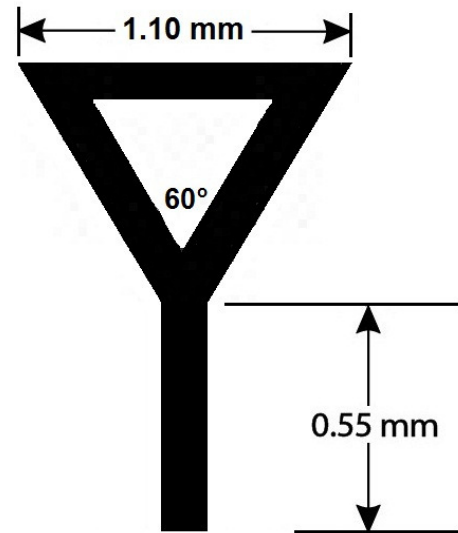

**Description: Mountain pass**

Component Ref #: P00029 Color Token: Black

Origin: Center of symbol

Overall component height: 4.20mm

Overall component width: 2.82mm

Note: Space between inner and outer arc radii forms the symbol. Inner arc radii is 3.50mm. Outer arc radii is 5.00mm.

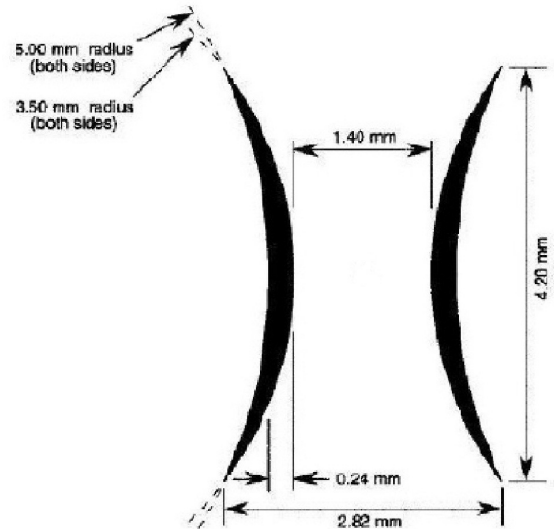

Description: **Natural pool intermittent**

Component Ref #: P00032 Color Token: Cyan

Origin: Center of open circle

Overall component height: 2.90mm  
 Overall component width: 1.00mm  
 Diameter of open circle: 1.00mm  
 Lineweight of open circle: 0.15mm  
 Lineweight (all or other): 0.20mm  
 Grid square size: 0.20mm x 0.20mm

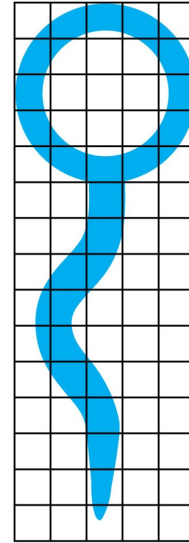

Description: **Natural pool perennial**

Component Ref #: P00026 Color Token: Cyan

Origin: Center of solid circle

Overall component height: 2.70mm  
 Overall component width: 0.80mm  
 Diameter of solid circle: 0.8mm  
 Lineweight (all or other): 0.20mm  
 Grid square size: 0.20mm x 0.20mm

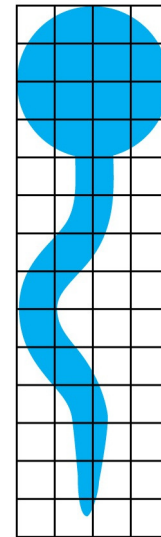

Description: **Not intact circle 0.8mm**

Component Ref #: P00291 Color Token: Black/Black-12

Origin: Center of symbol

Overall component height: 0.80mm  
 Overall component width: 0.80mm  
 Diameter of open circle: 0.80mm  
 Lineweight (all or other): 0.10mm  
 Note: Fill is Black-12 (12% screen 45° angle)

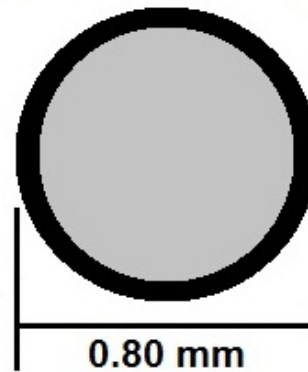

Description: **Not intact square 0.6mm**

Component Ref #: P00293

Color Token: Black/Black-12

Origin: Center of symbol

Overall component height: 0.60mm

Overall component width: 0.60mm

Lineweight (all or other): 0.10mm

Note: Fill is Black-12 (12% screen 45° angle)



---

Description: **Not intact square 0.8mm**

Component Ref #: P00173

Color Token: Black/Black-12

Origin: Center of symbol

Overall component height: 0.80mm

Overall component width: 0.80mm

Lineweight (all or other): 0.10mm

Note: Fill is Black-12 (12% screen 45° angle)



---

Description: **Oasis**

Component Ref #: P00260

Color Token: Green362

Origin: Center of symbol

Overall component height: 3.00mm

Overall component width: 2.70mm

Lineweight of stem or base: 0.20mm

Grid square size: 0.20mm x 0.20mm

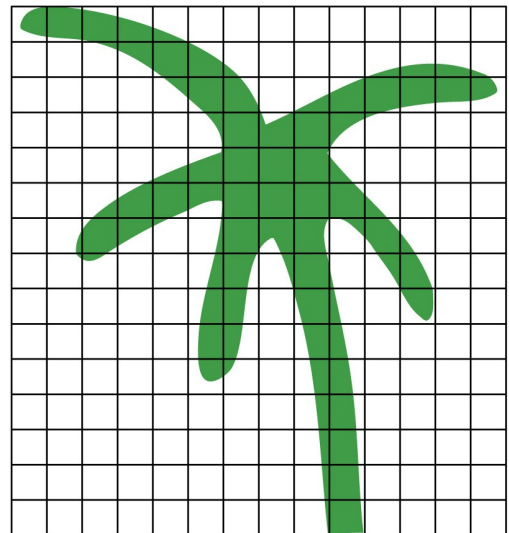

Description: **Offshore construction point**

Component Ref #: P00163 Color Token: Black

Origin: Center of symbol

Overall component height: 1.20mm  
 Overall component width: 1.20mm  
 Diameter of solid circle: 0.20mm  
 Lineweight (all or other): 0.10mm

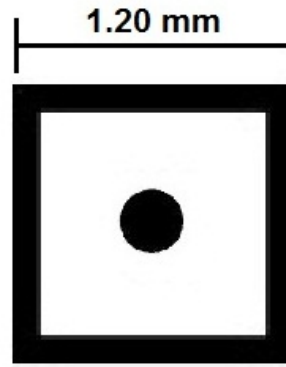

Description: **Pipeline elevated "V"**

Component Ref #: P00045 Color Token: Black

Origin: Apex of "V"

Length of stem or segment: 0.70mm  
 Lineweight (all or other): 0.20mm  
 Angle between elements: 90°

Note: Apex is where the lines connect to form a "V".

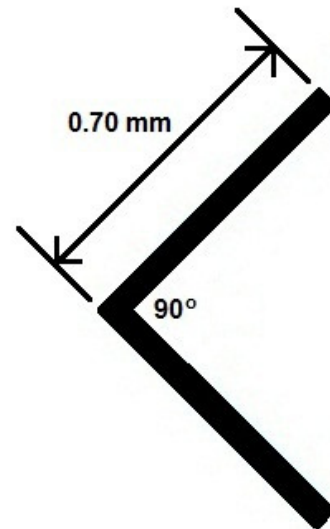

Description: **Pipeline water elevated "V"**

Component Ref #: P00058 Color Token: Cyan

Origin: Apex of "V"

Length of stem or segment: 0.70mm  
 Lineweight (all or other): 0.20mm  
 Angle between elements: 90°

Note: Apex is where the lines connect to form a "V".

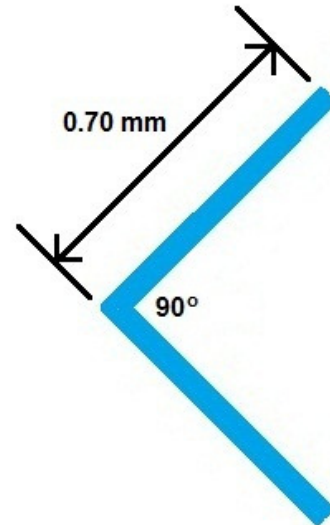

Description: **Power substation**

Component Ref #: P00138

Color Token: Black/Blue072-42

Origin: Center of symbol

Overall component height: 2.50mm

Overall component width: 1.00mm

Lineweight (all or other): 0.15mm

Angle between elements: 60°

Note: Outline is Black. Fill is Blue072-42 (42% screen 45° angle).

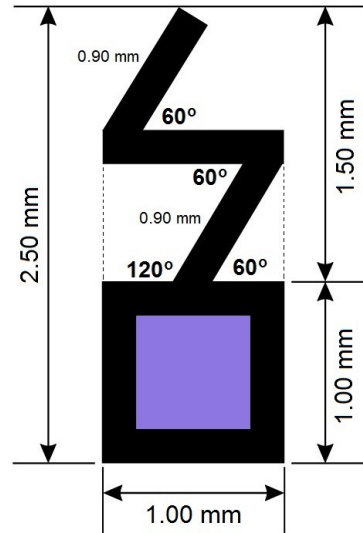

Description: **Pylon**

Component Ref #: P00020

Color Token: Blue072

Origin: Center of symbol

Overall component height: 3.00mm

Overall component width: 1.00mm

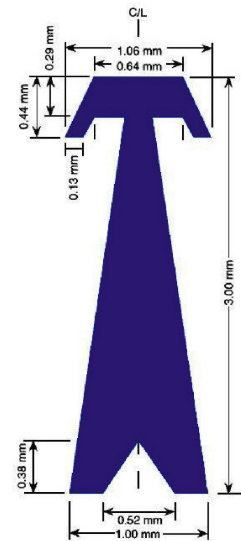

Description: **Radio aid**

Component Ref #: P00294

Color Token: Blue072

Origin: Center of symbol

Overall component height: 1.90mm

Overall component width: 1.90mm

Diameter of solid circle: 0.40mm

Diameter of open circle: 1.90mm

Lineweight of open circle: 0.30mm

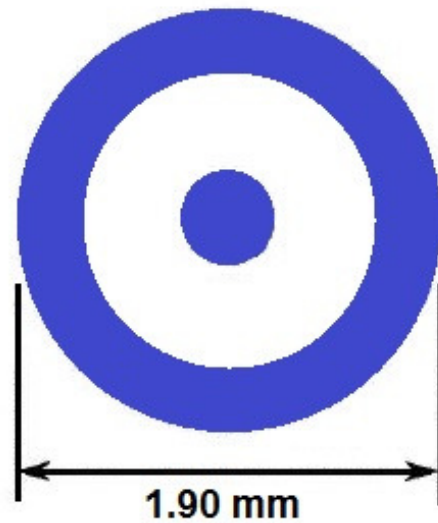

Description: **Railway station**  
 Component Ref #: P00079 Color Token: Black  
 Origin: Center of symbol  
 Overall component height: 1.00mm  
 Overall component width: 1.00mm  
 Lineweight (all or other): 0.10mm  
 Note: Open square 1.00mm each side. Solid square 0.50mm each side.

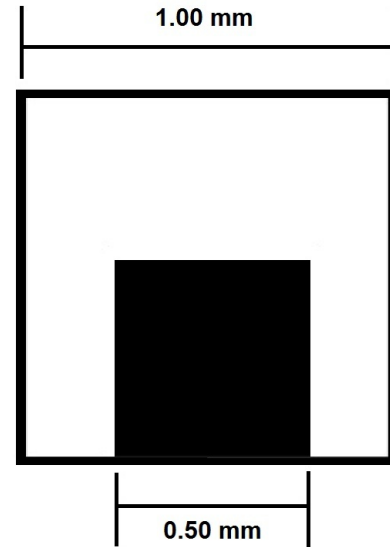

Description: **Railway tick broad double**  
 Component Ref #: P00278 Color Token: Black  
 Origin: Center of symbol  
 Overall component height: 1.50mm  
 Overall component width: 0.80mm  
 Length of stem or segment: 1.50mm  
 Lineweight (all or other): 0.15mm  
 Space between elements: 0.50mm

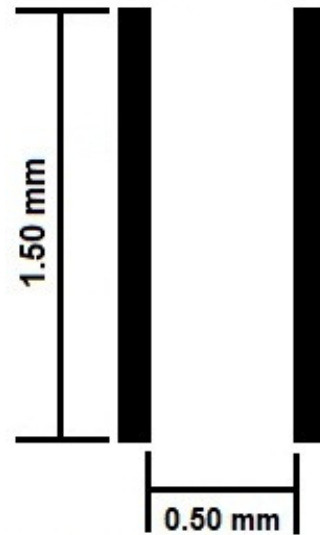

Description: **Railway tick broad electrified**  
 Component Ref #: P00280 Color Token: Black  
 Origin: Center of symbol  
 Overall component height: 1.50mm  
 Overall component width: 0.70mm  
 Length of stem or segment: 1.50mm  
 Lineweight (all or other): 0.15mm  
 Angle between elements: 90°  
 Note: Length of top segment 0.70mm

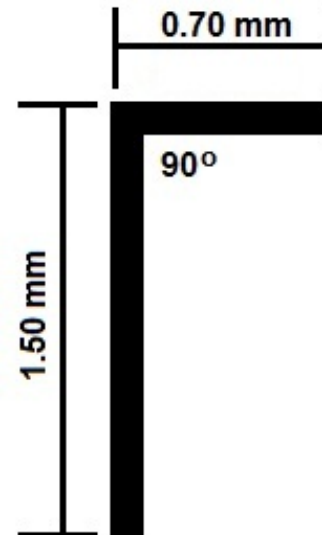



**Description: Railway tick broad electrified double**

Component Ref #: P00282 Color Token: Black

Origin: Center of symbol

Overall component height: 1.50mm

Overall component width: 1.90mm

Length of stem or segment: 1.50mm

Lineweight (all or other): 0.15mm

Angle between elements: 90°

Space between elements: 0.50mm

Note: Length of top segment 0.70mm

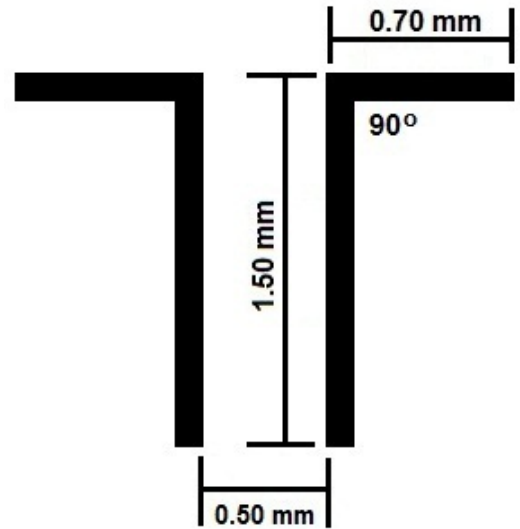

**Description: Railway tick narrow double**

Component Ref #: P00277 Color Token: Black

Origin: Center of symbol

Overall component height: 0.75mm

Overall component width: 0.80mm

Length of stem or segment: 0.75mm

Lineweight (all or other): 0.15mm

Space between elements: 0.50mm

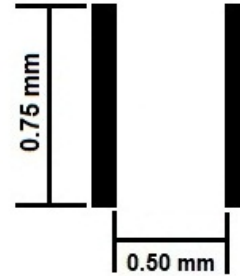

**Description: Railway tick narrow electrified**

Component Ref #: P00279 Color Token: Black

Origin: Center of symbol

Overall component height: 0.75mm

Overall component width: 0.70mm

Length of stem or segment: 0.75mm

Lineweight (all or other): 0.15mm

Angle between elements: 90°

Note: Length of top segment 0.70mm

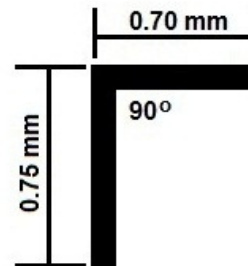

Description: **Railway tick narrow electrified double**

Component Ref #: P00281 Color Token: Black

Origin: Center of symbol

Overall component height: 0.75mm

Overall component width: 1.90mm

Length of stem or segment: 0.75mm

Lineweight (all or other): 0.15mm

Angle between elements: 90°

Space between elements: 0.50mm

Note: Length of top segment 0.70mm

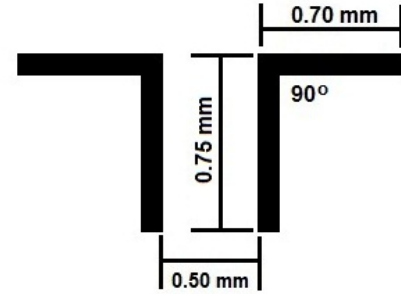

Description: **Railway turntable**

Component Ref #: P00238 Color Token: Black

Origin: Center of symbol

Overall component height: 1.50mm

Overall component width: 1.50mm

Diameter of open circle: 1.50mm

Lineweight of open circle: 0.15mm

Lineweight (all or other): 0.15mm

Note: Interior line orientation is 45° centered inside the circle

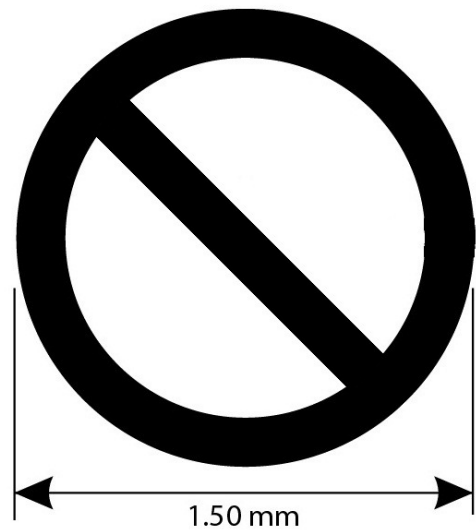

Description: **Rapids**

Component Ref #: P00195 Color Token: Cyan

Origin: Center of symbol

Overall component height: 0.90mm

Overall component width: 1.30mm

Length of stem or segment: 1.30mm

Lineweight (all or other): 0.20mm

Space between elements: 0.50mm

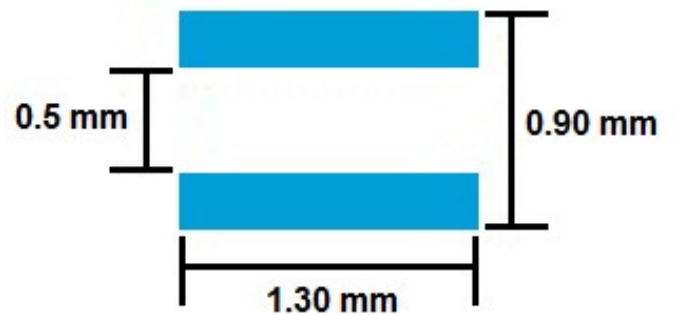

Description: **Reef arc**

Component Ref #: P00207

Color Token: Black-54

Origin: Center of symbol

Overall component height: 0.75mm

Overall component width: 0.70mm

Lineweight (all or other): 0.10mm

Angle between elements: 11°

Note: Arc radius 0.20mm. Symbol is Black-54 (54% screen 45° angle).

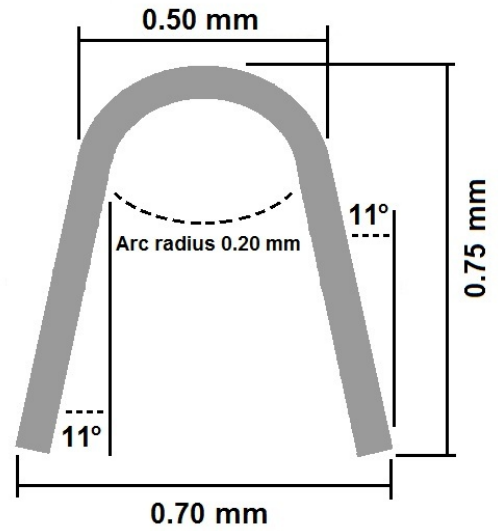

Description: **Rig inland**

Component Ref #: P00162

Color Token: Black

Origin: Center of open circle

Overall component height: 2.30mm

Overall component width: 1.60mm

Diameter of open circle: 0.60mm

Lineweight of open circle: 0.10mm

Grid square size: 0.20mm x 0.20mm

Note: Base leg end radius is 1.125mm. Tip radius is 0.25mm.

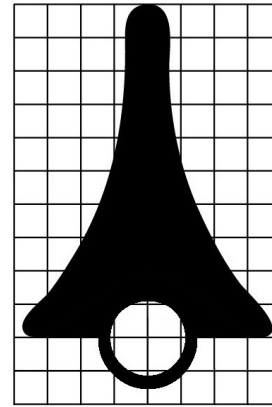

Description: **River flow arrow**

Component Ref #: P00200

Color Token: Cyan

Origin: Center of symbol

Overall component height: 1.50mm

Overall component width: 9.00mm

Lineweight (all or other): 0.25mm

Grid square size: 0.20mm x 0.20mm

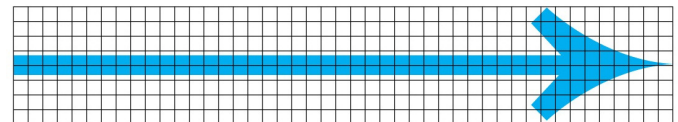

Description: **Road route marker national non-USA**

Component Ref #: P00268 Color Token: Black

Origin: Center of symbol

Overall component height: 2.25mm

Overall component width: 4.50mm

Lineweight (all or other): 0.10mm

Note: Arc radius 0.70mm

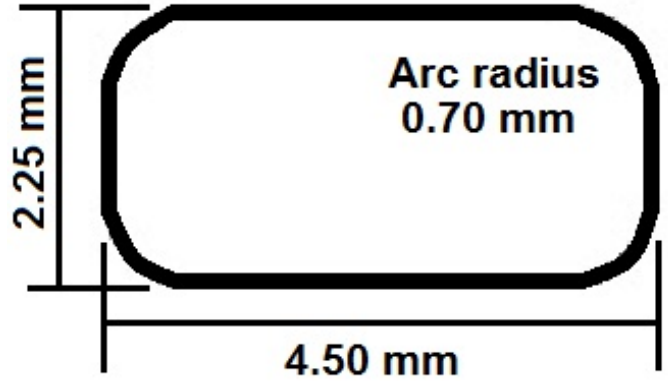

Description: **Rock formation**

Component Ref #: P00071 Color Token: Dk-Brown1815

Origin: Center of symbol

Overall component height: 1.44mm

Overall component width: 1.44mm

Diameter of open circle: 0.25mm

Length of stem or segment: 0.60mm

Lineweight (all or other): 0.25mm

Angle between elements: 60°

Note: Ticks emanate from a 0.25mm circle

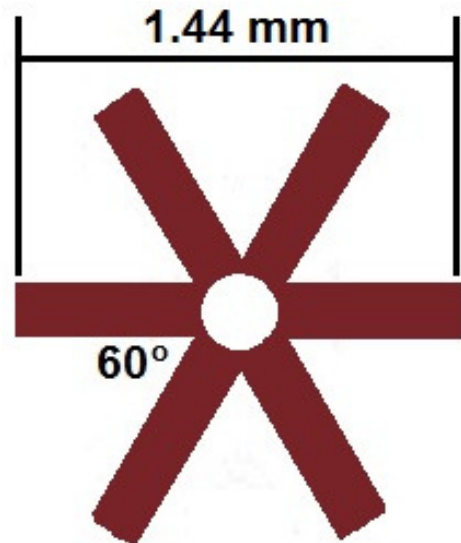

Description: **Ruins**

Component Ref #: P00265 Color Token: Black

Origin: Center of symbol

Overall component height: 1.20mm

Overall component width: 1.20mm

Diameter of solid circle: 0.40mm

Angle between elements: 60°

Space between elements: 0.40mm

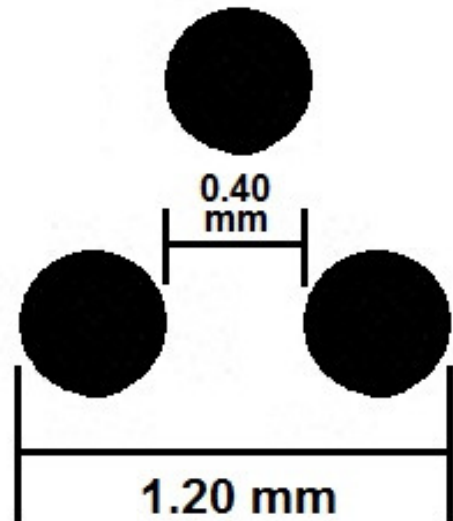

Description: **Settling pond**

Component Ref #: P00288

Color Token: Black/Cyan-31

Origin: Center of symbol

Overall component height: 0.80mm

Overall component width: 0.80mm

Lineweight (all or other): 0.10mm

Note: Outline is Black. Fill is Cyan-31 (31% screen 45° angle)

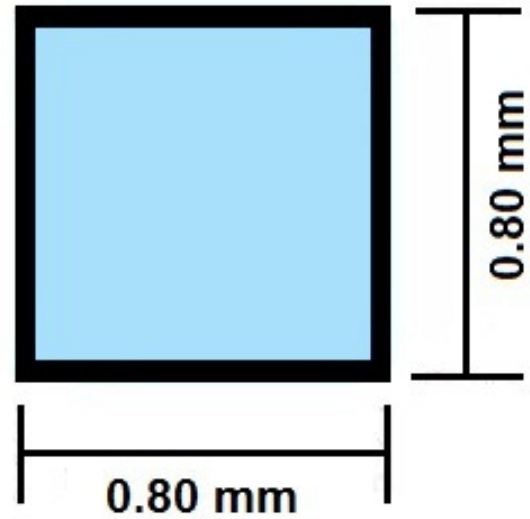

Description: **Ski jump**

Component Ref #: P00274

Color Token: Black

Origin: Center of symbol

Overall component height: 2.00mm

Overall component width: 2.50mm

Lineweight (all or other): 0.20mm

Grid square size: 0.20mm x 0.20mm

Note: Width of top 0.40mm. Width of bottom of thick base 1.00mm. Height of thick base to apex of ramp 1.50mm. Angle between ramp and thick base is 25 degrees.

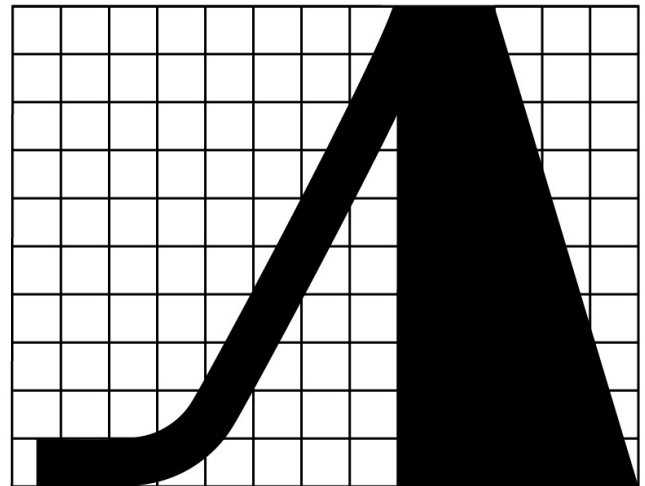

Description: **Smokestack**

Component Ref #: P00140

Color Token: Black

Origin: Center of open circle

Overall component height: 2.50mm

Overall component width: 1.25mm

Diameter of open circle: 0.60mm

Lineweight of open circle: 0.10mm

Lineweight of stem or base: 0.10mm

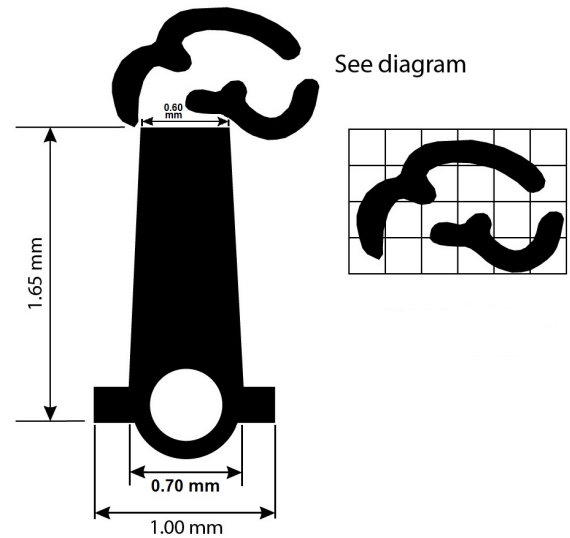

**Description: Sports ground**

Component Ref #: P00210

Color Token: Green362/Green362-12

Origin: Center of symbol

Overall component height: 1.50mm

Overall component width: 1.50mm

Lineweight (all or other): 0.15mm

Note: Fill is Green362-12 (12% screen 45° angle). Green, 6 pt. condensed, upper case "S" is centered within square.

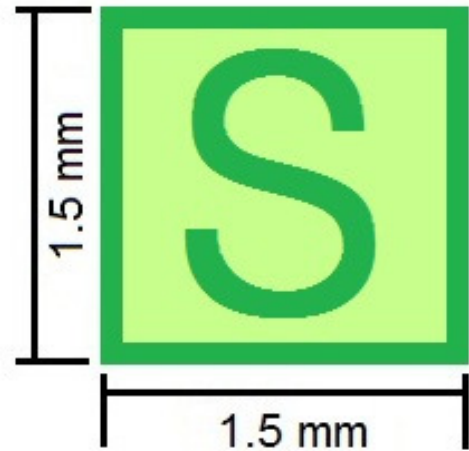

**Description: Surface bunker**

Component Ref #: P00283

Color Token: Black/Dk-Brown1815

Origin: Center of symbol

Overall component height: 1.50mm

Overall component width: 2.20mm

Lineweight of ticks: 0.15mm

Lineweight (all or other): 0.10mm

Note: Tick spacing (intersecting the ellipse) is 0.35mm. Angle of sides 65 and 115 degrees. Base is Black. Rays are Dk-Brown1815.

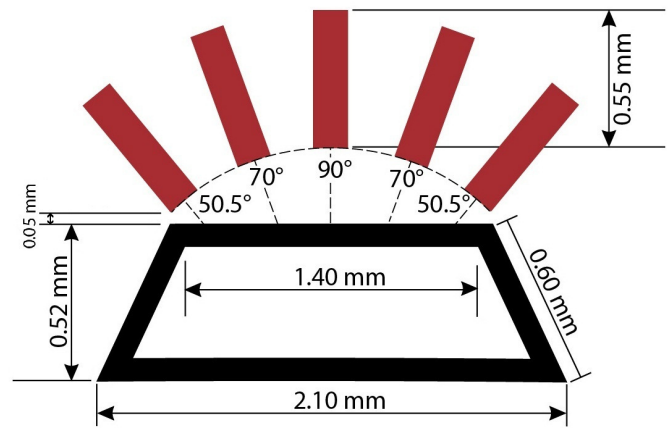

**Description: Survey point geodetic**

Component Ref #: P00179

Color Token: Black

Origin: Center of symbol

Overall component height: 1.30mm

Overall component width: 1.50mm

Diameter of solid circle: 0.30mm

Length of stem or segment: 1.50mm

Lineweight (all or other): 0.10mm

Angle between elements: 60°

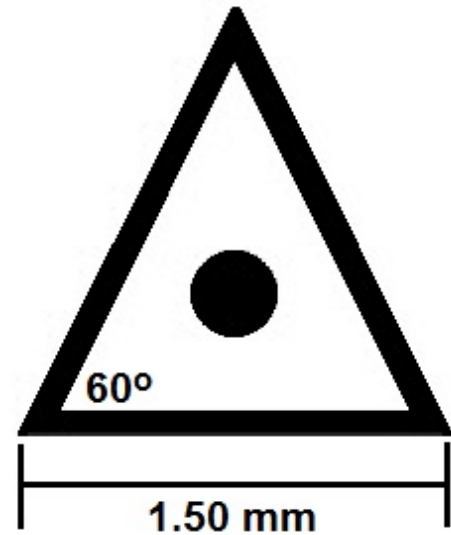

Description: **Swimming pool**

Component Ref #: P00088

Color Token: Black/Cyan-31

Origin: Center of symbol

Overall component height: 0.50mm

Overall component width: 1.00mm

Lineweight (all or other): 0.10mm

Note: Outline is Black. Fill is Cyan-31 (31% screen 45° angle)

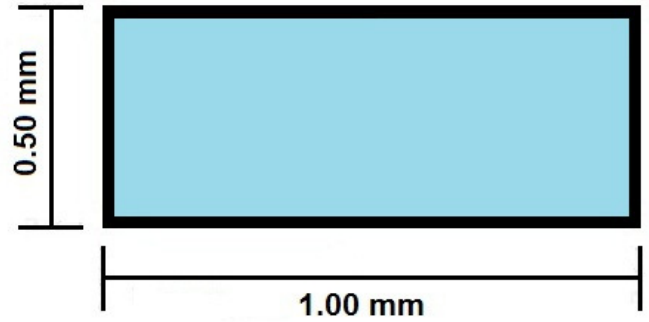

Description: **Tower non-communication**

Component Ref #: P00141

Color Token: Black

Origin: Center of open circle

Overall component height: 2.75mm

Overall component width: 1.00mm

Diameter of open circle: 0.60mm

Lineweight of open circle: 0.10mm

Lineweight of stem or base: 0.10mm

Lineweight (all or other): 0.15mm

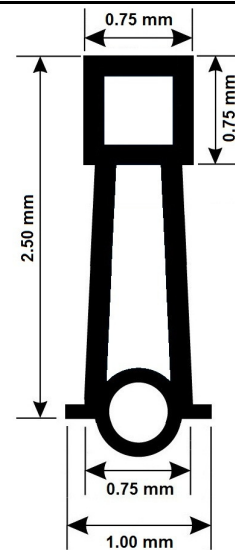

Description: **Tree other**

Component Ref #: P00030

Color Token: Green362

Origin: Center of symbol

Overall component height: 2.50mm

Overall component width: 1.65mm

Lineweight (all or other): 0.20mm

Grid square size: 0.20mm x 0.20mm

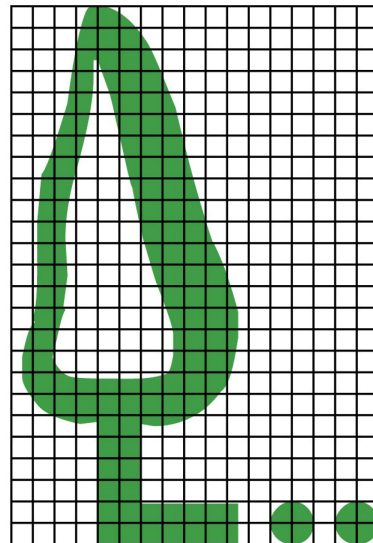

Description: **Tunnel entrance not water**

Component Ref #: P00073 Color Token: Black

Origin: Center of symbol

Overall component height: 2.85mm

Overall component width: 0.65mm

Length of stem or segment: 2.00mm

Lineweight (all or other): 0.20mm

Angle between elements: 45°

Note: Tick length 0.60mm

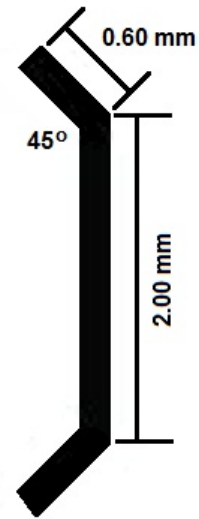

Description: **Vanishing point disappearing**

Component Ref #: P00028 Color Token: Cyan

Origin: Center of symbol

Overall component height: 1.50mm

Overall component width: 1.50mm

Diameter of solid circle: 1.50mm

Diameter of open circle: 0.50mm

Note: Open circle is offset 0.35mm from center of the symbol

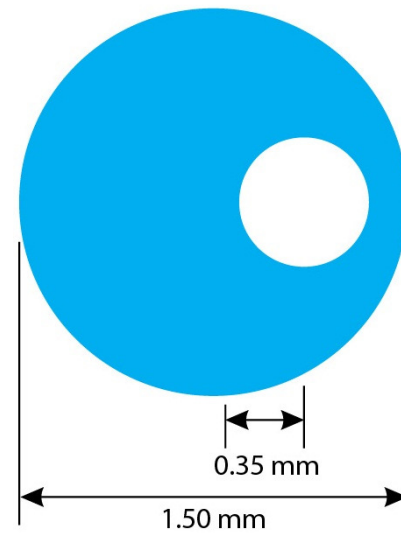

Description: **Vanishing point dissipating**

Component Ref #: P00059 Color Token: Cyan

Origin: Apex of "V"

Length of stem or segment: 1.00mm

Lineweight (all or other): 0.20mm

Angle between elements: 90°

Note: Apex is where the lines connect to form a "V".

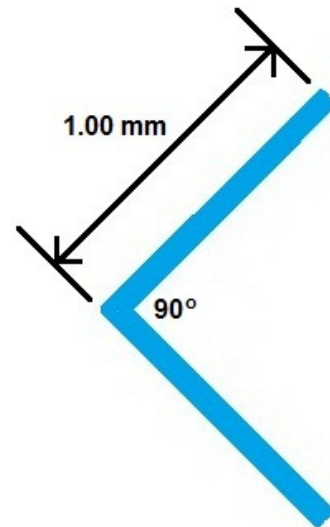



**Description: Vertical obstruction**

Component Ref #: P00008 Color Token: Blue072

Origin: Center of solid circle

Overall component height: 3.70mm

Overall component width: 2.85mm

Diameter of solid circle: 0.40mm

Note: Base leg end radius is 1.125mm. Tip radius is 0.25mm.

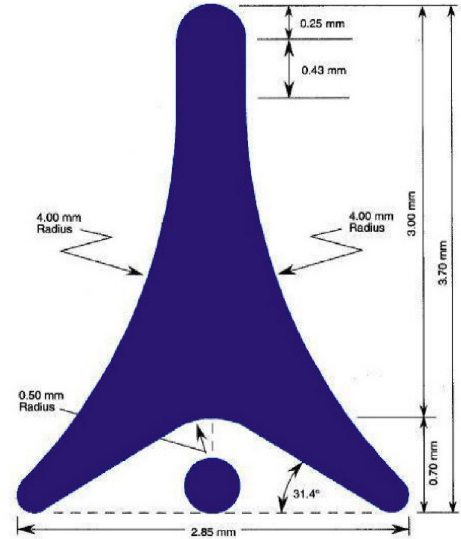

**Description: Vertical obstruction linear**

Component Ref #: P00113 Color Token: Blue072

Origin: Center of open circle

Overall component height: 4.00mm

Overall component width: 4.16mm

Diameter of open circle: 0.60mm

Lineweight of open circle: 0.10mm

Lineweight (all or other): 0.20mm

Grid square size: 0.20mm x 0.20mm

Note: Base leg end radius is 1.125mm. Tip radius is 0.25mm.

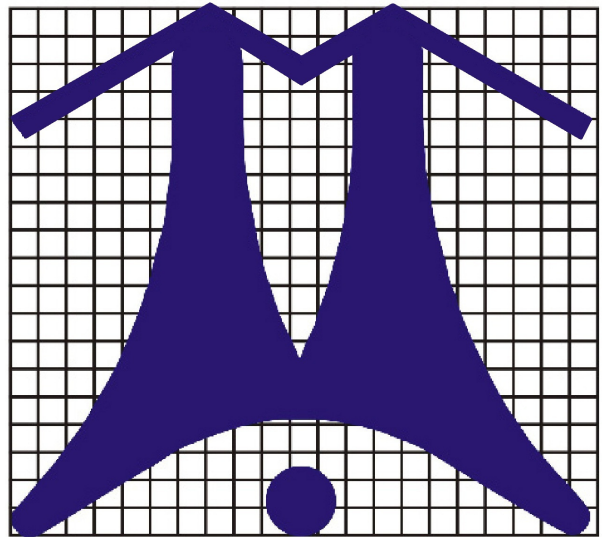

**Description: Vertical obstruction multiple**

Component Ref #: P00101 Color Token: Blue072

Origin: Center of solid circle

Overall component height: 3.70mm

Overall component width: 4.16mm

Diameter of solid circle: 0.50mm

Grid square size: 0.20mm x 0.20mm

Note: Base leg end radius is 1.125mm. Tip radius is 0.25mm. Bottom arc radius is 1.85mm

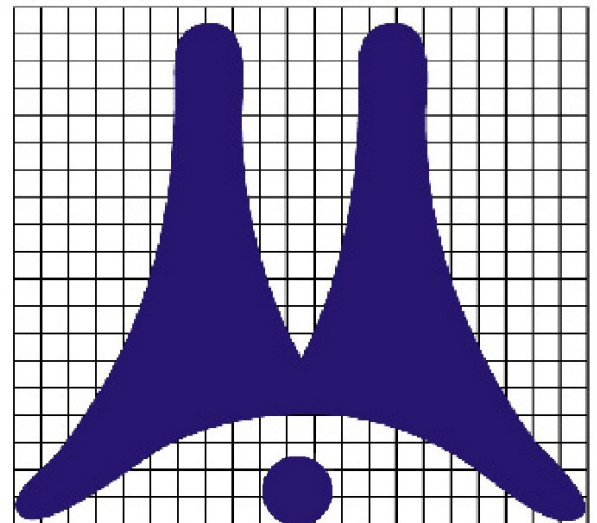

Description: **Vertical obstruction pylon**

Component Ref #: P00292 Color Token: Blue072

Origin: Center of open circle

Overall component height: 4.00mm

Overall component width: 2.85mm

Diameter of open circle: 0.60mm

Lineweight of open circle: 0.10mm

Note: Base leg end radius is 1.125mm. Tip radius is 0.25mm.

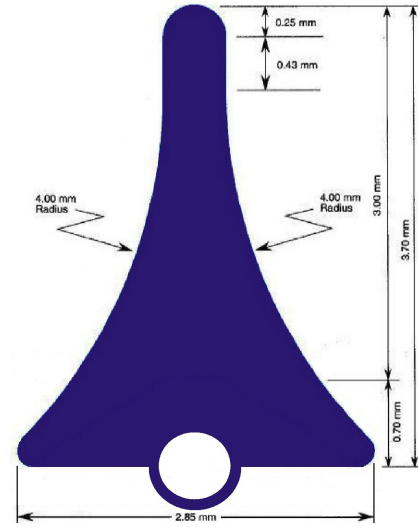

Description: **Volcano**

Component Ref #: P00064 Color Token: Dk-Brown1815

Origin: Center of symbol

Overall component height: 3.0mm

Overall component width: 3.0mm

Diameter of open circle: 1.0mm

Lineweight of open circle: 0.10mm

Length of stem or segment: 1.0mm

Lineweight (all or other): 0.10mm

Angle between elements: 45°

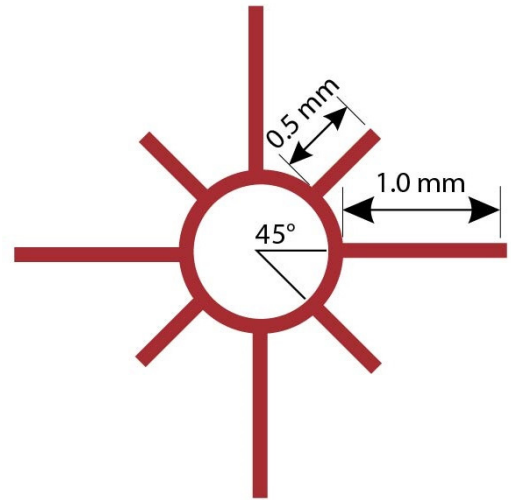

Description: **Water aerodrome**

Component Ref #: P00257 Color Token: Blue072

Origin: Center of symbol

Overall component height: 5.0mm

Overall component width: 5.0mm

Diameter of open circle: 5.0mm

Lineweight of open circle: 0.40mm

Grid square size: 0.20mm x 0.20mm

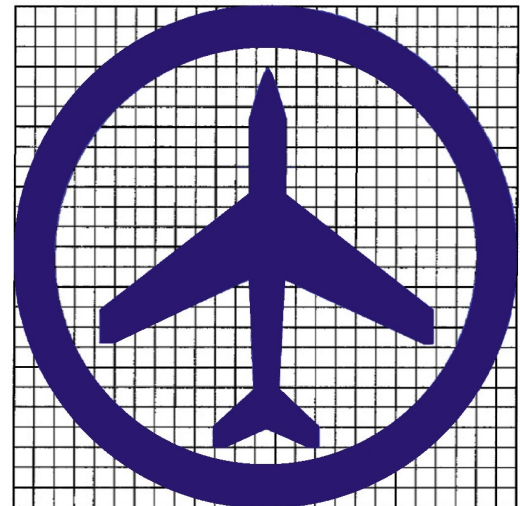

**Description: Water intake tower**

Component Ref #: P00148 Color Token: Black

Origin: Center of solid circle

Overall component height: 2.25mm

Overall component width: 1.25mm

Diameter of open circle: 0.60mm

Lineweight of open circle: 0.10mm

Lineweight of stem or base: 0.10mm

Note: Body tapers from 0.60mm to 0.80mm at the base

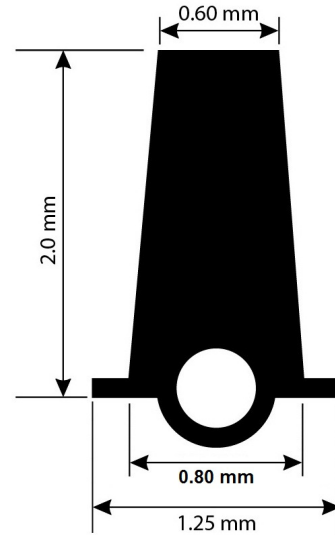

**Description: Water tower**

Component Ref #: P00142 Color Token: Black/Cyan

Origin: Center of open circle

Overall component height: 2.75mm

Overall component width: 1.00mm

Diameter of open circle: 0.60mm

Lineweight of open circle: 0.10mm

Lineweight of stem or base: 0.10mm

Lineweight (all or other): 0.15mm

Note: Outline is black. Fill of circle at top is solid cyan.

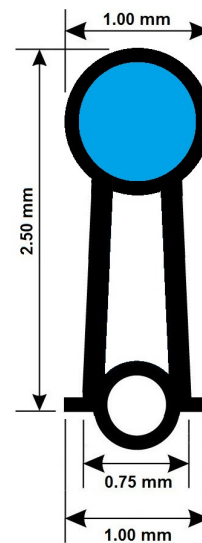

**Description: Wind turbine**

Component Ref #: P00143 Color Token: Black

Origin: Center of open circle

Overall component height: 3.00mm

Overall component width: 1.75mm

Diameter of open circle: 0.60mm

Lineweight of open circle: 0.10mm

Length of stem or segment: 1.40mm

Lineweight of stem or base: 0.10mm

Lineweight (all or other): 0.20mm

Grid square size: 0.20mm x 0.20mm

Note: Length of base 1.00mm. Blades at widest point 0.25mm. Blade length 1.05mm. Angle between blades is 120 degrees

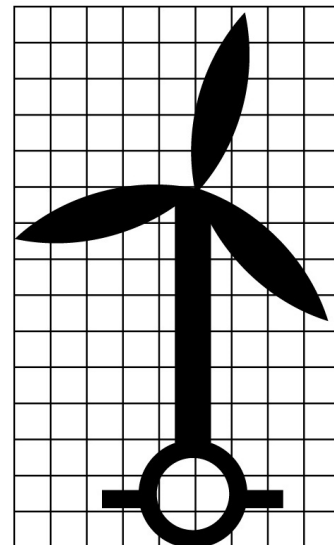

Description: **Windmill**

Component Ref #: P00144

Color Token: Black

Origin: Center of open circle

Overall component height: 2.40mm

Overall component width: 1.20mm

Diameter of open circle: 0.60mm

Lineweight of open circle: 0.10mm

Lineweight of stem or base: 0.10mm

Lineweight (all or other): 0.15mm

Grid square size: 0.20mm x 0.20mm

Note: Length of base 1.20mm. Body is joined at the top and expands to 0.75mm. Vane length is 1.30mm. Acute angle between vanes is 84 degrees; obtuse angle between vanes is 96 degrees.

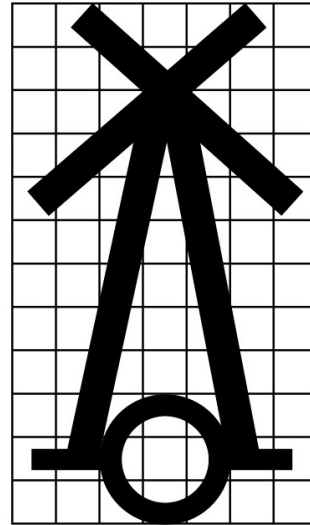

Description: **Wreck**

Component Ref #: P00206

Color Token: Black

Origin: Center of open circle

Overall component height: 1.96mm

Overall component width: 3.41mm

Diameter of open circle: 0.20mm

Lineweight (all or other): 0.20mm

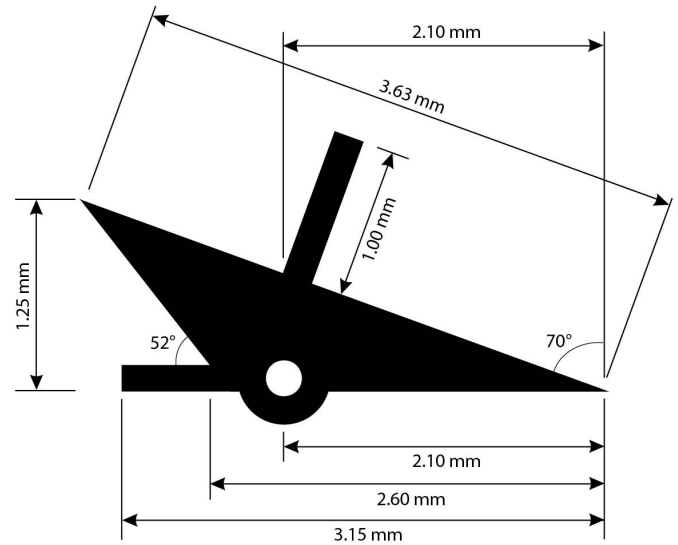

## Annex I – Patterns

Samples of the patterns referenced in Annex A are provided in this annex. The Component Reference number provides the link in Annex A to where the pattern is included as part of a symbol. Since most of the area patterns were inherited from the MIL-STD-2410, a historical reference has been made in the document for each of the patterns in Annex I to identify its original pattern number in the MIL-STD-2410. For example, the field “*MIL-STD-2410 Reference: AP-95*” means that the area pattern was originally AP-95 in the MIL-STD-2410 document. The reader may wish to reference the listed area pattern in the MIL-STD-2410 for additional information.

All pattern samples provided in Annex I are shown in their default orientation (0 degrees). Some area patterns will require rotation to correctly portray the depicted features with ground truth (for example Sand Dunes).

Description: Black Peat Fill

Component Reference: A00001

MIL-STD-2410 Reference: AP-129

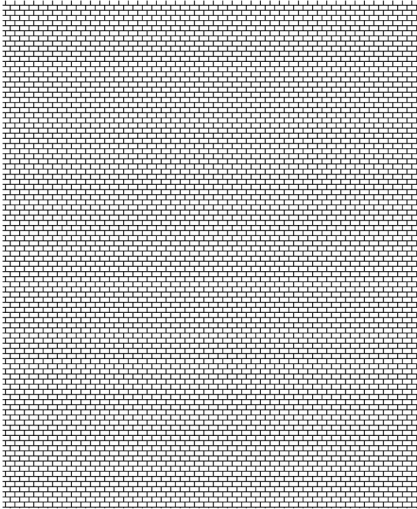

---

Description: Black-42 Shantytown Screened Fill

Component Reference: A00014

MIL-STD-2410 Reference: AP-132

Note: A 42%, 120D, 45 degree angle screen is applied to the area pattern.

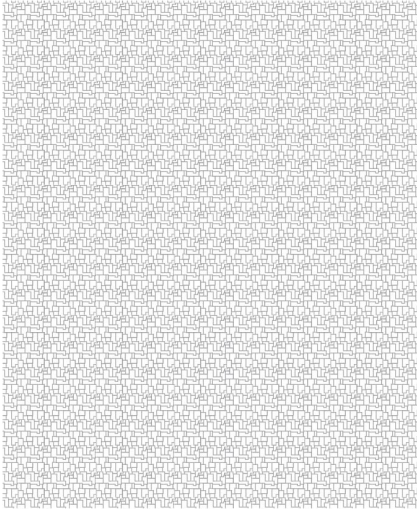

Description: Cyan Bog, Marsh Fill

Component Reference: A00018

MIL-STD-2410 Reference: AP-12

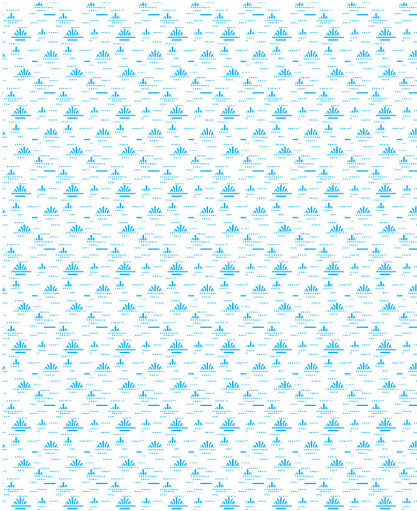

---

Description: Cyan Diagonal Line Fill

Component Reference: A00062

MIL-STD-2410 Reference: LP-3

Note: 35% coverage, 40L, 135 degree angle lines.

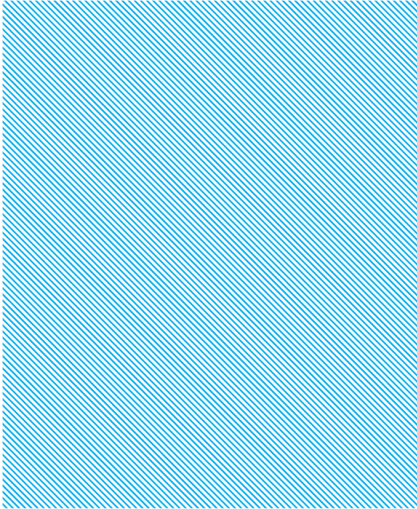

Description: Cyan Dry Drainage Fill

Component Reference: A00020

MIL-STD-2410 Reference: AP-95

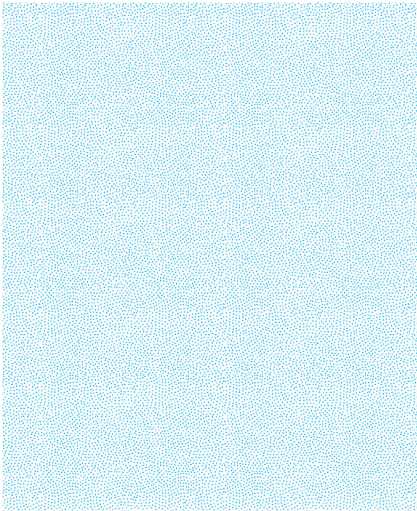

---

Description: Cyan Glacier Fill

Component Reference: A00017

MIL-STD-2410 Reference: AP-104

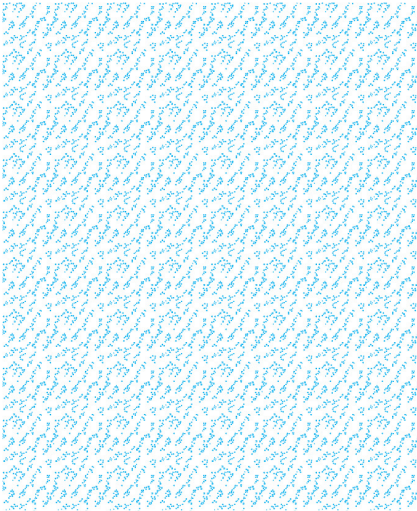



Description: Cyan Land Subject to Inundation Fill

Component Reference: A00015

MIL-STD-2410 Reference: AP-10

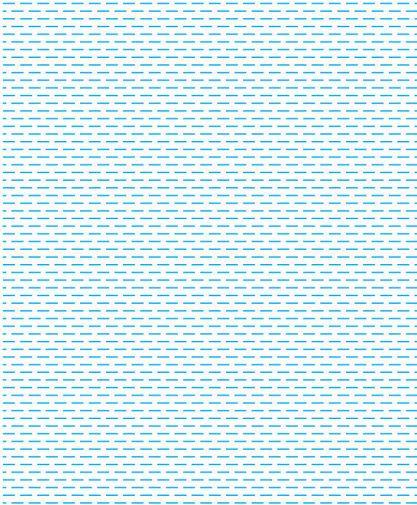

---

Description: Cyan Rapids Pattern

Component Reference: A00065

MIL-STD-2410 Reference: AP-105

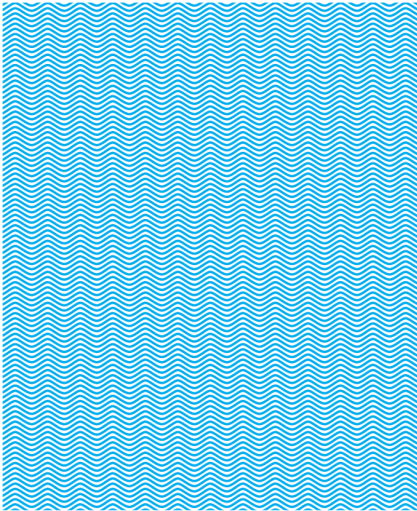

Description: Cyan Rice Fill

Component Reference: A00019

MIL-STD-2410 Reference: AP-4

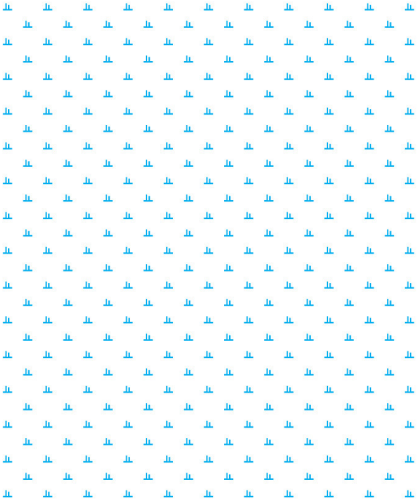

---

Description: Cyan Sabkha Fill

Component Reference: A00016

MIL-STD-2410 Reference: AP-103

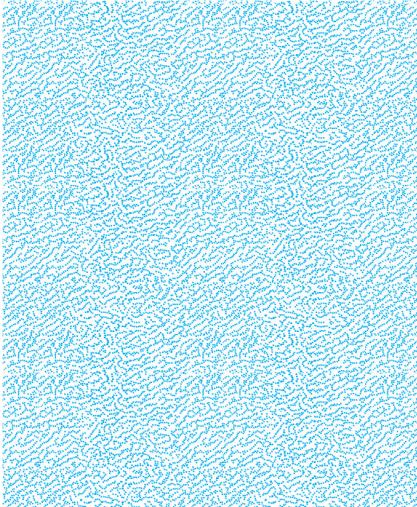

Description: Cyan Salt Evaporator Fill

Component Reference: A00044

MIL-STD-2410 Reference: No existing MIL\_STD\_2410 area pattern.

Note: Specific parameters include - Line weight: 0.2mm; Length: 1.5mm; Grid squares: 1.5mm x 1.5mm. A grid pattern is comprised of 1.5mm x 1.5mm squares. Grid alignment is parallel to longest axis of the perimeter line and centered.

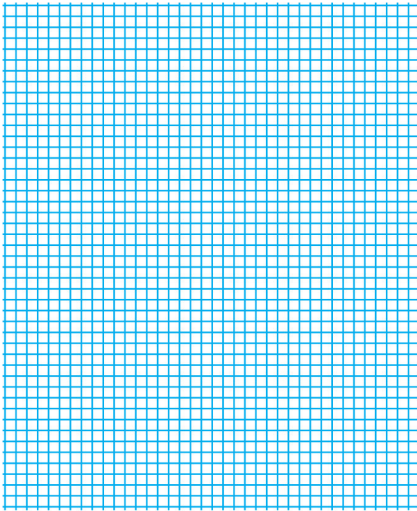

---

Description: Dk-Brown1815 Crescent Sand Dunes Fill

Component Reference: A00031

MIL-STD-2410 Reference: AP-108

Note: Sand Dune Orientation (SDO) value of area pattern symbol sample is 0 degrees. Black arrow indicates prevailing wind direction.

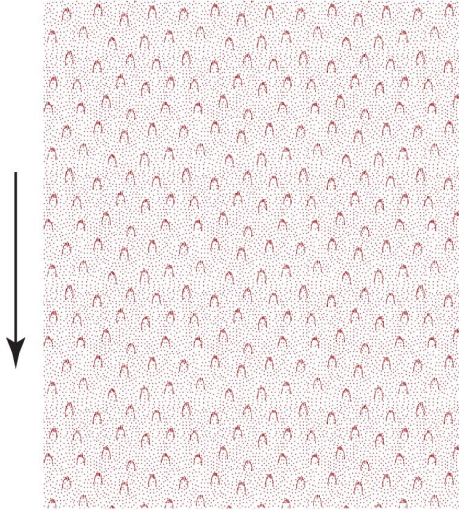

Description: Dk-Brown1815 Diagonal Line Fill

Component Reference: A00061

MIL-STD-2410 Reference: LP-3

Note: 35% coverage, 40L, 135 degree angle lines

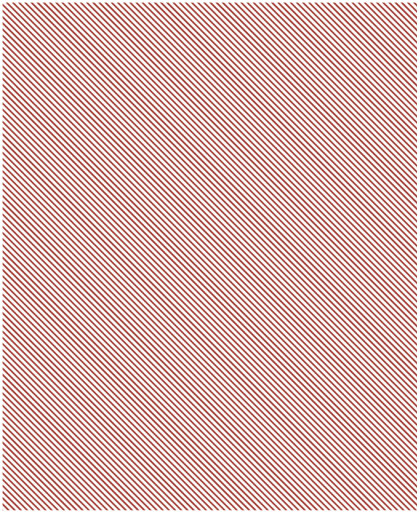

---

Description: Dk-Brown1815 Dome Sand Dunes Fill

Component Reference: A00042

MIL-STD-2410 Reference: AP-126

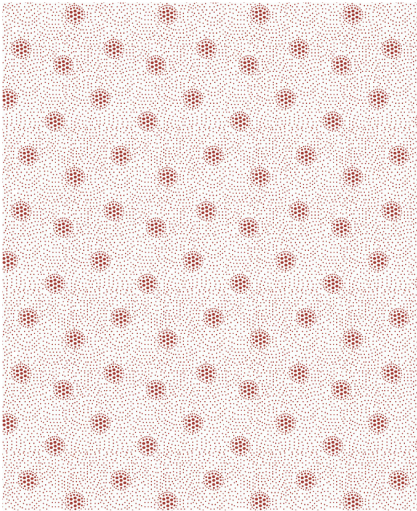

Description: Dk-Brown1815 Gravel Fill

Component Reference: A00036

MIL-STD-2410 Reference: AP-99

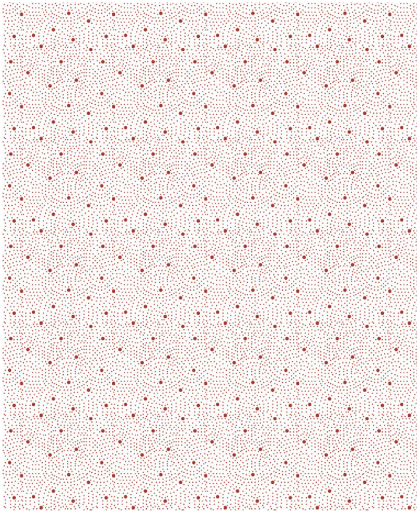

---

Description: Dk-Brown1815 Linear Sand Dunes Fill

Component Reference: A00043

MIL-STD-2410 Reference: AP-118

Note: Sand Dune Orientation (SDO) value of area pattern symbol sample is 0 degrees. Black arrow indicates prevailing wind direction.

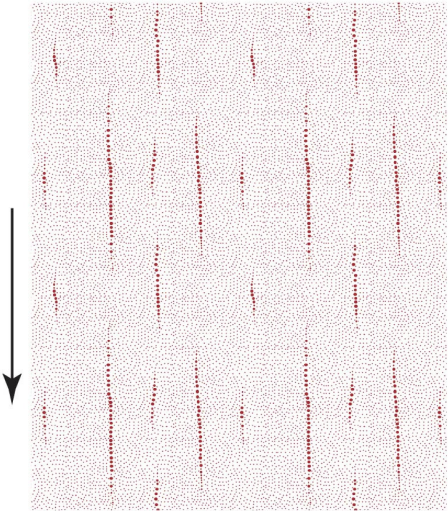

Description: Dk-Brown1815 Ripple Sand Dunes Fill

Component Reference: A00032

MIL-STD-2410 Reference: AP-112

Note: Sand Dune Orientation (SDO) value of area pattern symbol sample is 0 degrees. Black arrow indicates prevailing wind direction.

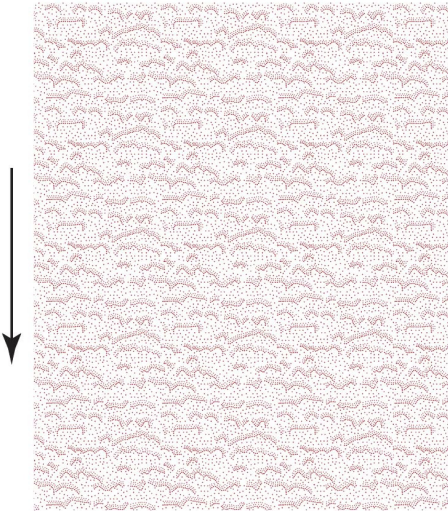

---

Description: Dk-Brown1815 Sand Fill

Component Reference: A00035

MIL-STD-2410 Reference: AP-95

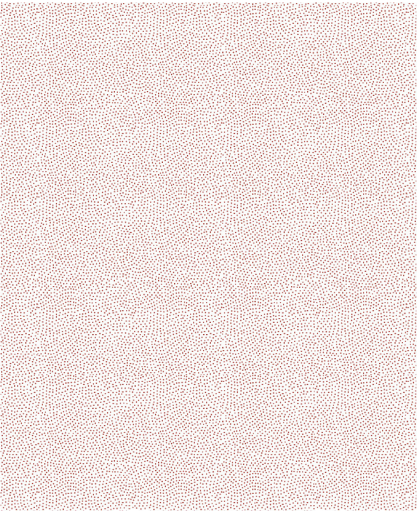

Description: Dk-Brown1815 Star Sand Dunes Fill

Component Reference: A00033

MIL-STD-2410 Reference: AP-120

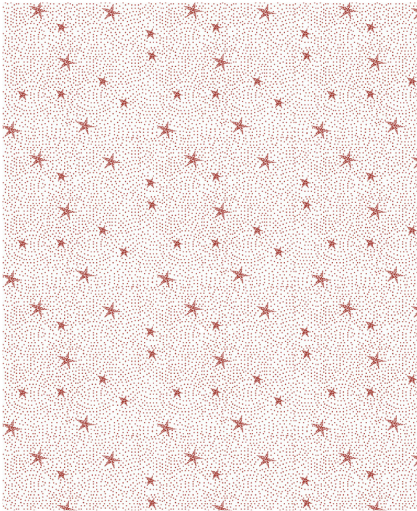

---

Description: Dk-Brown1815 Transverse Sand Dunes Fill

Component Reference: A00034

MIL-STD-2410 Reference: AP-127

Note: Sand Dune Orientation (SDO) value of area pattern symbol sample is 0 degrees. Black arrow indicates prevailing wind direction.

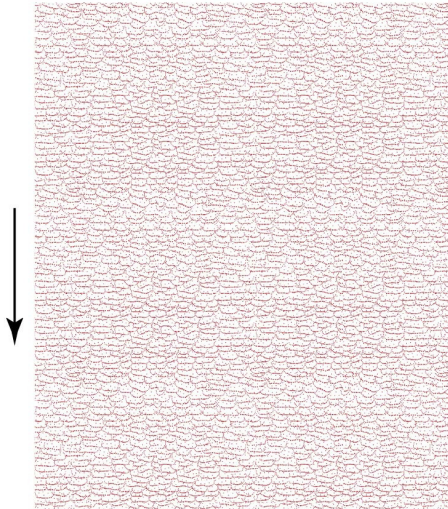

Description: Dk-Brown1815-54 Distorted Surface Screened Fill

Component Reference: A00030

MIL-STD-2410 Reference: AP-103

Note: A 54%, 120D, 45 degree angle screen is applied to the area pattern.

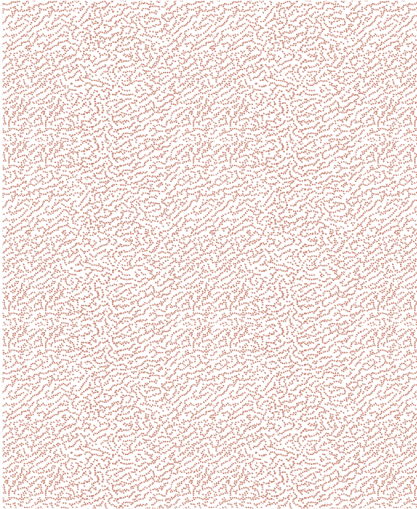

---

Description: Dk-Brown1815-54 Not Intact BUA Screened Fill

Component Reference: A00063

MIL-STD-2410 Reference: LP-6

Note: 38% coverage, 34L, 45/135 degree angle lines and pattern is screened (54% screen, 120D, 45 degree angle)

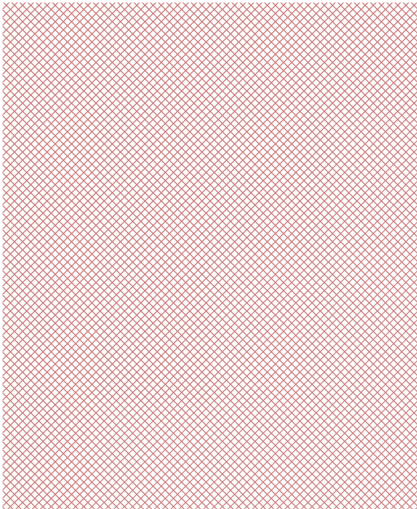



Description: Green362 Cane Fill

Component Reference: A00050

MIL-STD-2410 Reference: AP-86

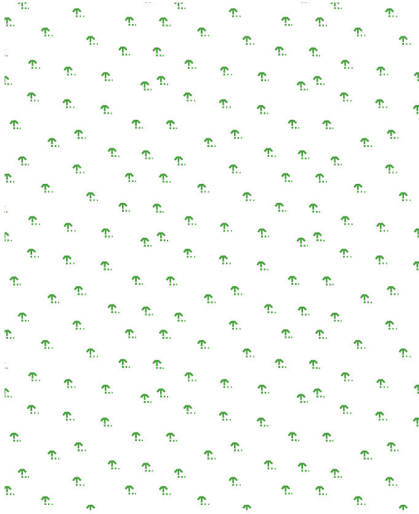

Description: Green362 Cropland dot fill

Component Reference: A00118

MIL-STD-2410 Reference: No existing MIL\_STD\_2410 area pattern.

Note: Green362 0.2mm diameter dots. See diagram for specific parameters. Entire pattern is rotated to 30 degrees.

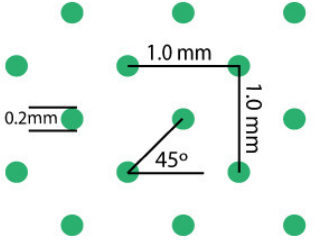
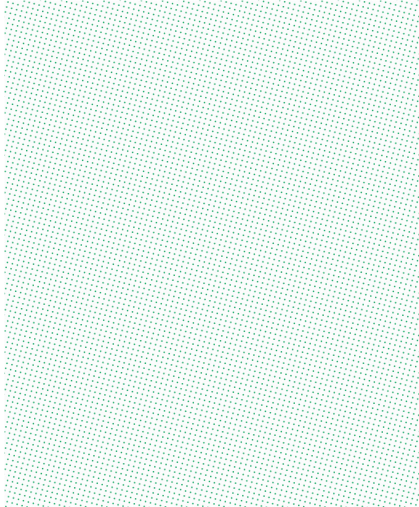

DIAGRAM NOT TO SCALE



Description: Green362 Deciduous Tree Fill

Component Reference: A00011

MIL-STD-2410 Reference: AP-54

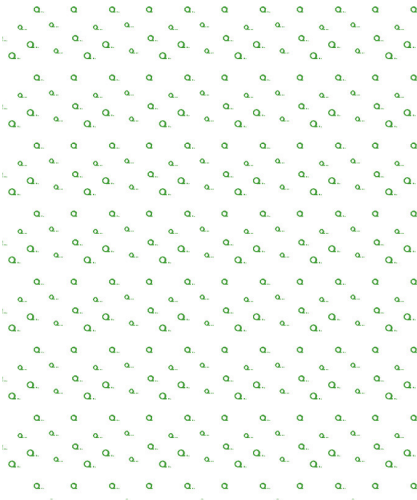

---

Description: Green362 Evergreen Tree Fill

Component Reference: A00012

MIL-STD-2410 Reference: AP-60

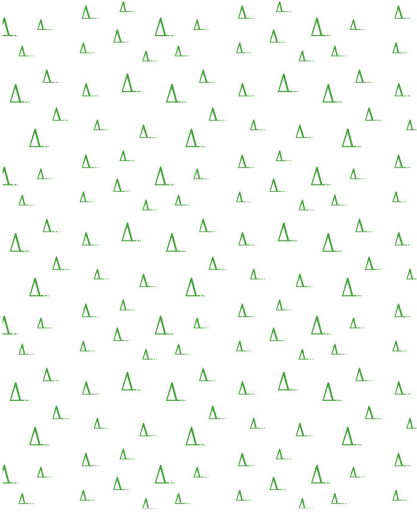

Description: Green362 Grassland Fill

Component Reference: A00126

MIL-STD-2410 Reference: No existing MIL\_STD\_2410 area pattern.

Note: Match sample pattern provided.

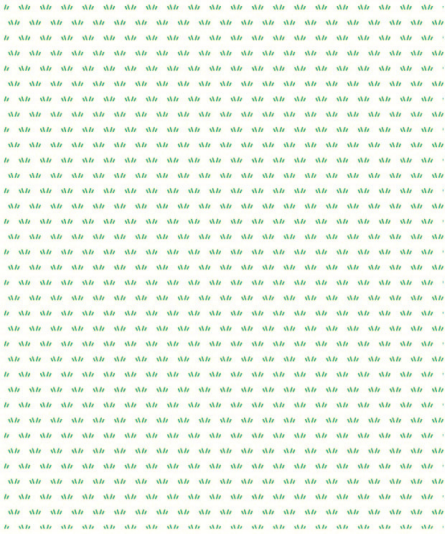

Description: Green362 Greenhouse Fill

Component Reference: A00124

MIL-STD-2410 Reference: LP-6

Note: 38% coverage, 34L, 45/135 degree angle lines

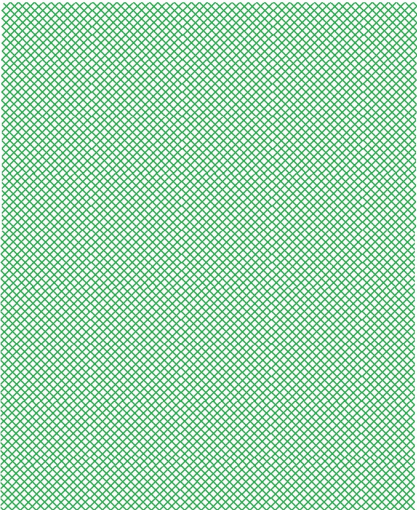

Description: Green362 Mangrove Fill

Component Reference: A00025

MIL-STD-2410 Reference: AP-8

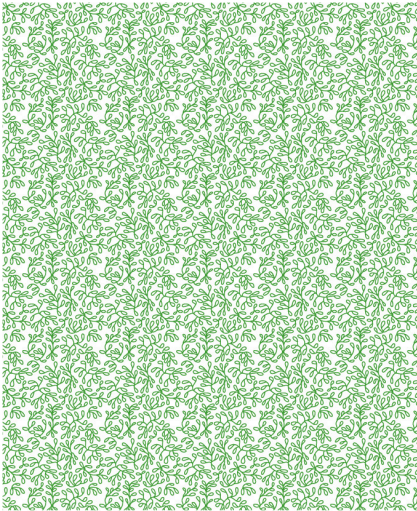

---

Description: Green362 Mixed Tree Fill

Component Reference: A00013

MIL-STD-2410 Reference: AP-63

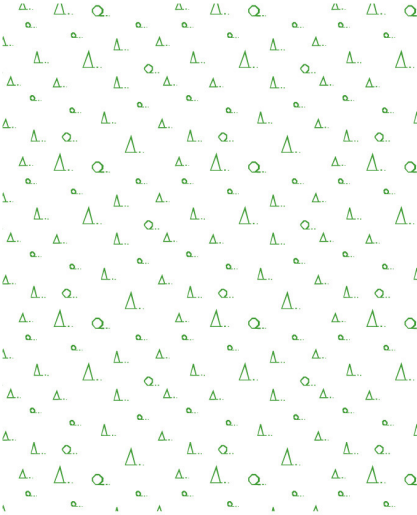

Description: Green362 Nipa Fill

Component Reference: A00024

MIL-STD-2410 Reference: AP-7

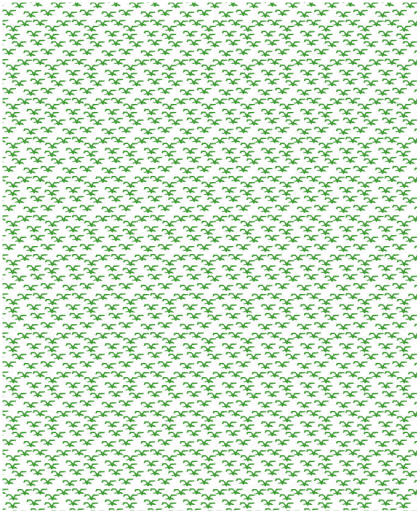

---

Description: Green362 Orchard / Plantation Fill

Component Reference: A00028

MIL-STD-2410 Reference: AP-74

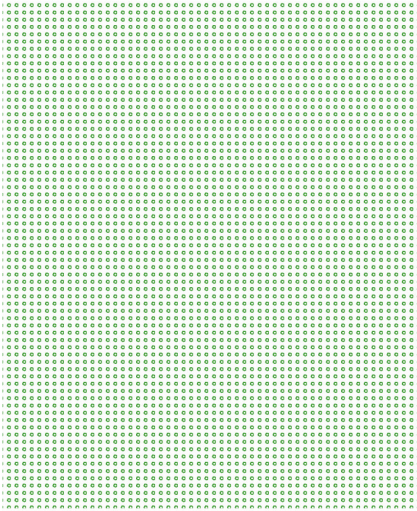

Description: Green362 Scattered Trees Fill

Component Reference: A00047

MIL-STD-2410 Reference: AP-44

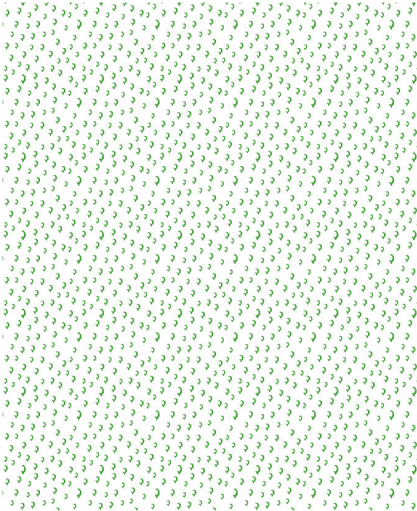

---

Description: Green362 Scrub / Thicket Fill

Component Reference: A00027

MIL-STD-2410 Reference: AP-68

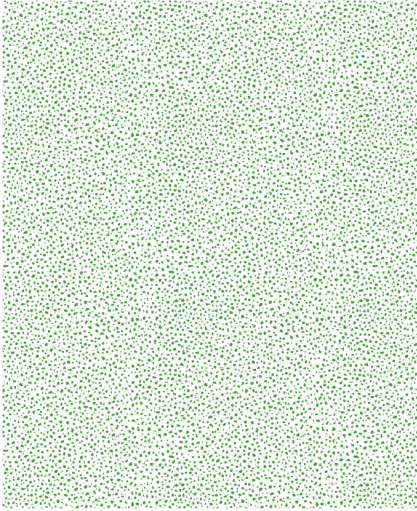

Description: Green362 Vineyard / Hops Fill

Component Reference: A00029

MIL-STD-2410 Reference: AP-77

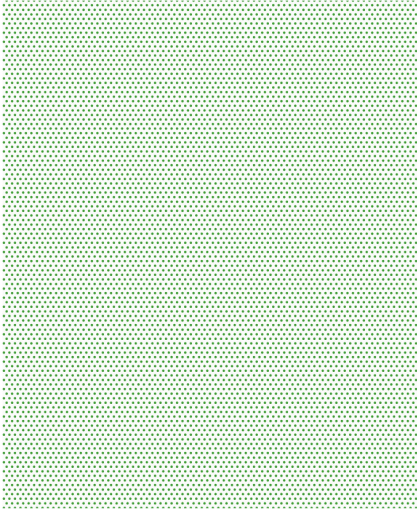

## Annex J – Generalization and Label Rules

The generalization and label rules associated with individual feature symbols in Annex A are listed here by rule number, grouped by its 2-letter rule category designator and then sequentially within that group. Rules are listed once, though a particular rule may be associated with multiple feature symbols.

**Generalization** rules may modify the geospatial data being input into the portrayal process to achieve the desired result.

**GA** – Generalization Aggregation rules blend or combine identical contiguous features.

**GC** – Generalization Change rules indicate when a geometry will be altered or changed from one delineation to another.

**Label** rules indicate how labels are placed with respect to their related geometry and/or symbol.

**LP** - Label Placement rules indicate the initial baseline placement of labels used as a part of a symbol, prior to finishing activities.



**GA - Generalization Aggregation rules**

- GA-9999 Contiguous line/curve and area/surface features that have matching symbol criteria and label string outputs shall be blended to form a single feature.

**GC - Generalization Change rules**

- GC-9978 For area/surface General Buildings (AL015) with a Feature Function (FFN) of Hospital or House of Worship Type (HWT) of Minaret, Pagoda, Stupa, or Temple; and if the area (ARA) is less than the square meters indicated for the scale (1:50,000 -- 5,625 sq. m; 1:100,000 -- 22,500 sq. m), the area/surface delineation shall be replaced with a point delineation. The point delineation shall be placed at the centroid of the area/surface feature.
- GC-9979 Replace the area/surface delineation with a line/curve delineation. The line/curve delineation shall be placed equidistant from each side of the length of the area/surface feature.
- GC-9981 If the length (LEN) is less than the number of meters indicated for the scale (1:50,000 -- 50 m; 1:100,000 -- 100 m), then the length shall be increased to that number of meters. If the width (WID) is less than the indicated number of meters for the scale (1:50,000 -- 40 m; 1:100,000 -- 80 m), then the width shall be increased to that number of meters. Lengths and widths shall be increased equally in each direction from the centroid of the area/surface feature.
- GC-9982 If the area (ARA) is less than the square meters indicated for the scale (1:50,000 -- 62,500 sq. m; 1:100,000 -- 250,000 sq. m), the area/surface delineation shall be replaced with a point delineation. The point delineation shall be placed at the centroid of the area/surface feature.
- GC-9983 If Height Above surface Level (HGT)  $\geq$  46 meters, then the area/surface delineation shall be replaced with a point delineation. The point delineation shall be placed at the centroid of the area/surface feature.
- GC-9985 Replace the area/surface delineation with a point delineation. The point delineation shall be placed at the centroid of the area/surface feature.
- GC-9986 Replace the line/curve delineation with a point delineation. The point delineation shall be placed at the midpoint of the line/curve feature
- GC-9988 If the length (LEN) is less than the number of meters indicated for the scale (1:50,000 -- 125 m; 1:100,000 -- 250 m), then length shall be increased to that number of meters. Lengths shall be increased equally in each direction from the midpoint of the line/curve feature.
- GC-9989 If the width (WID) is less than the number of meters indicated for the scale (1:50,000 -- 50 m; 1:100,000 -- 100 m), the area/surface delineation shall be replaced with a line/curve delineation. The line/curve delineation shall be placed equidistant from each side of the length of the area/surface feature.
- GC-9990 If the width (WID) is less than the number of meters indicated for the scale (1:50,000 -- 25 m; 1:100,000 -- 50 m), the area/surface delineation shall be replaced with a line/curve delineation. The line/curve delineation shall be placed equidistant from each side of the length of the area/surface feature.
- GC-9991 If the length (LEN) is less than the number of meters indicated for the scale (1:50,000 -- 25 m; 1:100,000 -- 50 m), then the length shall be increased to that number of meters. Lengths shall be increased equally in each direction from the center of the line/curve feature.
- GC-9992 If the length (LEN) is less than the number of meters indicated for the scale (1:50,000 -- 100 m; 1:100,000 -- 200 m), then the length shall be increased to that number of meters. Lengths shall be increased equally in each direction from the midpoint of the line/curve feature.
- GC-9993 If the surface area (ARA), after applying GC-9994, where applicable, is less than the square meters indicated for the scale (1:50,000 -- 1,600 sq. m; 1:100,000 -- 6,400 sq. m), the area/surface delineation shall be replaced with a point delineation. The point delineation shall be placed at the centroid of the area/surface feature.
- GC-9994 If the width (WID) is less than the number of meters indicated for the scale (1:50,000 -- 25 m; 1:100,000 -- 50 m), then the width shall be increased to that number of meters. Widths shall be increased equally in each direction from the centroid of the area/surface feature.
- GC-9995 If the width of crest (WOC) or width (WID) is less than the number of meters indicated for the scale (1:50,000 -- 100 m;

1:100,000 -- 200 m), the area/surface delineation shall be replaced with a line/curve delineation. The line/curve delineation shall be placed equidistant from each side of the length of the area/surface feature.

- GC-9996 If the length (LEN) is less than the number of meters indicated for the scale (1:50,000 -- 50 m; 1:100,000 -- 100 m), then length shall be increased to that number of meters. Lengths shall be increased equally in each direction from the midpoint of the line/curve feature.
- GC-9997 If the length (LEN) is less than the number of meters indicated for the scale (1:50,000 -- 75 m; 1:100,000 -- 150 m), then the length shall be increased to that number of meters. Lengths shall be increased equally in each direction from the midpoint of the line/curve feature.
- GC-9999 If the area (ARA) is less than the square meters indicated for the scale (1:50,000 -- 15,625 sq. m; 1:100,000 -- 62,500 sq. m), the area/surface delineation shall be replaced with a point delineation. The point delineation shall be placed at the centroid of the area/surface feature.

### LP - Label Placement rules

- LP-0050 Variable type sizes shall be placed for area/surface features per area/surface sizes at map/chart scale: 6 point  $\leq$  770 mm sq. area and  $\leq$  14 mm width; 7 point  $\leq$  2,300 mm sq. area and  $\leq$  28 mm width; 8 point  $\leq$  3,600 mm sq. area and  $\leq$  36 mm width; 9 point  $\leq$  5,200 mm sq. area and  $\leq$  44 mm width; 10 point  $\leq$  9,800 mm sq. area and  $\leq$  62 mm width; 12 point  $\leq$  16,650 mm sq. area and  $\leq$  84 mm width; 14 point  $\leq$  25,000 mm sq. area and  $\leq$  105 mm width; 16 point  $\leq$  36,000 mm sq. area and  $\leq$  125 mm width; 18 point  $>$  36,000 mm sq. area and  $>$  125 mm width. The type size may be adjusted depending on the length of the character string. However in no case shall the type size be less than 6 point.
- LP-0051 Variable type sizes shall be used for line/curve features per line/curve length at map/chart scale: 6 point -  $\leq$  80 mm length; 7 point - 81-120 mm length; 8 point 121-160 mm length; 9 point -  $>$  160 mm length. The type size may be adjusted depending on the length of the character string. However in no case shall the type size be less than 6 point.
- LP-0062 Area/surface Aqueduct, (BH010), Canal (BH020), Ditch (BH030), and River (BH140), shall be labeled with upper case type centered within its limits, with type size proportional to the width (WID) of the feature.
- LP-0073 The Highest Elevation (ZVH) label for Spot Elevation (CA030) and the Base Elevation (BEL) label for Survey Point (ZB035) shall be placed 0.5 mm from the respective symbol, parallel to the south neatline. The top of the label aligns to the horizontal center and to the right of the symbol [southeast]. If there is an additional label for either feature, it is placed 0.5 mm above and aligned with the elevation label.
- LP-3505 The label for point features, and small line/curve and area/surface features, shall be placed 0.5 mm from the respective symbol, parallel to the south neatline. The bottom of the label aligns to the horizontal center and to the right of the symbol [northeast].
- LP-3506 The label for area/surface features shall be centered within the feature, parallel to the south neatline.
- LP-3630 The label for line/curve features shall be placed 0.5 mm above, parallel to, and centered on the respective symbol.
- LP-3987 Elevation Contour (CA010) labels shall be centered on the axis of the Elevation Contour line with the top of the label towards the higher elevation.
- LP-3996 Road Route Marker (no code) symbols shall be shown centered on the associated Ice Route (AQ075) and Road (AP030) symbol and positioned parallel to the south neatline. The route identification shall be centered within the route marker, reading left to right.
- LP-4813 If any generic term (exact or similar) contained in a label string (attribute value or descriptive term) appears in a geographic name (NAM), the term(s) shall not be shown as part of the label, i.e. "[Panama Canal] [Canal]" would be "Panama Canal"; "[Ahvaz Oil Field] [hydrocarbons field]" would be "Ahvaz Oil Field"; "[Norfolk Navy Base] [military installation]" would be "Norfolk Navy Base"; "[Rosecroft Raceway] [racetrack]" would be "Rosecroft Raceway"; "[Navy Pier] [recreational pier]" would be "Navy Pier"; "[Ace Recycling Center] [recycling site]" would be "Ace Recycling Center"; "[Red Bull Arena] [stadium]" would be "Red Bull Arena"; "[Smithsonian National Zoological Park] [zoo]" would be "Smithsonian National Zoological Park".
- LP-9950 If a label string contains the attribute "[Condition of Facility]" and the enumerant value is "Under Construction", then "Under Construction" shall be changed to "Construction" in the label string.

- LP-9990 A combined label shall be shown for each Land Aerodrome (GB005) and its associated Runway(s) (GB055). The label shall consist of elements of the label string for the Land Aerodrome (official AAFIF name, ICAO identification, physical condition) followed by the label string for the associated Runway (surface composition), followed by the aerodrome elevation. When a land aerodrome consists of more than one runway, the surface composition for the longest intact runway shall be shown. If all runways are not intact, the surface composition for the longest runway shall be shown. The label for Land Aerodrome and associated Runway is centered within the Land Aerodrome, parallel to the south neatline. The label string elements are stacked vertically, 0.5 mm apart, and centered to each other.
- LP-9991 The label string elements for line/curve vertical obstructions shall be stacked vertically, 0.5 mm apart, centered to each other and are placed 0.5 mm above, parallel to, and centered on the respective symbol.
- LP-9992 The label for point vertical obstructions and offshore features shall be placed 0.5 mm to the right of the symbol, parallel to the south neatline. The label string elements shall be stacked vertically, 0.5 mm apart, and centered to each other. The vertical center of the stacked elements shall align to the vertical axis of the symbol.
- LP-9993 If Divided (SEP) is True (1001) for a Road, the Lane Count (LTN) of the two travelled way delineations are added together and this total shall be used for the "LTN" portion of the label string.
- LP-9994 The label string elements for Administrative Boundary (FA000) features where there is "No Defined Boundary" (BST = 4) shall be stacked vertically, 0.5 mm apart, and centered to each other. The stacked elements shall be aligned parallel to the south neatline.
- LP-9995 The labels for Administrative Boundary (FA000) features shall be placed 0.5 mm from and parallel to the Administrative Boundary symbol. The labels shall be aligned across the Administrative Boundary from each other with each label on the respective side of the Administrative Boundary.
- LP-9996 The labels for Administrative Division (FA003) features shall be placed 0.5 mm from and parallel to the inside edge of the area/surface feature. The labels shall be aligned with any adjacent Administrative Division with the same BAL (BGN Administrative Level) attribute.
- LP-9997 Variable type sizes shall be used for linear surface features, at map/chart scale: 7 point - ≤ 65 mm length; 8 point 66-80 mm length; 9 point - 81-100 mm length; 10 point 101-120 mm length; 12 point 121-160 mm length; 14 point 161-200 mm length; 16 point >200 mm length. The type size may be adjusted depending on the length of the character string. However in no case shall the type size be less than 6 point.
- LP-9998 The "H" in the helipad symbol shall be oriented correctly when read from the south neatline.
- LP-9999 If any attribute value is Unknown (0), Multiple (996), Not Populated (997), Not Applicable (998), or Other (999), the label string for that attribute shall not be shown and any remaining part of the label string is appropriately adjusted. For mixed case labels, only the first letter of the first word in a label string shall be capitalized, except when part of a proper name (NAM).

## **Annex K – Glossary**

The following annex contains definitions of commonly used terms found within this Portrayal Standard.

#### Area - Fill

- A fill screen or pattern depicted within an area symbol.

#### Area – Pattern (AP)

- A unique and continuous graphic pattern depicted within an area symbol. Area patterns applicable to this standard are defined in MIL-STD-2410.

#### Arrow

- A symbol or component of a symbol indicating direction, or a vector.

#### Attribute

- A characteristic of a feature.

#### Cased

- Two parallel lines representing a linear feature.

#### Centroid

- The geometric center of the object's shape.

#### Color

- The quality of an object or substance with respect to light reflected by the object, usually determined visually by measurement of hue, saturation, and brightness of the reflected light; saturation or chroma; hue.

#### Color Token

- A name by which a color is known. Color tokens are associated with different colors optimized for the viewing condition, such as red-light readable, or red and blue/green-light readable.

#### Component

- An area, line or point geometry used in the construction of a symbol.

#### Concatenate

- To link or join together, especially in a chain or series.

#### Dash Spacing

- The distance between two consecutive dashes.

#### Distance between lines/line spacing

- Distance measured from closest edges of two lines

#### Feature

- An abstraction of a real world phenomenon.

#### Fill

- The appropriate color or pattern depicted within or overprinting the symbol.

#### Font

- The characteristic or form of a typeface.

#### Label

- Labels consist of a variety of terminology and abbreviations, descriptive, or identifying, that are either free-standing (geographic names, text description), or directly associated with a graphic symbol (point, line, area).

#### Line Weight

- The thickness of a line (in millimeters) measured between outside edges.

#### Line Fill

- A line pattern (LP) depicted within the bounding outlines of an area symbol.

#### Line Pattern (LP)

- A unique and continuous graphic pattern depicted within an area symbol. Line patterns applicable to this standard are defined in MIL-STD 2410.

#### Line Style

- A group of parameters (e.g. line weight, color, dash length, dash spacing) which defines the appearance of the symbology (or portion of a symbology) applied to a linear component.

#### Lower case

- All letters of a word or words are in lower case text. All numbers are considered lower case text in this standard.

#### Mixed case

- The first letter in the first word entry is a capital letter, followed by all lower case text.

#### Open circle

- A circle whose dimensions are measured across the circle, outside perimeter edge to outside perimeter edge.

#### Open square

- A square whose dimensions are measured across the square, outside perimeter edge to outside perimeter edge.

#### Origin (of symbol)

- The place on a symbol that corresponds to the geographic location of the object it represents.

#### Perimeter

- The limits of an area feature as centered on the peripheral edge of that feature.

#### Portrayal

- The presentation of information to users.

#### Portrayal specification

- A collection of operations applied to the feature instance to portray it.

#### Screen

- A regular pattern of dots, defined by a predetermined percentage (100% being solid) used to create tones of a given color.

#### Shape

- A unique graphic symbol with a fixed geometry and used primarily for point features. Shape specifications are defined in Annex H.

#### Symbol

- An object that represents information.

#### Symbol parameter

- Basic drawing instructions needed to construct the symbol graphic.

#### Symbol rule

- A rule that is applied to the feature to determine which portrayal specification to use.

#### Tick

- A short line located at specific intervals along a linear symbol and normally positioned perpendicular to that line.

#### Type

- The letters, numbers, diacritics, etc., associated with labels.

Type size

- The size of type, measured in point size.

Type style

- Specifications on capitalization and appearance of the type, such as normal, light, bold, italic and condensed.

Upper case

- All letters of a word or words are in capital letters.



## Annex L – Feature Symbol Index

The features symbolized in Annex A are listed here based on two different sort orders. The first index is sorted alphabetically by **DFDD Feature Name/Alternate Name**. Included with this listing are alternate (or “former”) names by which the community may traditionally know the feature/symbol as. The second index is sorted by **Feature Code** (DFDD-like Code).

The page numbers in the Feature Symbol Index provide the location in Annex A where the given feature information begins. If there is more than one symbol for the selected feature, the reader may have to scroll down through the document to locate the symbol which he/she is interested in reviewing.

**Note** – the bookmark tool on the left panel of the PDF also provides hyperlinks to each feature and symbol.

## Sorted By DFDD Feature Name/Alternate Name

29 May 2015

DFDD Feature Name / Alternate Name	DFDD Feature Name	Feature Code	Page
Administrative Boundary	Administrative Boundary	FA000	A-1
Administrative Division	Administrative Division	FA003	A-3
Aerial	Tower	AL241	A-330
Aerial Cableway	Cableway	AT041	A-35
Aerial, Dish	Dish Aerial	AT010	A-72
Aerodrome, Land	Land Aerodrome	GB005	A-169
Aerodrome, Water	Water Aerodrome	GB065	A-347
Aeronautical Obstacle	Aeronautical Obstacle	GB220	A-6
Aeronautical Obstacle	Vertical Obstruction	No Code	A-342
Aeronautical Radio Navigation Service	Aeronautical Radio Navigation Service	GA034	A-7
Aircraft Hangar	Aircraft Hangar	GB230	A-8
Aircraft Revetment	Aircraft Revetment	GB050	A-10
Airfield	Land Aerodrome	GB005	A-169
Amusement Park	Amusement Park	AK030	A-11
Animal Park	Zoo	AK180	A-362
Animal Pen	Holding Pen	AJ030	A-163
Approach Lighting System	Approach Lighting System	GB485	A-13
Apron	Apron	GB015	A-14
Aqueduct	Aqueduct	BH010	A-14
Archeological Site	Archeological Site	AL012	A-19
Athletic Field	Sports Ground	AK040	A-311
Bamboo	Cane	EC010	A-44
Beach	Beach	BA050	A-20
Benchmark	Survey Point	ZB050	A-323
Berthing Structure	Berthing Structure	BB190	A-22
Bluff	Steep Terrain Face	DB010	A-315
Bog	Bog	BH015	A-24
Boundary, Administrative	Administrative Boundary	FA000	A-1
Boundary, Land Water	Land Water Boundary	BA010	A-171
Breakwater	Breakwater	BB041	A-25
Bridge	Bridge	AQ040	A-27
Bridge Tower	Tower	AL241	A-330
Bucket Elevator	Conveyor	AF020	A-59
Building	General Building	AL015	A-124
Building, Fortified	Fortification	AH050	A-122
Built Up Area	Built Up Area	AL020	A-32
Bunker, Surface	Surface Bunker	AM060	A-322
Cable, Communication	Communication Line	AT060	A-55
Cable, Power Line	Power Line	AT030	A-200
Cableway	Cableway	AT041	A-35
Cairn	Cairn	AL025	A-36

## Sorted By DFDD Feature Name/Alternate Name

29 May 2015

DFDD Feature Name / Alternate Name	DFDD Feature Name	Feature Code	Page
Camp	Camp	AI030	A-37
Camp Site	Camp Site	AK060	A-38
Canal	Canal	BH020	A-39
Cane	Cane	EC010	A-44
Car Line, Railway	Railway	AN010	A-216
Car Park	Vehicle Lot	AQ140	A-342
Cart Track	Cart Track	AP010	A-44
Catalytic Cracker	Catalytic Cracker	AC020	A-45
Causeway Structure	Causeway Structure	AQ063	A-46
Cave Dwelling	Cave Mouth	DB029	A-47
Cave Mouth	Cave Mouth	DB029	A-47
Cemetery	Cemetery	AL030	A-47
Checkpoint	Checkpoint	AH070	A-53
Chimney	Smokestack	AF010	A-305
Church	General Building	AL015	A-124
Cinder Cone	Volcano	DB180	A-345
Circular Irrigation System	Circular Irrigation System	AJ010	A-54
Cistern	Cistern	BI010	A-54
Cleared Way	Cleared Way	EC040	A-55
Clearing, Forest	Forest Clearing	EC060	A-122
Cliff	Steep Terrain Face	DB010	A-315
Cliff, Ice	Ice Cliff	BJ040	A-165
Coastal Shoreline	Land Water Boundary	BA010	A-171
Communication Line	Communication Line	AT060	A-55
Communication Station	Communication Station	AT050	A-57
Consulate	General Building	AL015	A-124
Contour, Elevation	Elevation Contour	CA010	A-79
Control Point	Survey Point	ZB050	A-323
Control Tower	Tower	AL241	A-330
Conveyor	Conveyor	AF020	A-59
Conveyor Cable	Cableway	AT041	A-35
Cooling Facility	Facility	AL010	A-110
Cooling Tower	Tower	AL241	A-330
Corral	Holding Pen	AJ030	A-163
Crane	Crane	AF040	A-61
Crevasse	Crevasse	BJ031	A-61
Crevice	Crevice	DB061	A-63
Crop Land	Crop Land	EA010	A-64
Cultivated Land	Crop Land	EA010	A-64
Culvert	Culvert	AQ065	A-65
Cut Line	Cut Line	DB071	A-66

## Sorted By DFDD Feature Name/Alternate Name

29 May 2015

DFDD Feature Name / Alternate Name	DFDD Feature Name	Feature Code	Page
Dam	Dam	BI020	A-67
Defensive Revetment	Aircraft Revetment	GB050	A-10
Depot, Storage	Storage Depot	AM010	A-316
Depression Contour	Elevation Contour	CA010	A-79
Dike/Dyke	Dam	BI020	A-67
Diplomatic Building	General Building	AL015	A-124
Disappearing Stream	Vanishing Point	BH145	A-341
Dish Aerial	Dish Aerial	AT010	A-72
Disposal Site	Disposal Site	AB000	A-72
Dissipating Stream	Vanishing Point	BH145	A-341
Distorted Surface	Soil Surface Region	DA010	A-306
Ditch	Ditch	BH030	A-73
Divided Highway	Road	AP030	A-257
Dragon's Teeth	Dragon's Teeth	AL060	A-75
Dry Dock	Dry Dock	BB090	A-77
Dunes, Sand	Sand Dunes	DB170	A-292
Dyke	Embankment	DB090	A-98
Earthwork, Engineered	Engineered Earthwork	AH025	A-100
Electric Power Distribution Line	Power Line	AT030	A-200
Electric Power Plant	Electric Power Station	AD010	A-77
Electric Power Station	Electric Power Station	AD010	A-77
Electric Power Substation	Power Substation	AD030	A-201
Electric Power Transmission Line	Power Line	AT030	A-200
Elevation Contour	Elevation Contour	CA010	A-79
Elevation, Spot	Spot Elevation	CA030	A-312
Embankment	Embankment	DB090	A-98
Embassy	General Building	AL015	A-124
Engineered Earthwork	Engineered Earthwork	AH025	A-100
Entrance and/or Exit	Entrance and/or Exit	AQ090	A-101
Escarpment	Cut Line	DB071	A-66
Escarpment	Steep Terrain Face	DB010	A-315
Esker	Esker	DB100	A-101
Extraction Mine	Extraction Mine	AA010	A-102
Extraction Mine/Quarry	Quarry	AA012	A-210
Facility	Facility	AL010	A-110
Facility, Fish Farm	Fish Farm Facility	BH051	A-118
Facility, Heating	Heating Facility	AD050	A-158
Facility, Processing	Processing Facility	AC000	A-202
Fairground	Fairground	AK090	A-114
Falls, Water	Waterfall	BH180	A-351
Farm, Fish	Fish Farm Facility	BH051	A-118

**Sorted By DFDD Feature Name/Alternate Name**

29 May 2015

DFDD Feature Name / Alternate Name	DFDD Feature Name	Feature Code	Page
Farmland	Crop Land	EA010	A-64
Faultline	Geologic Fault	DB110	A-143
Fence	Fence	AL070	A-115
Ferry Crossing	Ferry Crossing	AQ070	A-115
Filtration Beds	Water Treatment Bed	BH040	A-350
Firebreak	Cleared Way	EC040	A-55
Firing Range	Firing Range	FA015	A-116
Fish Farm Facility	Fish Farm Facility	BH051	A-118
Flare Pipe	Flare Pipe	AF070	A-120
Flood Control Structure	Dam	BI020	A-67
Flood Control Structure	Water Gate	BI041	A-349
Flow Arrow, River	River Flow Arrow	No Code	A-257
Flume	Flume	BH060	A-120
Flume	Penstock	BH110	A-193
Footbridge	Bridge	AQ040	A-27
Footpath	Trail	AP050	A-333
Ford	Ford	BH070	A-121
Forest	Wood	EC030	A-357
Forest Clearing	Forest Clearing	EC060	A-122
Fortification	Fortification	AH050	A-122
Fortified Building	Fortification	AH050	A-122
Fuel Storage Facility	Facility	AL010	A-110
Fumarole	Geothermal Outlet	DB115	A-146
Gas Field	Hydrocarbons Field	AA052	A-165
Gas Rig	Rig	AA040	A-254
Gas Station	General Building	AL015	A-124
Gate, Sluice	Sluice Gate	BI040	A-304
Gate, Water	Water Gate	BI041	A-349
General Building	General Building	AL015	A-124
Geologic Fault	Geologic Fault	DB110	A-143
Geophysical Data Track Line	Geophysical Prospecting Grid	FA090	A-144
Geophysical Prospecting Grid	Geophysical Prospecting Grid	FA090	A-144
Geopolitical Entity	Geopolitical Entity	FA002	A-144
Geothermal Feature	Geothermal Outlet	DB115	A-146
Geothermal Outlet	Geothermal Outlet	DB115	A-146
Geyser	Geothermal Outlet	DB115	A-146
Glacier	Glacier	BJ030	A-147
Golf Course	Golf Course	AK100	A-148
Grain Elevator	Grain Elevator	AM030	A-148
Grain Storage Structure	Grain Storage Structure	AM020	A-150
Grassland	Grassland	EB010	A-152

## Sorted By DFDD Feature Name/Alternate Name

29 May 2015

DFDD Feature Name / Alternate Name	DFDD Feature Name	Feature Code	Page
Grave, Isolated	Cemetery	AL030	A-47
Gravel	Moraine	BJ020	A-185
Gravel	Soil Surface Region	DA010	A-306
Greenhouse	Greenhouse	AJ110	A-153
Groin	Groin	BB043	A-154
Ground Surface	Soil Surface Region	DA010	A-306
Gully	Gully	DB200	A-156
Hangar, Aircraft	Aircraft Hangar	GB230	A-8
Harbour	Harbour	BB005	A-157
Hardstand	Apron	GB015	A-14
Hazardous Rock	Hazardous Rock	BD130	A-158
Heating Facility	Heating Facility	AD050	A-158
Hedgerow	Hedgerow	EA020	A-160
Helipad	Helipad	GB030	A-161
Heliport	Heliport	GB035	A-162
High Tension Power Transmission Line	Power Line	AT030	A-200
Highway	Road	AP030	A-257
Highway Route Marker	Road Route Marker	No Code	A-279
Historical Site	Archeological Site	AL012	A-19
Holding Pen	Holding Pen	AJ030	A-163
Hop Field	Hop Field	EA055	A-164
Horizontal Control Point	Survey Point	ZB050	A-323
Hospital	General Building	AL015	A-124
Hot Spring	Geothermal Outlet	DB115	A-146
Hulk	Wreck	BD180	A-361
Hut	Hut	AL099	A-164
Hydrocarbon Products Facility	Processing Facility	AC000	A-202
Hydrocarbons Field	Hydrocarbons Field	AA052	A-165
Ice Cliff	Ice Cliff	BJ040	A-165
Ice Field	Snow Ice Field	BJ100	A-306
Ice Peak	Ice Peak	BJ060	A-166
Ice Route	Ice Route	AQ075	A-166
Incline Railway	Railway	AN010	A-216
Inland Waterbody	Lake	BH080	A-168
Inland Waterbody	Reservoir	BH130	A-251
Irrigation System, Circular	Circular Irrigation System	AJ010	A-54
Island	Island	BA030	A-167
Isolated Tree	Wood	EC030	A-357
Jetty	Training Wall	BB140	A-333
Kanat/Karez	Aqueduct	BH010	A-14
Lake	Lake	BH080	A-168

## Sorted By DFDD Feature Name/Alternate Name

29 May 2015

DFDD Feature Name / Alternate Name	DFDD Feature Name	Feature Code	Page
Land Aerodrome	Land Aerodrome	GB005	A-169
Land Subject To Inundation	Land Subject To Inundation	BH090	A-170
Land Water Boundary	Land Water Boundary	BA010	A-171
Launch Pad	Launch Pad	GB040	A-172
Leader Line	Leader Line	No Code	A-173
Levee	Embankment	DB090	A-98
Lighthouse	Tower	AL241	A-330
Lighting System, Approach	Approach Lighting System	GB485	A-13
Lock	Lock	BI030	A-174
Mangrove Swamp	Mangrove Swamp	ED030	A-176
Manmade Shoreline	Seawall	BB230	A-295
Mariculture Site	Mariculture Site	BH050	A-177
Maritime Signal Station	Maritime Signal Station	BB155	A-178
Marsh	Marsh	ED010	A-180
Mast	Tower	AL241	A-330
Mast, Mooring	Mooring Mast	AQ110	A-185
Memorial Monument	Memorial Monument	AL130	A-181
Military Installation	Military Installation	SU001	A-181
Minaret	General Building	AL015	A-124
Mine	Extraction Mine	AA010	A-102
Mine/Quarry	Quarry	AA012	A-210
Mineral Pile	Mineral Pile	AM040	A-183
Monument	Memorial Monument	AL130	A-181
Mooring Mast	Mooring Mast	AQ110	A-185
Moraine	Moraine	BJ020	A-185
Mosque	General Building	AL015	A-124
Motor Vehicle Station	General Building	AL015	A-124
Motorway	Road	AP030	A-257
Mountain Pass	Mountain Pass	DB150	A-186
Named Location	Named Location	ZD040	A-186
Native Settlement	Settlement	AL105	A-296
Natural Pool	Natural Pool	BH170	A-187
Nipa	Swamp	ED020	A-325
Non Water Well	Well	AA050	A-352
Nunatak	Ice Peak	BJ060	A-166
Oasis	Oasis	EC020	A-188
Obstruction, Aeronautical	Aeronautical Obstacle	GB220	A-6
Obstruction, Vertical	Vertical Obstruction	No Code	A-342
Offshore Construction	Offshore Platform	BD110	A-189
Offshore Platform	Offshore Platform	BD110	A-189
Oil Field	Hydrocarbons Field	AA052	A-165

## Sorted By DFDD Feature Name/Alternate Name

29 May 2015

DFDD Feature Name / Alternate Name	DFDD Feature Name	Feature Code	Page
Oil Rig	Rig	AA040	A-254
Open Water, Inland	Lake	BH080	A-168
Open Water, Inland	Reservoir	BH130	A-251
Open Water, Tidal	Tidal Water	BA040	A-329
Orchard	Orchard	EA040	A-190
Overpass	Bridge	AQ040	A-27
Overrun	Stopway	GB045	A-316
Pagoda	General Building	AL015	A-124
Parapet	Engineered Earthwork	AH025	A-100
Park	Park	AK120	A-190
Park, Amusement	Amusement Park	AK030	A-11
Park, Animal	Zoo	AK180	A-362
Parking Lot	Vehicle Lot	AQ140	A-342
Particle Accelerator	Particle Accelerator	AL140	A-192
Pass, Mountain	Mountain Pass	DB150	A-186
Penstock	Penstock	BH110	A-193
Petrol Station	General Building	AL015	A-124
Pier	Recreational Pier	AK190	A-247
Pile	Structural Pile	BD100	A-321
Pinnacle	Rock Formation	DB160	A-283
Pipe, Flare	Flare Pipe	AF070	A-120
Pipeline	Pipeline	AQ113	A-195
Place Name	Named Location	ZD040	A-186
Placer Mine	Extraction Mine	AA010	A-102
Plantation	Orchard	EA040	A-190
Platform, Offshore	Offshore Platform	BD110	A-189
Plaza	Public Square	AL170	A-206
Point of Change	Point of Change	No Code	A-199
Pond	Lake	BH080	A-168
Pond, Settling	Settling Pond	AC030	A-298
Pool, Natural	Natural Pool	BH170	A-187
Pool, Swimming	Swimming Pool	AK170	A-326
Power Distribution Line	Power Line	AT030	A-200
Power Line	Power Line	AT030	A-200
Power Station	Electric Power Station	AD010	A-77
Power Substation	Power Substation	AD030	A-201
Power Transformer Station	Power Substation	AD030	A-201
Power Transmission Line	Power Line	AT030	A-200
Processing Facility	Processing Facility	AC000	A-202
Promenade	Recreational Pier	AK190	A-247
Prospect, Mine	Extraction Mine	AA010	A-102



## Sorted By DFDD Feature Name/Alternate Name

29 May 2015

DFDD Feature Name / Alternate Name	DFDD Feature Name	Feature Code	Page
Protection Shed	Protection Shed	AL210	A-205
Public Square	Public Square	AL170	A-206
Pumping Station	Pumping Station	AQ116	A-207
Pylon	Pylon	AT042	A-209
Qanat	Aqueduct	BH010	A-14
Quarry	Extraction Mine	AA010	A-102
Quarry	Quarry	AA012	A-210
Quay	Berthing Structure	BB190	A-22
Racetrack	Racetrack	AK130	A-214
Radar Station	Radar Station	AT045	A-215
Radio Mast	Tower	AL241	A-330
Radio Navigation Service, Aeronautical	Aeronautical Radio Navigation Service	GA034	A-7
Railroad	Railway	AN010	A-216
Railway	Railway	AN010	A-216
Railway Roundhouse	Roundhouse	AN076	A-285
Railway Sidetrack	Railway Sidetrack	AN050	A-237
Railway Station	Transportation Station	AQ125	A-334
Railway Turntable	Railway Turntable	AN075	A-244
Railway Yard	Railway Yard	AN060	A-245
Ramp, Shoreline	Slipway	BB240	A-303
Rampart	Engineered Earthwork	AH025	A-100
Rapids	Rapids	BH120	A-245
Recreational Pier	Recreational Pier	AK190	A-247
Recycling Site	Recycling Site	AB010	A-248
Redoubt	Engineered Earthwork	AH025	A-100
Reef	Reef	BD120	A-249
Refinery	Processing Facility	AC000	A-202
Reservoir	Reservoir	BH130	A-251
Rest Area	Roadside Rest Area	AQ135	A-281
Revetment, Aircraft	Aircraft Revetment	GB050	A-10
Rice Field	Rice Field	BH135	A-253
Rig	Rig	AA040	A-254
River	River	BH140	A-254
River Flow Arrow	River Flow Arrow	No Code	A-257
River Vanishing Point	Vanishing Point	BH145	A-341
Road	Road	AP030	A-257
Road Route Marker	Road Route Marker	No Code	A-279
Road, Ice	Ice Route	AQ075	A-166
Roadside Rest Area	Roadside Rest Area	AQ135	A-281
Rock	Hazardous Rock	BD130	A-158
Rock Formation	Rock Formation	DB160	A-283

## Sorted By DFDD Feature Name/Alternate Name

29 May 2015

DFDD Feature Name / Alternate Name	DFDD Feature Name	Feature Code	Page
Roundhouse	Roundhouse	AN076	A-285
Route Marker	Road Route Marker	No Code	A-279
Row of Trees	Wood	EC030	A-357
Ruins	Ruins	AL200	A-286
Runway	Runway	GB055	A-287
Sabkha	Sabkha	BH160	A-289
Salt Evaporator	Salt Evaporator	BH155	A-290
Salt Flat	Salt Flat	BH150	A-291
Salt Pan	Salt Flat	BH150	A-291
Sand	Soil Surface Region	DA010	A-306
Sand Dunes	Sand Dunes	DB170	A-292
Scattered Trees	Wood	EC030	A-357
School	General Building	AL015	A-124
Scrub	Thicket	EB020	A-329
Seaplane Anchorage/Base	Water Aerodrome	GB065	A-347
Seawall	Seawall	BB230	A-295
Settlement	Settlement	AL105	A-296
Settling Pond	Settling Pond	AC030	A-298
Shanty Town	Shanty Town	AL208	A-299
Shed	Shed	AL019	A-300
Shoreline	Land Water Boundary	BA010	A-171
Shoreline Construction	Berthing Structure	BB190	A-22
Shoreline Construction	Breakwater	BB041	A-25
Shoreline Construction	Groin	BB043	A-154
Shoreline Construction	Recreational Pier	AK190	A-247
Shoreline Construction	Seawall	BB230	A-295
Shoreline Construction	Training Wall	BB140	A-333
Shoreline Ramp	Slipway	BB240	A-303
Shrine	General Building	AL015	A-124
Siding, Railway	Railway Sidetrack	AN050	A-237
Signal Station, Maritime	Maritime Signal Station	BB155	A-178
Silo, Grain	Grain Storage Structure	AM020	A-150
Ski Jump	Ski Jump	AK150	A-301
Ski Lift	Cableway	AT041	A-35
Slipway	Slipway	BB240	A-303
Sluice Gate	Sluice Gate	BI040	A-304
Smokestack	Smokestack	AF010	A-305
Snow Ice Field	Snow Ice Field	BJ100	A-306
Snowshed	Protection Shed	AL210	A-205
Soil Surface Region	Soil Surface Region	DA010	A-306
Solar Panel	Solar Panel	AD020	A-309

**Sorted By DFDD Feature Name/Alternate Name**

29 May 2015

DFDD Feature Name / Alternate Name	DFDD Feature Name	Feature Code	Page
Spillway	Spillway	BH165	A-310
Sports Ground	Sports Ground	AK040	A-311
Spot Elevation	Spot Elevation	CA030	A-312
Spring	Natural Pool	BH170	A-187
Spring, Hot	Geothermal Outlet	DB115	A-146
Spur	Railway	AN010	A-216
Square, Public	Public Square	AL170	A-206
Stadium	Stadium	AK160	A-313
Station, Communication	Communication Station	AT050	A-57
Station, Electric Power	Electric Power Station	AD010	A-77
Station, Motor Vehicle	General Building	AL015	A-124
Station, Pumping	Pumping Station	AQ116	A-207
Station, Radar	Radar Station	AT045	A-215
Station, Transportation	Transportation Station	AQ125	A-334
Steep Terrain Face	Steep Terrain Face	DB010	A-315
Stockyard	Holding Pen	AJ030	A-163
Stopway	Stopway	GB045	A-316
Storage Bunker, Surface	Surface Bunker	AM060	A-322
Storage Depot	Storage Depot	AM010	A-316
Storage Facility, Fuel	Facility	AL010	A-110
Storage Tank	Storage Tank	AM070	A-318
Stream	River	BH140	A-254
Street	Road	AP030	A-257
Streetcar Line	Railway	AN010	A-216
Structural Pile	Structural Pile	BD100	A-321
Stupa	General Building	AL015	A-124
Substation, Power	Power Substation	AD030	A-201
Sugar Cane	Cane	EC010	A-44
Surface Bunker	Surface Bunker	AM060	A-322
Survey Point	Survey Point	ZB050	A-323
Swamp	Swamp	ED020	A-325
Swimming Pool	Swimming Pool	AK170	A-326
Synagogue	General Building	AL015	A-124
Tailings, Mine	Extraction Mine	AA010	A-102
Tank, Storage	Storage Tank	AM070	A-318
Taxiway	Taxiway	GB075	A-327
Telephone Line	Communication Line	AT060	A-55
Temple	General Building	AL015	A-124
Tent Dwellings	Camp Site	AK060	A-38
Test Site	Test Site	FA100	A-328
Thicket	Thicket	EB020	A-329

## Sorted By DFDD Feature Name/Alternate Name

29 May 2015

DFDD Feature Name / Alternate Name	DFDD Feature Name	Feature Code	Page
Tidal Water	Tidal Water	BA040	A-329
Tower	Tower	AL241	A-330
Tower, Control	Tower	AL241	A-330
Tower, Cooling	Tower	AL241	A-330
Tower, Water	Tower	AL241	A-330
Tower, Water Intake	Water Intake Tower	BI050	A-350
Track, Cart	Cart Track	AP010	A-44
Traffic Circle	Road	AP030	A-257
Trail	Trail	AP050	A-333
Training Wall	Training Wall	BB140	A-333
Tramway	Railway	AN010	A-216
Transformer Station	Power Substation	AD030	A-201
Transportation Route Protection Structure	Protection Shed	AL210	A-205
Transportation Station	Transportation Station	AQ125	A-334
Tree	Wood	EC030	A-357
Trees	Wood	EC030	A-357
Trees, Row of	Wood	EC030	A-357
Trench	Engineered Earthwork	AH025	A-100
Tundra	Tundra	BJ110	A-337
Tunnel	Tunnel	AQ130	A-338
Tunnel Mouth	Entrance and/or Exit	AQ090	A-101
Turbine, Wind	Wind Turbine	AJ051	A-356
Turntable, Railway	Railway Turntable	AN075	A-244
Underpass	Bridge	AQ040	A-27
Vanishing Point	Vanishing Point	BH145	A-341
Vehicle Lot	Vehicle Lot	AQ140	A-342
Vertical Obstruction	Vertical Obstruction	No Code	A-342
Viaduct	Bridge	AQ040	A-27
Vineyard	Vineyard	EA050	A-344
Void Collection Area	Void Collection Area	ZD020	A-345
Volcano	Volcano	DB180	A-345
Wadi	River	BH140	A-254
Wall	Wall	AL260	A-347
Water Aerodrome	Water Aerodrome	GB065	A-347
Water Gate	Water Gate	BI041	A-349
Water Intake Tower	Water Intake Tower	BI050	A-350
Water Race	Flume	BH060	A-120
Water Tower	Tower	AL241	A-330
Water Treatment Bed	Water Treatment Bed	BH040	A-350
Water Well	Well	AA050	A-352
Water, Open (Inland)	Lake	BH080	A-168

**Sorted By DFDD Feature Name/Alternate Name**

29 May 2015

DFDD Feature Name / Alternate Name	DFDD Feature Name	Feature Code	Page
Water, Open (Inland)	Reservoir	BH130	A-251
Water, Open (Tidal)	Tidal Water	BA040	A-329
Waterfall	Waterfall	BH180	A-351
Weir	Dam	BI020	A-67
Well	Well	AA050	A-352
Wharf	Berthing Structure	BB190	A-22
Wind Turbine	Wind Turbine	AJ051	A-356
Windmill	Windmill	AJ050	A-357
Wood	Wood	EC030	A-357
Woodland	Wood	EC030	A-357
Wreck	Wreck	BD180	A-361
Yard, Railway	Railway Yard	AN060	A-245
Zoo	Zoo	AK180	A-362

## Sorted by Feature Code

29 May 2015

Feature Code	DFDD Feature Name	Page
AA010	Extraction Mine	A-102
AA012	Quarry	A-210
AA040	Rig	A-254
AA050	Well	A-352
AA052	Hydrocarbons Field	A-165
AB000	Disposal Site	A-72
AB010	Recycling Site	A-248
AC000	Processing Facility	A-202
AC020	Catalytic Cracker	A-45
AC030	Settling Pond	A-298
AD010	Electric Power Station	A-77
AD020	Solar Panel	A-309
AD030	Power Substation	A-201
AD050	Heating Facility	A-158
AF010	Smokestack	A-305
AF020	Conveyor	A-59
AF040	Crane	A-61
AF070	Flare Pipe	A-120
AH025	Engineered Earthwork	A-100
AH050	Fortification	A-122
AH070	Checkpoint	A-53
AI030	Camp	A-37
AJ010	Circular Irrigation System	A-54
AJ030	Holding Pen	A-163
AJ050	Windmill	A-357
AJ051	Wind Turbine	A-356
AJ110	Greenhouse	A-153
AK030	Amusement Park	A-11
AK040	Sports Ground	A-311
AK060	Camp Site	A-38
AK090	Fairground	A-114
AK100	Golf Course	A-148
AK120	Park	A-190
AK130	Racetrack	A-214
AK150	Ski Jump	A-301
AK160	Stadium	A-313
AK170	Swimming Pool	A-326
AK180	Zoo	A-362
AK190	Recreational Pier	A-247
AL010	Facility	A-110
AL012	Archeological Site	A-19

## Sorted by Feature Code

29 May 2015

Feature Code	DFDD Feature Name	Page
AL015	General Building	A-124
AL019	Shed	A-300
AL020	Built Up Area	A-32
AL025	Cairn	A-36
AL030	Cemetery	A-47
AL060	Dragon's Teeth	A-75
AL070	Fence	A-115
AL099	Hut	A-164
AL105	Settlement	A-296
AL130	Memorial Monument	A-181
AL140	Particle Accelerator	A-192
AL170	Public Square	A-206
AL200	Ruins	A-286
AL208	Shanty Town	A-299
AL210	Protection Shed	A-205
AL241	Tower	A-330
AL260	Wall	A-347
AM010	Storage Depot	A-316
AM020	Grain Storage Structure	A-150
AM030	Grain Elevator	A-148
AM040	Mineral Pile	A-183
AM060	Surface Bunker	A-322
AM070	Storage Tank	A-318
AN010	Railway	A-216
AN050	Railway Sidetrack	A-237
AN060	Railway Yard	A-245
AN075	Railway Turntable	A-244
AN076	Roundhouse	A-285
AP010	Cart Track	A-44
AP030	Road	A-257
AP050	Trail	A-333
AQ040	Bridge	A-27
AQ063	Causeway Structure	A-46
AQ065	Culvert	A-65
AQ070	Ferry Crossing	A-115
AQ075	Ice Route	A-166
AQ090	Entrance and/or Exit	A-101
AQ110	Mooring Mast	A-185
AQ113	Pipeline	A-195
AQ116	Pumping Station	A-207
AQ125	Transportation Station	A-334

## Sorted by Feature Code

29 May 2015

Feature Code	DFDD Feature Name	Page
AQ130	Tunnel	A-338
AQ135	Roadside Rest Area	A-281
AQ140	Vehicle Lot	A-342
AT010	Dish Aerial	A-72
AT030	Power Line	A-200
AT041	Cableway	A-35
AT042	Pylon	A-209
AT045	Radar Station	A-215
AT050	Communication Station	A-57
AT060	Communication Line	A-55
BA010	Land Water Boundary	A-171
BA030	Island	A-167
BA040	Tidal Water	A-329
BA050	Beach	A-20
BB005	Harbour	A-157
BB041	Breakwater	A-25
BB043	Groin	A-154
BB090	Dry Dock	A-77
BB140	Training Wall	A-333
BB155	Maritime Signal Station	A-178
BB190	Berthing Structure	A-22
BB230	Seawall	A-295
BB240	Slipway	A-303
BD100	Structural Pile	A-321
BD110	Offshore Platform	A-189
BD120	Reef	A-249
BD130	Hazardous Rock	A-158
BD180	Wreck	A-361
BH010	Aqueduct	A-14
BH015	Bog	A-24
BH020	Canal	A-39
BH030	Ditch	A-73
BH040	Water Treatment Bed	A-350
BH050	Mariculture Site	A-177
BH051	Fish Farm Facility	A-118
BH060	Flume	A-120
BH070	Ford	A-121
BH080	Lake	A-168
BH090	Land Subject To Inundation	A-170
BH110	Penstock	A-193
BH120	Rapids	A-245



## Sorted by Feature Code

29 May 2015

Feature Code	DFDD Feature Name	Page
BH130	Reservoir	A-251
BH135	Rice Field	A-253
BH140	River	A-254
BH145	Vanishing Point	A-341
BH150	Salt Flat	A-291
BH155	Salt Evaporator	A-290
BH160	Sabkha	A-289
BH165	Spillway	A-310
BH170	Natural Pool	A-187
BH180	Waterfall	A-351
BI010	Cistern	A-54
BI020	Dam	A-67
BI030	Lock	A-174
BI040	Sluice Gate	A-304
BI041	Water Gate	A-349
BI050	Water Intake Tower	A-350
BJ020	Moraine	A-185
BJ030	Glacier	A-147
BJ031	Crevasse	A-61
BJ040	Ice Cliff	A-165
BJ060	Ice Peak	A-166
BJ100	Snow Ice Field	A-306
BJ110	Tundra	A-337
CA010	Elevation Contour	A-79
CA030	Spot Elevation	A-312
DA010	Soil Surface Region	A-306
DB010	Steep Terrain Face	A-315
DB029	Cave Mouth	A-47
DB061	Crevice	A-63
DB071	Cut Line	A-66
DB090	Embankment	A-98
DB100	Esker	A-101
DB110	Geologic Fault	A-143
DB115	Geothermal Outlet	A-146
DB150	Mountain Pass	A-186
DB160	Rock Formation	A-283
DB170	Sand Dunes	A-292
DB180	Volcano	A-345
DB200	Gully	A-156
EA010	Crop Land	A-64
EA020	Hedgerow	A-160

## Sorted by Feature Code

29 May 2015

Feature Code	DFDD Feature Name	Page
EA040	Orchard	A-190
EA050	Vineyard	A-344
EA055	Hop Field	A-164
EB010	Grassland	A-152
EB020	Thicket	A-329
EC010	Cane	A-44
EC020	Oasis	A-188
EC030	Wood	A-357
EC040	Cleared Way	A-55
EC060	Forest Clearing	A-122
ED010	Marsh	A-180
ED020	Swamp	A-325
ED030	Mangrove Swamp	A-176
FA000	Administrative Boundary	A-1
FA002	Geopolitical Entity	A-144
FA003	Administrative Division	A-3
FA015	Firing Range	A-116
FA090	Geophysical Prospecting Grid	A-144
FA100	Test Site	A-328
GA034	Aeronautical Radio Navigation Service	A-7
GB005	Land Aerodrome	A-169
GB015	Apron	A-14
GB030	Helipad	A-161
GB035	Heliport	A-162
GB040	Launch Pad	A-172
GB045	Stopway	A-316
GB050	Aircraft Revetment	A-10
GB055	Runway	A-287
GB065	Water Aerodrome	A-347
GB075	Taxiway	A-327
GB220	Aeronautical Obstacle	A-6
GB230	Aircraft Hangar	A-8
GB485	Approach Lighting System	A-13
No Code	Leader Line	A-173
No Code	Point of Change	A-199
No Code	River Flow Arrow	A-257
No Code	Road Route Marker	A-279
No Code	Vertical Obstruction	A-342
SU001	Military Installation	A-181
ZB050	Survey Point	A-323
ZD020	Void Collection Area	A-345

Feature Code

DFDD Feature Name

Page

ZD040

Named Location

A-186